

# Operating Instructions

## iTEMP TMT71

Temperature transmitter

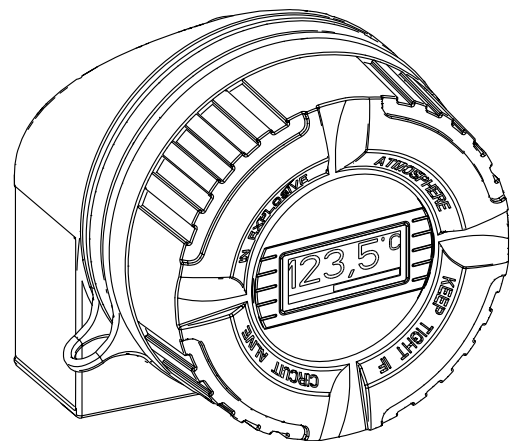

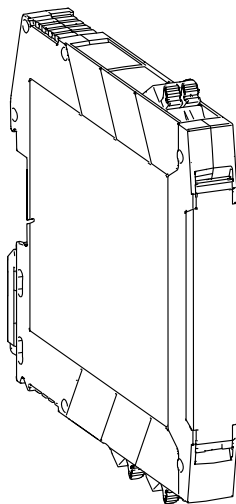
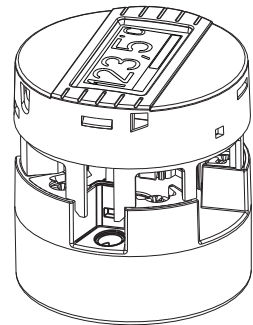
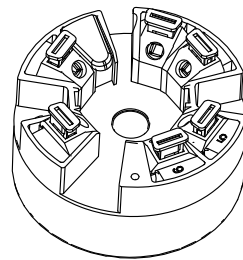
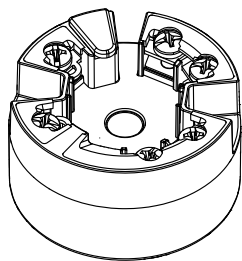

## Table of contents

<b>1</b>	<b>About this document</b> .....	<b>4</b>	8.4	Protecting settings from unauthorized access .....	34
1.1	Document function .....	4	<b>9</b>	<b>Diagnostics and troubleshooting</b> ...	<b>36</b>
1.2	Safety Instructions (XA) .....	4	9.1	General troubleshooting .....	36
1.3	Symbols used .....	4	9.2	Diagnostic information on local display .....	38
1.4	Tool symbols .....	6	9.3	Diagnostic information via communication interface .....	38
1.5	Documentation .....	6	9.4	Diagnostic list .....	39
<b>2</b>	<b>Basic safety instructions</b> .....	<b>7</b>	9.5	Event logbook .....	39
2.1	Requirements for the personnel .....	7	9.6	Overview of diagnostic events .....	39
2.2	Designated use .....	7	9.7	Firmware history .....	41
2.3	Operational safety .....	7	<b>10</b>	<b>Maintenance</b> .....	<b>41</b>
<b>3</b>	<b>Incoming acceptance and product identification</b> .....	<b>8</b>	<b>11</b>	<b>Repair</b> .....	<b>41</b>
3.1	Incoming acceptance .....	8	11.1	General information .....	41
3.2	Product identification .....	8	11.2	Spare parts .....	42
3.3	Scope of delivery .....	9	11.3	Return .....	42
3.4	Certificates and approvals .....	10	11.4	Disposal .....	42
3.5	Transport and storage .....	10	<b>12</b>	<b>Accessories</b> .....	<b>42</b>
<b>4</b>	<b>Installation</b> .....	<b>11</b>	12.1	Device-specific accessories .....	42
4.1	Installation conditions .....	11	12.2	Communication-specific accessories .....	43
4.2	Installation .....	11	12.3	Service-specific accessories .....	43
4.3	Post-installation check .....	16	12.4	System components .....	44
<b>5</b>	<b>Electrical connection</b> .....	<b>17</b>	<b>13</b>	<b>Technical data</b> .....	<b>45</b>
5.1	Connection conditions .....	17	13.1	Input .....	45
5.2	Quick wiring guide .....	18	13.2	Output .....	46
5.3	Connecting the sensor cables .....	18	13.3	Power supply .....	46
5.4	Connecting the transmitter .....	19	13.4	Performance characteristics .....	47
5.5	Post-connection check .....	21	13.5	Environment .....	54
<b>6</b>	<b>Operation options</b> .....	<b>22</b>	13.6	Mechanical construction .....	55
6.1	Overview of operation options .....	22	13.7	Certificates and approvals .....	58
6.2	Structure and function of the operating menu .....	25	13.8	Supplementary documentation .....	60
6.3	Access to the operating menu via the operating tool .....	27	<b>14</b>	<b>Operating menu and parameter description</b> .....	<b>61</b>
6.4	Access to the operating menu via the SmartBlue app .....	29	14.1	Menu: Diagnostics .....	64
<b>7</b>	<b>System integration</b> .....	<b>31</b>	14.2	Menu: Application .....	70
7.1	Overview of device description files .....	31	14.3	Menu: System .....	79
7.2	Measured variables .....	31	<b>Index</b> .....	<b>91</b>	
<b>8</b>	<b>Commissioning</b> .....	<b>32</b>			
8.1	Post-installation check .....	32			
8.2	Switching on the transmitter .....	32			
8.3	Configuring the measuring device .....	32			

# 1 About this document

## 1.1 Document function





These Operating Instructions contain all the information that is required in various phases of the life cycle of the device: from product identification, incoming acceptance and storage, to mounting, connection, operation and commissioning through to troubleshooting, maintenance and disposal.

## 1.2 Safety Instructions (XA)



When using in hazardous areas, compliance with national regulations is mandatory. Separate Ex-specific documentation is provided for measuring systems that are used in hazardous areas. This documentation is an integral part of these Operating Instructions. The installation specifications, connection data and safety instructions it contains must be strictly observed! Make sure that you use the right Ex-specific documentation for the right device with approval for use in hazardous areas! The number of the specific Ex documentation (XA...) is provided on the nameplate. If the two numbers (on the Ex documentation and the nameplate) are identical, then you may use this Ex-specific documentation.



## 1.3 Symbols used

### 1.3.1 Safety symbols













Symbol	Meaning
	<b>DANGER!</b> This symbol alerts you to a dangerous situation. Failure to avoid this situation will result in serious or fatal injury.
	<b>WARNING!</b> This symbol alerts you to a dangerous situation. Failure to avoid this situation can result in serious or fatal injury.
	<b>CAUTION!</b> This symbol alerts you to a dangerous situation. Failure to avoid this situation can result in minor or medium injury.
	<b>NOTE!</b> This symbol contains information on procedures and other facts which do not result in personal injury.

### 1.3.2 Electrical symbols



Symbol	Meaning
	Direct current
	Alternating current
	Direct current and alternating current

Symbol	Meaning
	<b>Ground connection</b> A grounded terminal which, as far as the operator is concerned, is grounded via a grounding system.
	<b>Protective Earth (PE)</b> A terminal which must be connected to ground prior to establishing any other connections. The ground terminals are situated inside and outside the device: <ul style="list-style-type: none"> <li>▪ Inner ground terminal: Connects the protective earth to the mains supply.</li> <li>▪ Outer ground terminal: Connects the device to the plant grounding system.</li> </ul>





### 1.3.3 Symbols for certain types of information

Symbol	Meaning
	<b>Permitted</b> Procedures, processes or actions that are permitted.
	<b>Preferred</b> Procedures, processes or actions that are preferred.
	<b>Forbidden</b> Procedures, processes or actions that are forbidden.
	<b>Tip</b> Indicates additional information.
	Reference to documentation.
	Reference to page.
	Reference to graphic.
	Notice or individual step to be observed.
	Series of steps.
	Result of a step.
	Help in the event of a problem.
	Visual inspection.

### 1.3.4 Symbols in graphics

Symbol	Meaning	Symbol	Meaning
1, 2, 3,...	Item numbers		Series of steps
A, B, C, ...	Views	A-A, B-B, C-C, ...	Sections
	Hazardous area		Safe area (non-hazardous area)

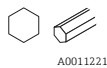
## 1.4 Tool symbols

Symbol	Meaning
 A0011220	Flat blade screwdriver
 A0011219	Phillips head screwdriver
 A0011221	Allen key
 A0011222	Open-ended wrench
 A0013442	Torx screwdriver

## 1.5 Documentation

Document	Purpose and content of the document
Technical Information TI01393T/09/en	<b>Planning aid for your device</b> The document contains all the technical data on the device and provides an overview of the accessories and other products that can be ordered for the device.
Brief Operating Instructions KA01414T/09/en	<b>Guide that takes you quickly to the 1st measured value</b> The Brief Operating Instructions contain all the essential information from incoming acceptance to initial commissioning.

 The document types listed are available:  
In the Download Area of the Endress+Hauser Internet site: [www.endress.com](http://www.endress.com) →  
Download

## 2 Basic safety instructions

### 2.1 Requirements for the personnel

The personnel for installation, commissioning, diagnostics and maintenance must fulfill the following requirements:

- ▶ Trained, qualified specialists must have a relevant qualification for this specific function and task
- ▶ Are authorized by the plant owner/operator
- ▶ Are familiar with federal/national regulations
- ▶ Before beginning work, the specialist staff must have read and understood the instructions in the Operating Instructions and supplementary documentation as well as in the certificates (depending on the application)
- ▶ Following instructions and basic conditions

The operating personnel must fulfill the following requirements:

- ▶ Being instructed and authorized according to the requirements of the task by the facility's owner-operator
- ▶ Following the instructions in these Operating Instructions

### 2.2 Designated use

The device is a universal and user-configurable temperature transmitter with one sensor input for a resistance thermometer (RTD), thermocouples (TC), resistance and voltage transmitters. The head transmitter version of the device is intended for mounting in a terminal head (flat face) as per DIN EN 50446. It is also possible to mount the device on a DIN rail using the optional DIN rail clip. The device is also optionally available in a version suitable for DIN rail mounting as per IEC 60715 (TH35).

If the equipment is used in a manner not specified by the manufacturer, the protection provided by the equipment may be impaired.

The manufacturer is not liable for damage caused by improper or non-designated use.

### 2.3 Operational safety

- ▶ Operate the device in proper technical condition and fail-safe condition only.
- ▶ The operator is responsible for interference-free operation of the device.

#### **Hazardous area**

To eliminate a danger for persons or for the facility when the device is used in the hazardous area (e.g. explosion protection or safety equipment):

- ▶ Based on the technical data on the nameplate, check whether the ordered device is permitted for the intended use in the hazardous area. The nameplate can be found on the side of the transmitter housing.
- ▶ Observe the specifications in the separate supplementary documentation that is an integral part of these Instructions.

#### **Electromagnetic compatibility**

The measuring system complies with the general safety requirements as per EN 61010-1, the EMC requirements as per the IEC/EN 61326 series and the NAMUR recommendations NE 21.

#### **NOTICE**

- ▶ The device must only be powered by a power unit that operates using an energy-limited electric circuit according to UL/EN/IEC 61010-1, chapter 9.4 and requirements of table 18.

## 3 Incoming acceptance and product identification

### 3.1 Incoming acceptance

1. Unpack the temperature transmitter carefully. Is the packaging or content damaged?
  - ↳ Damaged components may not be installed as the manufacturer can otherwise not guarantee compliance with the original safety requirements or the material resistance, and can therefore not be held responsible for any resulting damage.
2. Is the delivery complete or is anything missing? Check the scope of delivery against your order.

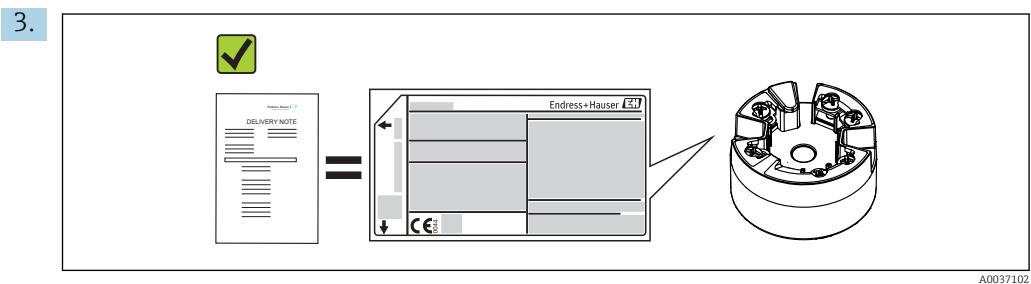

Does the nameplate match the ordering information on the delivery note?

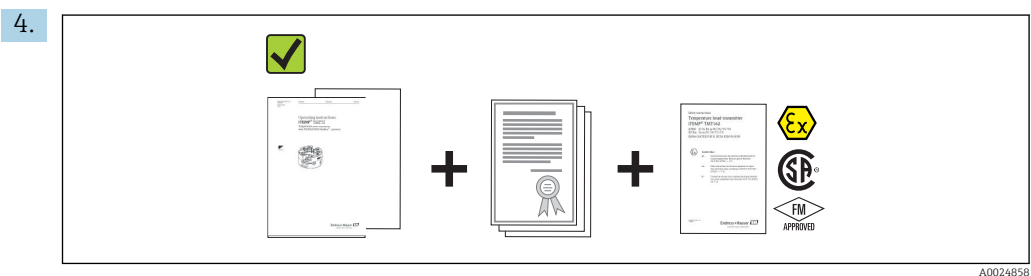

Are the technical documentation and all other necessary documents provided? If applicable: are the Safety Instructions (e.g. XA) for hazardous areas provided?

**i** If one of these conditions is not satisfied, contact your Endress+Hauser Sales Center.

### 3.2 Product identification

The following options are available for identification of the device:

- Nameplate specifications
- Extended order code with breakdown of the device features on the delivery note
- Enter the serial number from the nameplate in the *W@M Device Viewer* ([www.endress.com/deviceviewer](http://www.endress.com/deviceviewer)): All data relating to the device and an overview of the Technical Documentation supplied with the device are displayed.
- Enter the serial number on the nameplate into the *Endress+Hauser Operations App* or scan the 2-D matrix code (QR code) on the nameplate with the *Endress+Hauser Operations App*: all the information about the device and the technical documentation pertaining to the device is displayed.

#### 3.2.1 Nameplate

##### The right device?

Compare and check the data on the nameplate of the device against the requirements of the measuring point:



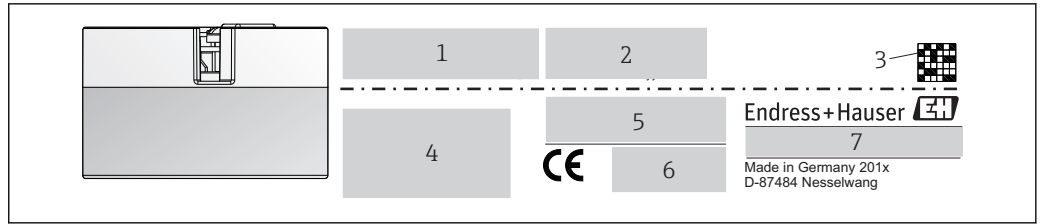

A0014561

1 Nameplate of the head transmitter (example, Ex version)

- 1 Power supply, current consumption and radio approval (Bluetooth)
- 2 Serial number, device revision, firmware version and hardware version
- 3 Data Matrix 2D code
- 4 2 lines for the TAG name and extended order code
- 5 Approval in hazardous area with number of the relevant Ex documentation (XA...)
- 6 Approvals with symbols
- 7 Order code and manufacturer ID

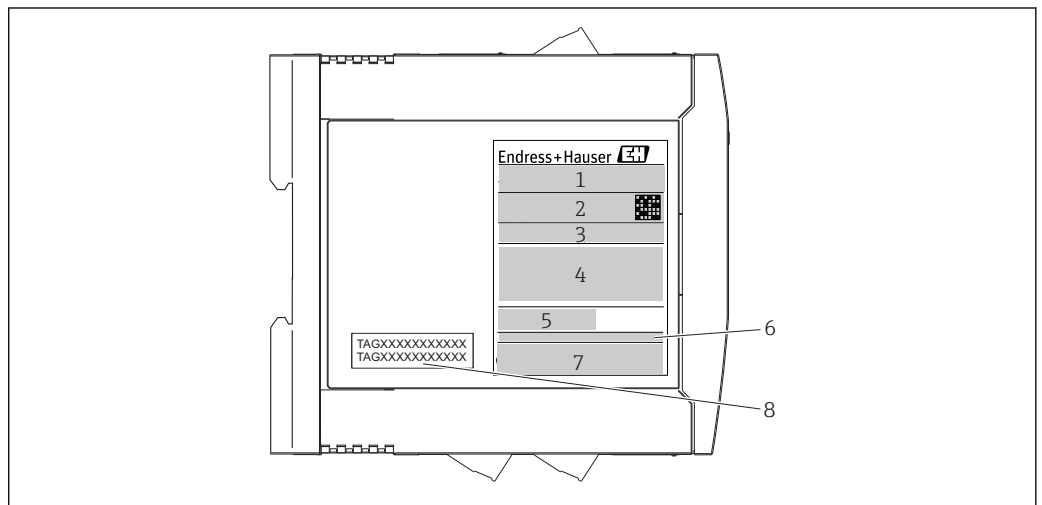

A0017924

2 Nameplate of DIN rail transmitter (example, Ex version)

- 1 Product name and manufacturer ID
- 2 Order code, extended order code and serial number, Data Matrix 2D code, FCC-ID (if applicable)
- 3 Power supply and current consumption, output
- 4 Approval in hazardous area with number of the relevant Ex documentation (XA...)
- 5 Fieldbus communication logo
- 6 Firmware version and device revision
- 7 Approval logos
- 8 2 lines for the TAG name

### 3.2.2 Name and address of manufacturer

<b>Name of manufacturer:</b>	Endress+Hauser Wetzer GmbH + Co. KG
<b>Address of manufacturer:</b>	Obere Wank 1, D-87484 Nesselwang oder <a href="http://www.endress.com">www.endress.com</a>
<b>Address of manufacturing plant:</b>	See nameplate

### 3.3 Scope of delivery

The scope of delivery of the device comprises:

- Temperature transmitter
- Mounting material (head transmitter), optional
- Hard copy of multi-language Brief Operating Instructions
- Additional documentation for devices which are suitable for use in the hazardous area (Ex, ATEX, IECEx), such as Safety Instructions (XA...), Control or Installation Drawings (ZD...).

## 3.4 Certificates and approvals



The device left the factory in a safe operating condition. The device complies with the requirements of the standards EN 61 010-1 "Safety Requirements for Electrical Equipment for Measurement, Control, and Laboratory Use" and with the EMC requirements as per the IEC/EN 61326 series.

### 3.4.1 CE/EAC mark, declaration of conformity

The device meets the legal requirements of the EU/EEU guidelines. The manufacturer confirms that the device is compliant with the relevant guidelines by applying the CE/EAC mark.

## 3.5 Transport and storage

Carefully remove all the packaging material and protective covers that are part of the transported package.

 Dimensions and operating conditions: →  55

When storing (and transporting) the device, pack it so that it is reliably protected against impact. The original packaging offers the best protection.

Storage temperature

- Head transmitter: -50 to +100 °C (-58 to +212 °F)
- DIN rail device: -50 to +100 °C (-58 to +212 °F)

## 4 Installation



### 4.1 Installation conditions

#### 4.1.1 Dimensions

The dimensions of the device are provided in the "Technical data" section →  55.

#### 4.1.2 Mounting location

- Head transmitter:
  - In the terminal head, flat face, as per DIN EN 50446, direct mounting on insert with cable entry (middle hole 7 mm)
  - In the field housing, separated from the process →  42
- DIN rail transmitter:  
Designed for mounting on a DIN rail (IEC 60715 TH35).

 It is also possible to mount the head transmitter on a DIN rail as per IEC 60715 using the DIN rail clip →  42 accessory.

Information about the conditions (such as the ambient temperature, degree of protection, climate class etc.) that must be present at the installation point so that the device can be mounted correctly is provided in the "Technical data" section →  54.

When using in hazardous areas, the limit values of the certificates and approvals must be observed (see Ex Safety Instructions).

#### NOTICE

**When using DIN rail transmitters with a thermocouple/mV measurement, increased measurement deviations may occur depending on the installation situation and ambient conditions.**

- ▶ If the DIN rail transmitter is mounted on the DIN rail without any adjacent devices, this may result in deviations of up to  $\pm 1.34$  °C. If the DIN rail transmitter is mounted in series between other DIN rail devices (reference operating conditions: 24 V, 12 mA), deviations of up to + 2.94 °C may occur.

### 4.2 Installation

A Phillips head screwdriver is required to mount the head transmitter.

- Maximum torque for securing screws = 1 Nm ( $\frac{3}{4}$  foot-pound), screwdriver: Pozidriv Z2
- Maximum torque for screw terminals = 0.35 Nm ( $\frac{1}{4}$  foot-pound), screwdriver: Pozidriv Z1

### 4.2.1 Mounting the head transmitter

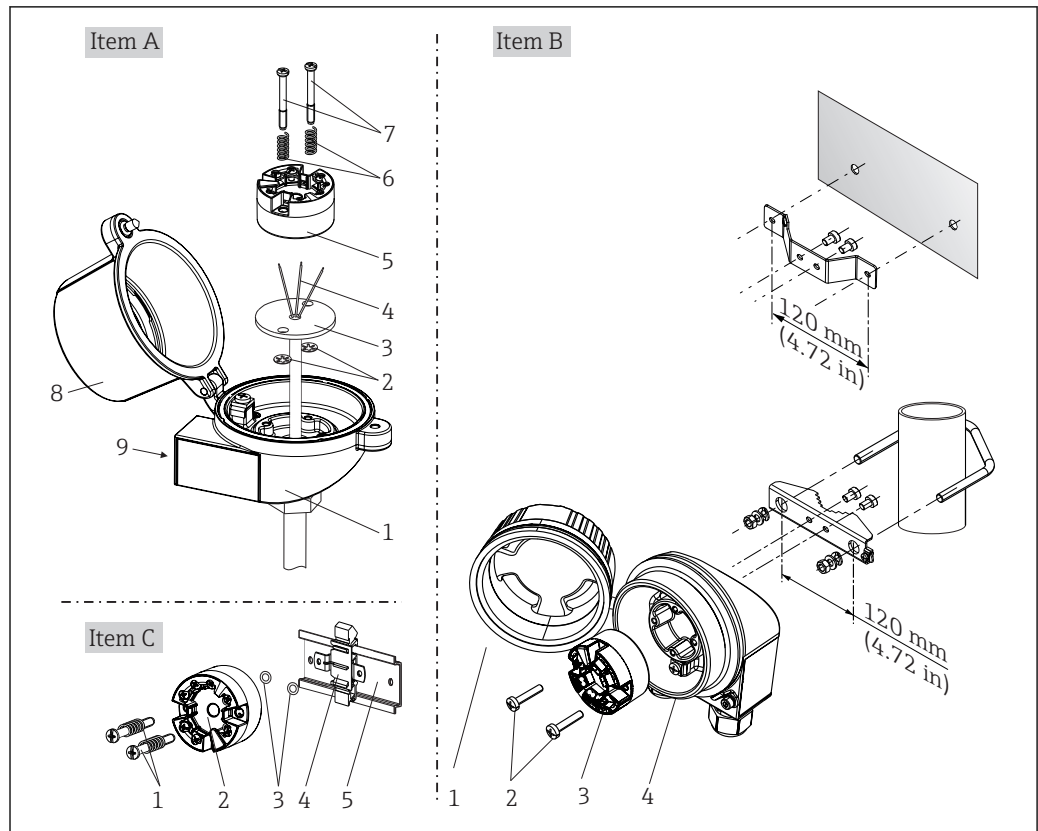

A0039675-EN

3 Head transmitter mounting (three versions)

Fig. A	Mounting in a terminal head (terminal head flat face as per DIN 43729)
1	Terminal head
2	Circlips
3	Insert
4	Connection wires
5	Head transmitter
6	Mounting springs
7	Mounting screws
8	Terminal head cover
9	Cable entry

Procedure for mounting in a terminal head, Fig. A:

1. Open the terminal head cover (8) on the terminal head.
2. Guide the connection wires (4) of the insert (3) through the center hole in the head transmitter (5).
3. Fit the mounting springs (6) on the mounting screws (7).
4. Guide the mounting screws (7) through the side boreholes of the head transmitter and the insert (3). Then fix both mounting screws with the snap rings (2).
5. Then tighten the head transmitter (5) along with the insert (3) in the terminal head.
6. After wiring → 17, close the terminal head cover (8) tightly again.

Fig. B	Mounting in a field housing
1	Field housing cover
2	Mounting screws with springs
3	Head transmitter
5	Field housing

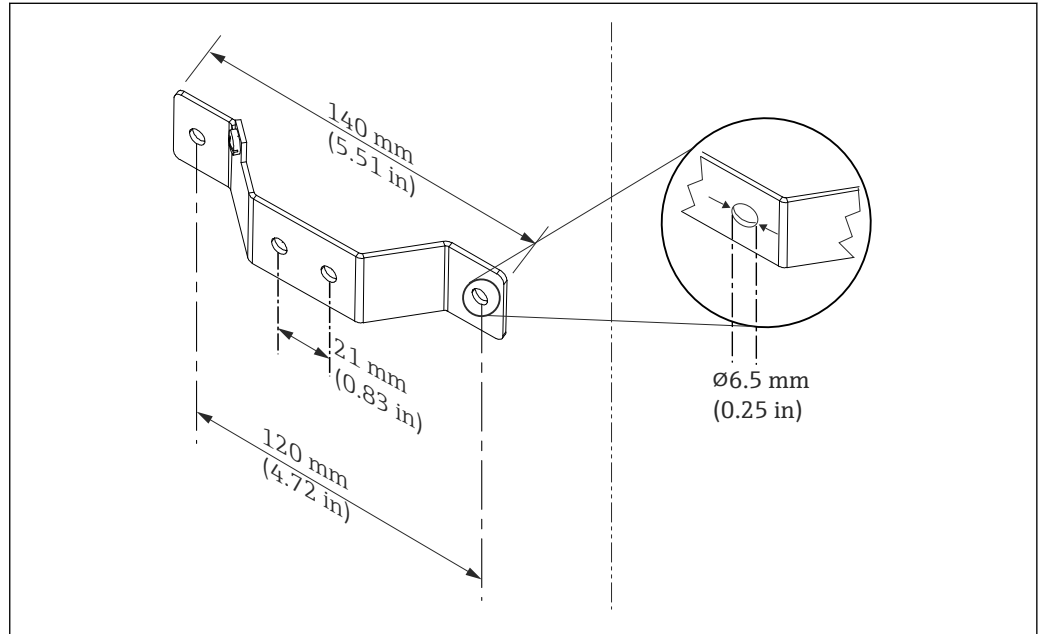

4 Dimensions of angle bracket for wall mount (complete wall mounting set available as accessory)

Procedure for mounting in a field housing, Fig. B:

1. Open the cover (1) of the field housing (4).
2. Guide the mounting screws (2) through the lateral bores in the head transmitter (3).
3. Screw the head transmitter to the field housing.
4. After wiring, close the field housing cover (1) → 17 again.

Fig. C	Mounting on DIN rail (DIN rail as per IEC 60715)
1	Mounting screws with springs
2	Head transmitter
3	Circlips
4	DIN rail clip
5	DIN rail

Procedure for mounting on a DIN rail, Fig. C:

1. Press the DIN rail clip (4) onto the DIN rail (5) until it engages with a click.
2. Fit the mounting springs on the mounting screws (1) and guide the screws through the side boreholes of the head transmitter (2). Then fix both mounting screws with the snap rings (3).
3. Screw the head transmitter (2) onto the DIN rail clip (4).

### Mounting typical of North America

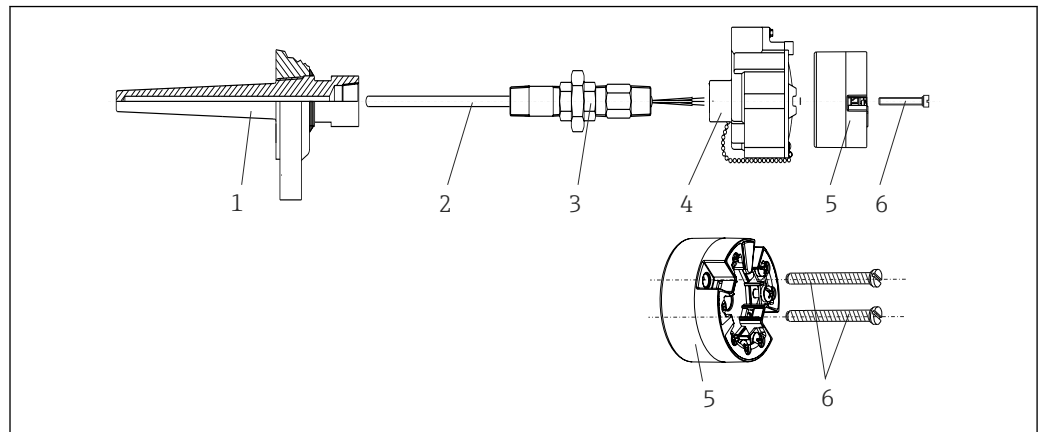

A0008520

#### 5 Head transmitter mounting

- 1 Thermowell
- 2 Insert
- 3 Adapter, coupling
- 4 Terminal head
- 5 Head transmitter
- 6 Mounting screws

Thermometer design with thermocouples or RTD sensors and head transmitter:

1. Fit the thermowell (1) on the process pipe or the container wall. Secure the thermowell according to the instructions before the process pressure is applied.
2. Fit the necessary neck tube nipples and adapter (3) on the thermowell.
3. Make sure sealing rings are installed if such rings are needed for harsh environmental conditions or special regulations.
4. Guide the mounting screws (6) through the lateral bores of the head transmitter (5).
5. Position the head transmitter (5) in the terminal head (4) in such a way that the bus cable (terminals 1 and 2) point to the cable entry.
6. Using a screwdriver, screw down the head transmitter (5) in the terminal head (4).
7. Guide the connection wires of the insert (3) through the lower cable entry of the terminal head (4) and through the middle hole in the head transmitter (5). Wire the connection wires up to the transmitter → 18.
8. Screw the terminal head (4), with the integrated and wired head transmitter, onto the ready-mounted nipple and adapter (3).

#### NOTICE

**The terminal head cover must be secured properly to meet the requirements for explosion protection.**

- ▶ After wiring, securely screw the terminal head cover back on.

### Mounting the display on the head transmitter

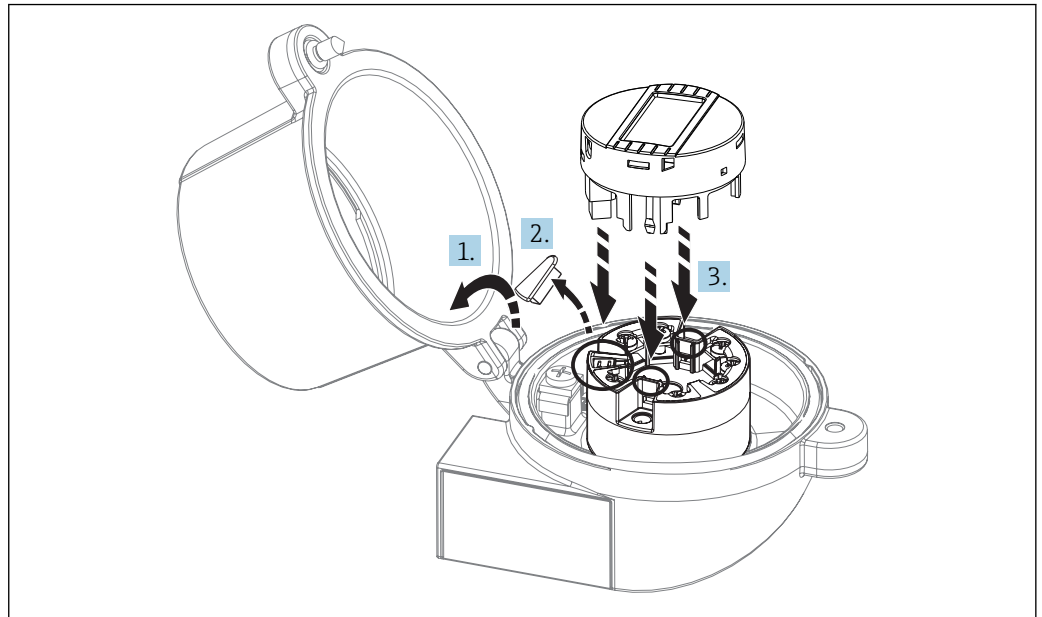

A0009852

#### 6 Mounting the display

1. Loosen the screw on the terminal head cover. Flip back the terminal head cover.
2. Remove the cover of the display connection area.
3. Fit the display module onto the mounted and wired head transmitter. The fastening pins must click securely into place on the head transmitter. After mounting, securely tighten the terminal head cover.

**i** The display can be used only with the appropriate terminal heads - cover with viewing window (e.g. TA30 from Endress+Hauser).

### 4.2.2 Mounting the DIN rail transmitter

#### NOTICE

##### Wrong orientation

Measurement deviates from the maximum accuracy rating when a thermocouple is connected and the internal reference junction is used.

- Mount the device vertically and ensure it is oriented correctly!

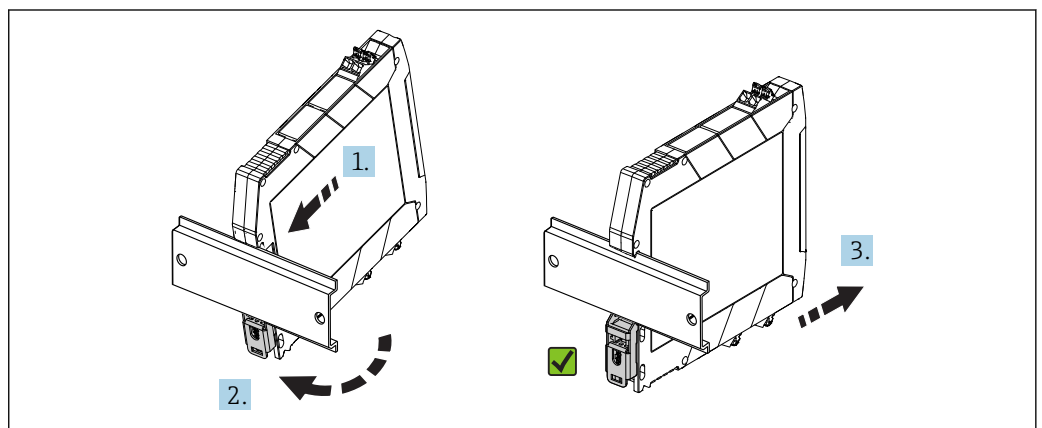

A0039678

#### 7 Mounting the DIN rail transmitter

1. Position the top DIN rail groove at the top end of the DIN rail.
2. Slide the bottom of the device over the bottom end of the DIN rail until you can hear the lower DIN rail clip click into place on the DIN rail.
3. Pull gently on the device to check if it is correctly mounted on the DIN rail.

If it doesn't move, the DIN rail transmitter is correctly mounted.

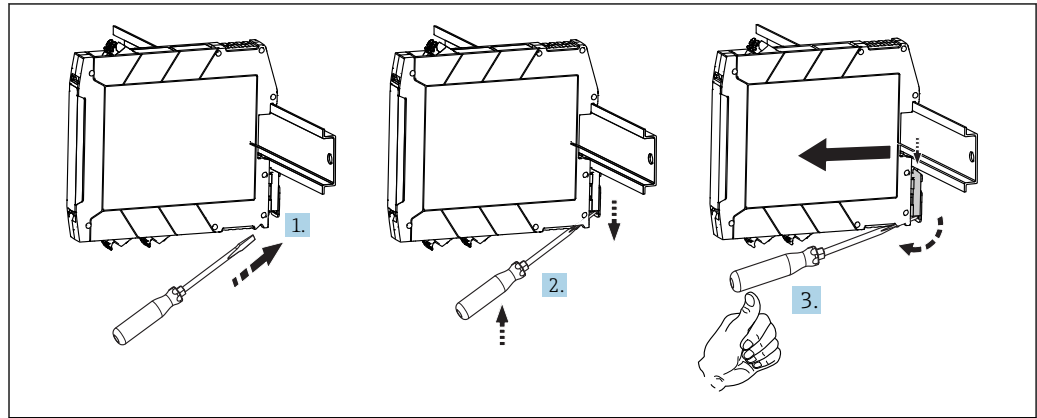

A0039696

8 Dismantling the DIN rail transmitter

Dismantling the DIN rail transmitter:

1. Insert a screwdriver into the tab of the DIN rail clip.
2. Use the screwdriver to pull down on the DIN rail clip as shown in the diagram.
3. Hold down the screwdriver to remove the device from the DIN rail.

### 4.3 Post-installation check

After installing the device, always run the following final checks:

Device condition and specifications	Notes
Is the device undamaged (visual inspection)?	-
Do the ambient conditions match the device specification (e.g. ambient temperature, measuring range, etc.)?	See 'Technical data' section



## 5 Electrical connection



### **⚠ CAUTION**

- ▶ Switch off the power supply before installing or connecting the device. Failure to observe this may result in the destruction of parts of the electronics.
- ▶ Do not occupy the display connection. An incorrect connection can destroy the electronics.

### 5.1 Connection conditions

A Phillips head screwdriver is required to wire the head transmitter with screw terminals. Use a flat blade screwdriver for the DIN rail housing version with screw terminals. The push-in terminal version can be wired without any tools.

Proceed as follows to wire a mounted head transmitter:

1. Open the cable gland and the housing cover on the terminal head or the field housing.
2. Feed the cables through the opening in the cable gland.
3. Connect the cables as shown in →  18. If the head transmitter is fitted with push-in terminals, pay particular attention to the information in the "Connecting to push-in terminals" section. →  19
4. Tighten the cable gland again and close the housing cover.

In order to avoid connection errors always follow the instructions in the post-connection check section before commissioning!

## 5.2 Quick wiring guide

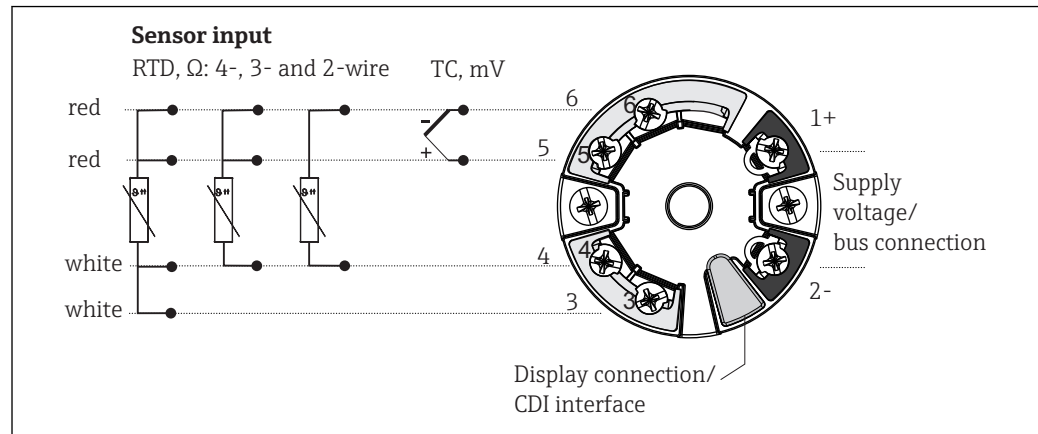

9 Terminal assignment of head transmitter

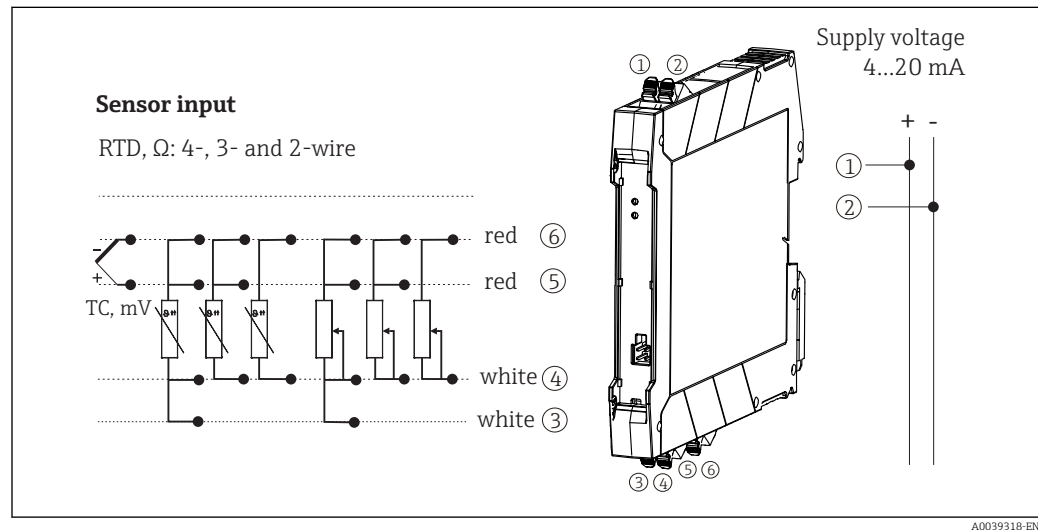

10 Assignment of terminal connections for DIN rail transmitter

In the event of a thermocouple (TC) measurement, a 2-wire RTD can be connected to measure the reference junction temperature. This is connected to terminals 4 and 6.

### NOTICE

- ▶ ESD - electrostatic discharge. Protect the terminals from electrostatic discharge. Failure to observe this may result in the destruction or malfunction of parts of the electronics.

## 5.3 Connecting the sensor cables

Terminal assignment of the sensor connections → 9, 18.

### 5.3.1 Connecting to push-in terminals

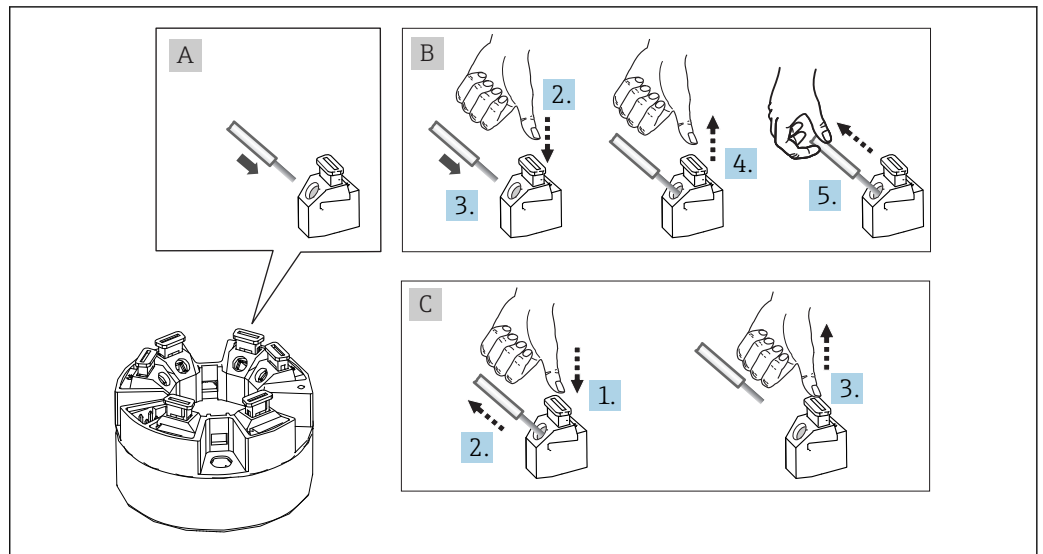

Fig. 11 Push-in terminal connection, using the example of a head transmitter

#### Fig. A, solid wire:

1. Strip wire end. Min. stripping length 10 mm (0.39 in).
2. Insert the wire end into the terminal.
3. Pull the wire gently to ensure it is connected correctly. Repeat from step 1 if necessary.

#### Fig. B, fine-strand wire without ferrule:

1. Strip wire end. Min. stripping length 10 mm (0.39 in).
2. Press down on the lever opener.
3. Insert the wire end into the terminal.
4. Release lever opener.
5. Pull the wire gently to ensure it is connected correctly. Repeat from step 1 if necessary.

#### Fig. C, Releasing the connection:

1. Press down on the lever opener.
2. Remove the wire from the terminal.
3. Release lever opener.

## 5.4 Connecting the transmitter

### **i** Cable specification

- A normal device cable suffices if only the analog signal is used.
- In the case of the DIN rail version, a shielded cable must be used if the sensor cable length exceeds 30 m (98.4 ft). The use of shielded sensor cables is generally recommended.

Please also observe the general procedure on → Fig. 17.

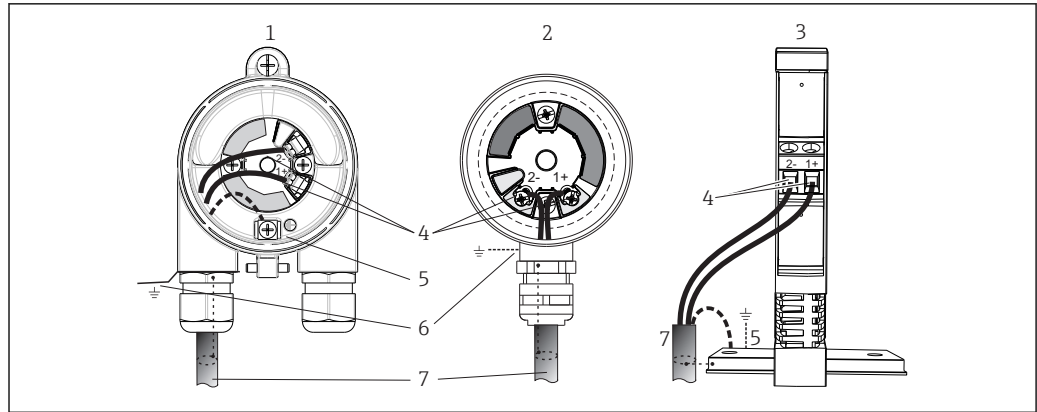

A0039698

**12** Connecting the signal cables and power supply

- 1 Head transmitter installed in field housing
- 2 Head transmitter installed in terminal head
- 3 DIN rail transmitter mounted on DIN rail
- 4 Terminals for power supply
- 5 Internal ground connection
- 6 External ground connection
- 7 Shielded signal cable (recommended for

- i** The terminals for the power supply (1+ and 2-) are protected against reverse polarity.
- Conductor cross-section:
  - Max. 2.5 mm<sup>2</sup> for screw terminals
  - Max. 1.5 mm<sup>2</sup> for push-in terminals. Min. stripping length of cable 10 mm (0.39 in).

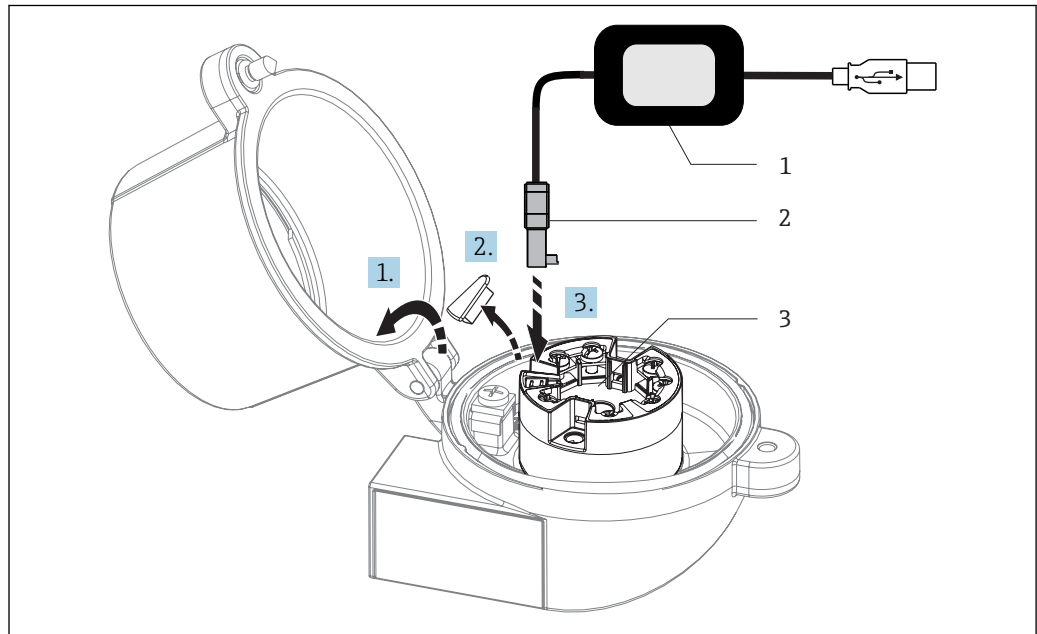

A0037914

**13** Fitting the CDI connector of the configuration kit for configuration, visualization and maintenance of the head transmitter via PC and configuration software

- 1 Configuration kit, e.g. TXU10 with USB connection
- 2 CDI connector
- 3 Installed head transmitter with CDI interface

## 5.5 Post-connection check

Device condition and specifications	Notes
Is the device or cable undamaged (visual check)?	--
Electrical connection	Notes
Does the supply voltage match the specifications on the nameplate?	<ul style="list-style-type: none"> <li>▪ Head transmitter: <math>U = \text{e.g. } 10 \text{ to } 36 \text{ V}_{\text{DC}}</math></li> <li>▪ Other values apply in the hazardous area, see the corresponding Ex Safety Instructions (XA).</li> <li>▪ DIN rail transmitter: <math>U = \text{e.g. } 11 \text{ to } 36 \text{ V}_{\text{DC}}</math></li> </ul>
Do the cables have adequate strain relief?	--
Are the power supply and signal cables correctly connected?	→  18
Are all the screw terminals well tightened and have the connections of the push-in terminals been checked?	--
Are all the cable entries installed, tightened and sealed?	--
Are all housing covers installed and firmly tightened?	--

## 6 Operation options

### 6.1 Overview of operation options

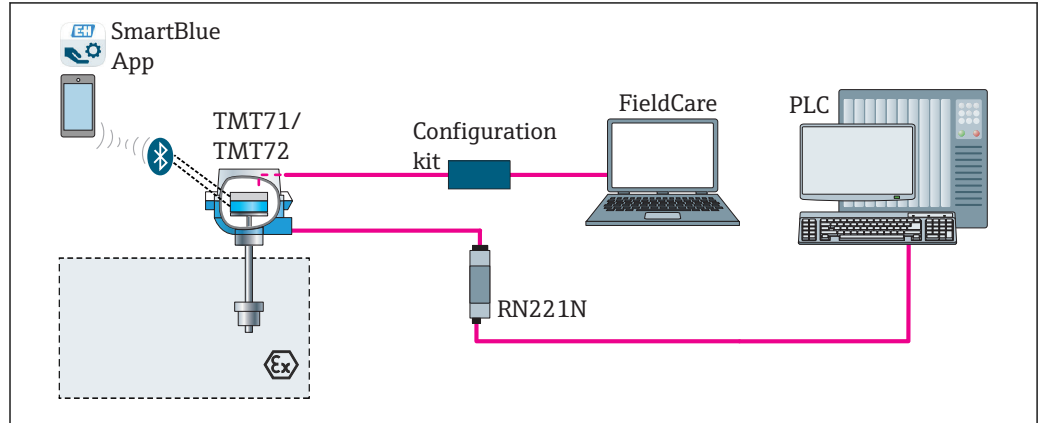

A0037893

14 Operation options for the transmitter via the CDI interface

**i** The transmitter's optional Bluetooth interface is only active if a display unit is not attached or the CDI interface is not used for device configuration.

#### 6.1.1 Measured value display and operating elements

##### Option: Display TID10 for head transmitter

**b** The display may also be subsequently ordered at any time after purchasing the transmitter, see the 'Accessories' section in the Operating Instructions for the device.

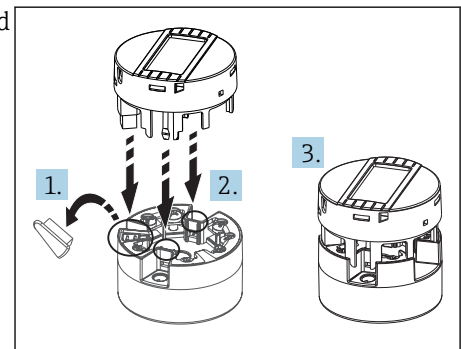

A0010227

15 Attach the display to the transmitter

#### Display elements

##### Head transmitter

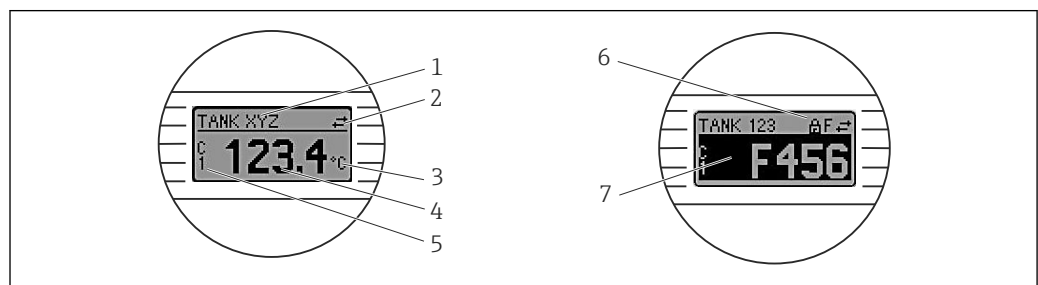

A0008549

16 Optional LC display for head transmitter

Item no.	Function	Description
1	Displays the TAG	TAG, 32 characters long.
2	'Communication' symbol	The communication symbol appears when read and write-accessing via the fieldbus protocol.
3	Unit display	Unit display for the measured value displayed.
4	Measured value display	Displays the current measured value.
5	Value/channel display DT, PV, I, %	e.g. PV for a measured value from channel 1 or DT for the device temperature
6	'Configuration locked' symbol	The 'configuration locked' symbol appears when configuration is locked via the hardware.
7	Status signals	
	Symbols	Meaning
	<b>F</b>	<b>Error message "Failure detected"</b> An operating error has occurred. The measured value is no longer valid. The display alternates between the error message and "- - -" (no valid measured value present), see "Diagnostics events" section → 38. Detailed information on the error messages can be found in the Operating Instructions.
	<b>C</b>	<b>"Service mode"</b> The device is in service mode (e.g. during a simulation).
	<b>S</b>	<b>"Out of specification"</b> The device is being operated outside its technical specifications (e.g. during warm-up or cleaning processes).
<b>M</b>	<b>"Maintenance required"</b> Maintenance is required. The measured value is still valid. The display alternates between the measured value and the status message.	

### DIN rail transmitter

Two LEDs on the front indicate the device status.

Type	Function and characteristic
Status LED (red)	When the device is operating without errors, the device status is displayed. This function can no longer be guaranteed in the event of an error. <ul style="list-style-type: none"> <li>LED off: without diagnostic message</li> <li>LED is lit: diagnostics display, category F</li> <li>LED flashing: diagnostics display of categories C, S or M</li> </ul>
Power LED (green) 'ON'	When the device is operating without errors, the operating status is displayed. This function can no longer be guaranteed in the event of an error. <ul style="list-style-type: none"> <li>LED off: Power failure or insufficient supply voltage</li> <li>LED is lit: Supply voltage is OK (either via CDI or via supply voltage, terminals 1+, 2-)</li> </ul>

 The DIN rail transmitter version does not have an interface to the LC display and therefore does not have a local display either.

### Local operation

You can make various hardware settings using miniature switches (DIP switches) on the rear of the optional display.

 The user has the option of ordering the display with the head transmitter, or as an accessory for subsequent mounting. → 42

**NOTICE**

- ▶  ESD - electrostatic discharge. Protect the terminals from electrostatic discharge. Failure to observe this may result in the destruction or malfunction of parts of the electronics.

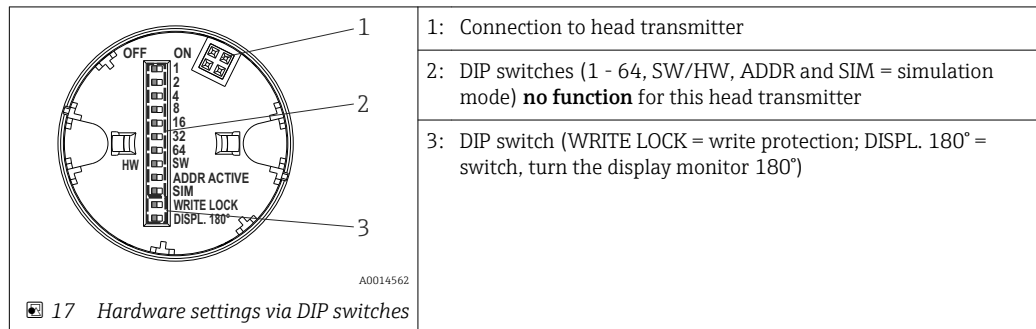

Procedure for setting the DIP switch:

1. Open the cover of the terminal head or field housing.
2. Remove the attached display from the head transmitter.
3. Configure the DIP switch on the rear of the display accordingly. In general: switch to ON = function enabled, switch to OFF = function disabled.
4. Fit the display onto the head transmitter in the correct position. The head transmitter accepts the settings within one second.
5. Secure the cover back onto the terminal head or field housing.

#### Switching write protection on/off

Write protection is switched on and off via a DIP switch on the rear of the optional attachable display. When write protection is active, parameters cannot be modified. A lock symbol on the display indicates that write protection is on. Write protection prevents any write access to the parameters. Write protection remains active even when the display is removed. To deactivate write protection, the display must be attached to the transmitter with the DIP switch switched off (WRITE LOCK = OFF). The transmitter adopts the setting during operation and does not need to be restarted.

#### Turning the display

The display can be rotated 180° using the "DISPL. 180°" DIP switch.



## 6.2 Structure and function of the operating menu

### 6.2.1 Structure of the operating menu

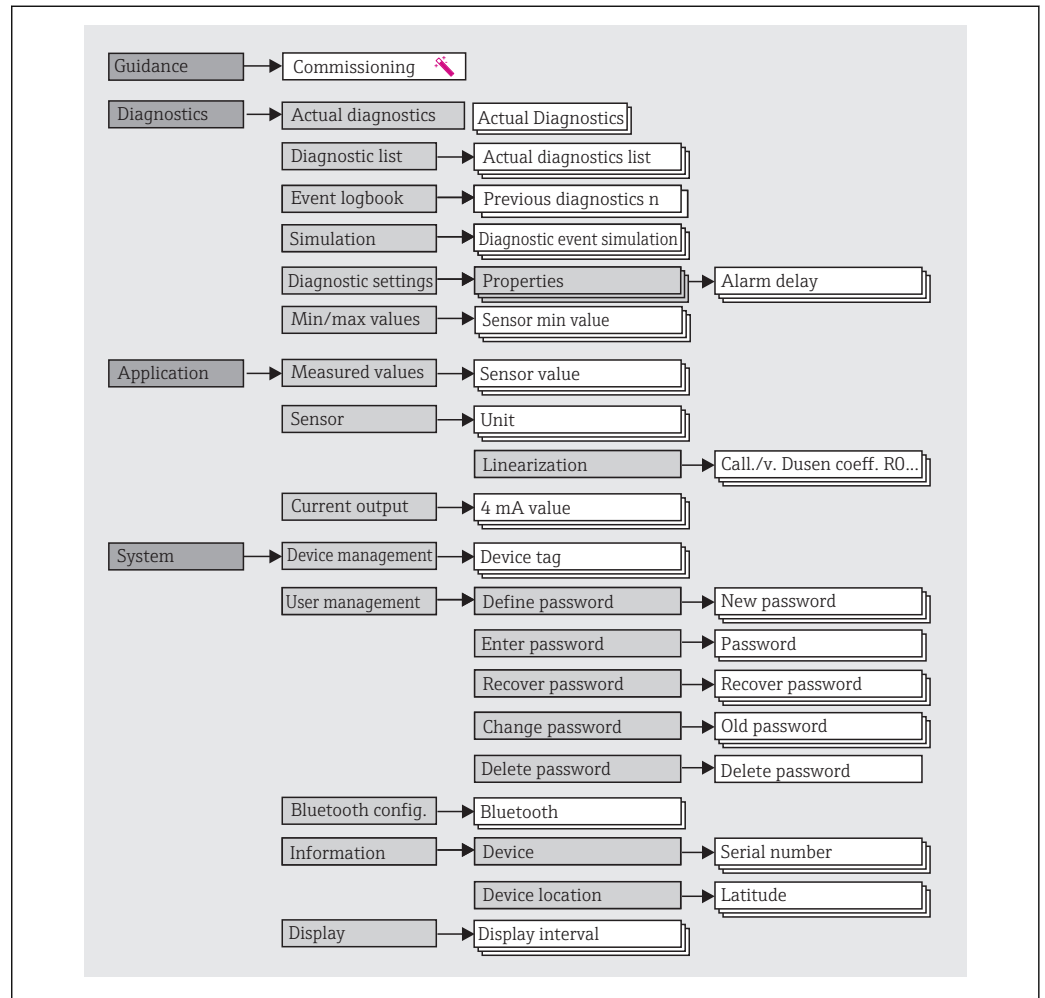

A0037913-EN

#### User roles

Endress+Hauser's role-based access concept consists of two hierarchical levels for the user and presents the various user roles with defined read/write authorizations derived from the NAMUR shell model.

- **Operator**

The plant operator can only change settings that do not affect the application - and particularly the measuring path - and simple, application-specific functions that are used during operation. The operator is able to read all the parameters, however.

- **Maintenance**

The **Maintenance** user role refers to configuration situations: commissioning and process adaptations as well as troubleshooting. It allows the user to configure and modify all available parameters. In contrast to the **Operator** user role, in the **Maintenance** role the user has read and write access to all the parameters.

- **Changing the user role**

A user role - and therefore existing read and write authorization - is changed by selecting the desired user role (already pre-selected depending on the operating tool) and entering the correct password when subsequently prompted. When a user logs out, system access always returns to the lowest level in the hierarchy. A user is logged out either by actively selecting the logout function when operating the device or is logged out automatically if the device is not operated for a period of over 600 seconds. Irrespective of this, actions that are already in progress (e.g. active upload/download, data logging, etc.) continue to be executed in the background.

- **As-delivered state**

The **Operator** user role is not enabled when the device is delivered from the factory, i.e. the **Maintenance** role is the lowest level in the hierarchy ex-works. This state makes it possible to commission the device and make other process adaptations without having to enter a password. Afterwards, a password can be assigned for the **Maintenance** user role to protect this configuration. The **Operator** user role is not visible when the device is delivered from the factory.

- **Password**

The **Maintenance** user role can assign a password in order to restrict access to device functions. This activates the **Operator** user role, which is now the lowest hierarchy level where the user is not asked to enter a password. The password can only be changed or disabled in the **Maintenance** user role. A password can be defined at different points in the operation of the device:

In the menu Guidance → Commissioning wizard: as part of guided device operation

In the menu: System → User management

## Submenus

Menu	Typical tasks	Content/meaning
"Diagnostics"	Troubleshooting: <ul style="list-style-type: none"> <li>▪ Diagnosing and eliminating process errors.</li> <li>▪ Error diagnostics in difficult cases.</li> <li>▪ Interpretation of device error messages and correcting associated errors.</li> </ul>	Contains all parameters for detecting and analyzing errors: <ul style="list-style-type: none"> <li>▪ <b>Diagnostic list</b> Contains up to 3 error messages currently pending</li> <li>▪ <b>Event logbook</b> Contains the last 10 error messages</li> <li>▪ <b>"Simulation" submenu</b> Used to simulate measured values, output values or diagnostic messages</li> <li>▪ <b>"Diagnostic settings" submenu</b> Contains all the parameters for configuring error events</li> <li>▪ <b>"Min/max values" submenu</b> Contains the minimum/maximum indicator and the reset option</li> </ul>
"Application"	Commissioning: <ul style="list-style-type: none"> <li>▪ Configuration of the measurement.</li> <li>▪ Configuration of data processing (scaling, linearization, etc.).</li> <li>▪ Configuration of the analog measured value output.</li> </ul> Tasks during operation: Reading measured values.	Contains all parameters for commissioning: <ul style="list-style-type: none"> <li>▪ <b>"Measured values" submenu</b> Contains all the current measured values</li> <li>▪ <b>"Sensor" submenu</b> Contains all the parameters for configuring the measurement</li> <li>▪ <b>"Output" submenu</b> Contains all the parameters for configuring the analog current output</li> </ul>
"System"	Tasks that require detailed knowledge of the system administration of the device: <ul style="list-style-type: none"> <li>▪ Optimum adaptation of the measurement for system integration.</li> <li>▪ Detailed configuration of the communication interface.</li> <li>▪ User and access administration, password control</li> <li>▪ Information concerning device identification, and display configuration</li> </ul>	Contains all the higher-level device parameters that are assigned for system, device and user management, including Bluetooth configuration. <ul style="list-style-type: none"> <li>▪ <b>"Device management" submenu</b> Contains parameters for general device management</li> <li>▪ <b>"Bluetooth configuration" submenu (option)</b> Contains the function for enabling/disabling the Bluetooth interface</li> <li>▪ <b>"Device and user management" submenus</b> Parameters for access authorization, password assignment, etc.</li> <li>▪ <b>"Information" submenu</b> Contains all the parameters for the unique identification of the device</li> <li>▪ <b>"Display" submenu</b> Configuration of the display</li> </ul>

## 6.3 Access to the operating menu via the operating tool

### 6.3.1 DeviceCare

#### Function scope

DeviceCare is a free configuration tool for Endress+Hauser devices. It supports devices with the following protocols, provided a suitable device driver (DTM) is installed: HART, PROFIBUS, FOUNDATION Fieldbus, Ethernet/IP, Modbus, CDI, ISS, IPC and PCP. The tool is aimed at customers without a digital network in plants and workshops and Endress +Hauser service technicians. The devices can be connected directly via a modem (point-to-point) or a bus system. DeviceCare is fast, easy and intuitive to use. It can run on a PC, laptop or tablet with a Windows operating system.

#### Source for device description files

See information →  31

### 6.3.2 FieldCare

#### Function scope

FDT/DTM-based plant asset management tool from Endress+Hauser. It can configure all smart field units in a system and help you manage them. By using the status information,

it is also a simple but effective way of checking their status and condition. Access is via the HART® protocol, CDI (= Endress+Hauser Common Data Interface). It also supports devices with the following protocols, provided a suitable device driver (DTM) is installed: PROFIBUS, FOUNDATION Fieldbus.

Typical functions:

- Configuring parameters of transmitters
- Loading and saving device data (upload/download)
- Documentation of the measuring point
- Visualization of the measured value memory (line recorder) and event logbook



For details, see Operating Instructions BA027S/04/xx and BA059AS/04/xx

### Source for device description files

See information →  31

### Establishing a connection

Example: CDI communication kit FXA291 (USB)

1. Make sure that the DTM library is updated for all the connected devices (e.g. FXA19x, TMTxy).
2. Start FieldCare and create a project.
3. Go to View --> Network: right-click **Host PC** Add device...
  - ↳ The **Add device** window opens.
4. Select the **CDI Communication FXA291** option from the list and press **OK** to confirm.
5. Double-click **CDI Communication FXA291** DTM instance.
  - ↳ Check whether the correct modem is connected to the serial interface and press **OK** to confirm.
6. Right-click **CDI Communication FXA291** and select the **Add device** option in the context menu that opens.
7. Select the desired device from the list and press **OK** to confirm.
  - ↳ The device now appears in the network list.
8. Right-click the device and select the **Connect** option in the context menu.
  - ↳ The CommDTM is displayed in green.
9. Double-click the device in the network to establish the online connection to the device.
  - ↳ The online configuration is available.



If transferring the device parameters following an offline configuration, the password for **Maintenance** - if assigned - must first be entered in the "User management" menu.

## User interface

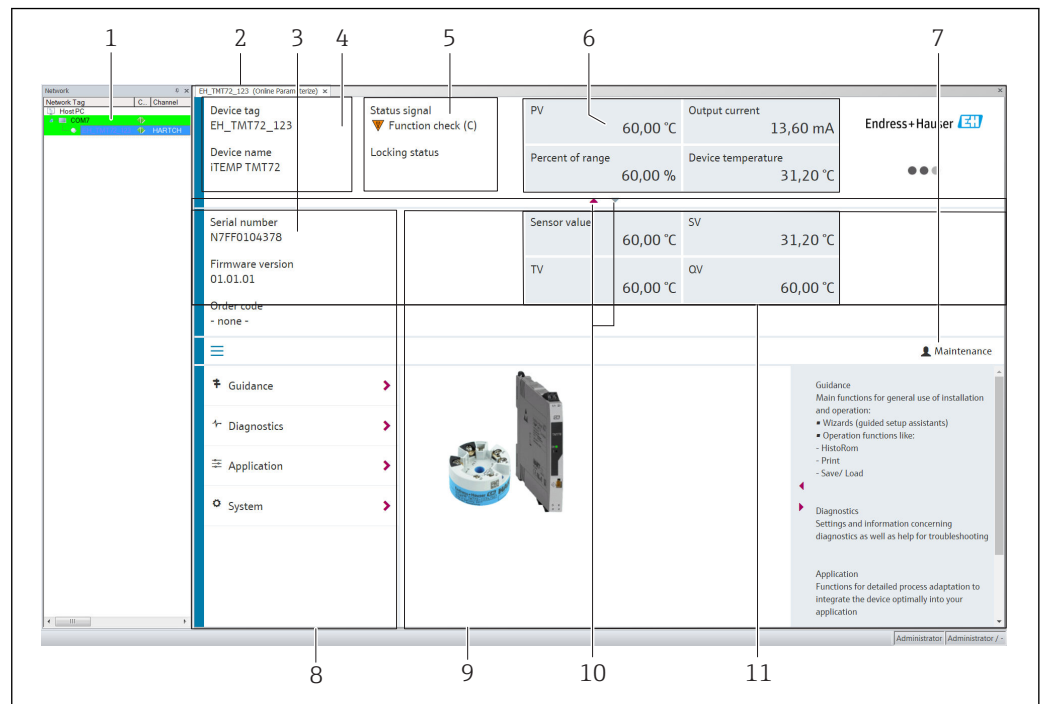

18 FieldCare user interface with device information

- 1 Network view
- 2 Header
- 3 Extended header
- 4 Tag name and device name
- 5 Status signal
- 6 Measured values with device and measured value status information, simple presentation, e.g. PV, output current, % span, device temperature
- 7 Current user role (with direct link to user management)
- 8 Navigation area with operating menu structure
- 9 Work area and help section that can be shown/hidden
- 10 Navigation arrow to show/hide the extended header
- 11 Extended display of device and measured value information, e.g. sensor value, SV (TV, QV)

## 6.4 Access to the operating menu via the SmartBlue app

The device can be operated and configured via the SmartBlue app. The connection is established via the Bluetooth® interface.

Prerequisite:

- The device has the optional Bluetooth interface: order code "Output signal; operation", option P: "4-20 mA; DTM/Bluetooth (app) configuration"
- A smartphone or tablet with the SmartBlue app installed.

Supported functions

- Device selection in Live List and access to the device (login)
- Configuration of the device
- Access to measured values, device status and diagnostics information

The SmartBlue app is available for free download for Android devices (Google Playstore) and iOS devices (iTunes Apple Shop) : *Endress+Hauser SmartBlue*

Directly to the app with the QR code:



A0037924

### System requirements

- Devices with iOS:
  - iPhone 4S or higher, from iOS9.0
  - iPad2 or higher, from iOS9.0
  - iPod Touch 5th generation or higher, from iOS9.0
- Devices with Android:
  - Android 4.4 KitKat or higher

Download the SmartBlue app:

1. Install and start the SmartBlue app.
  - ↳ A Live List shows all the devices available.
2. Select the device from the Live List.
  - ↳ The Login dialog box opens.

Logging in:

3. Enter the user name: **admin**
4. Enter the initial password: serial number of the device.
5. Confirm your entry.
  - ↳ The device information opens.

 Navigate through the various items of information about the device: swipe the screen to the side.



- The range under reference conditions is:
  - 10 m (33 ft) when installed in the terminal head or field housing with a display window or DIN rail transmitter
  - 5 m (16.4 ft) when installed in the terminal head or field housing
- Incorrect operation by unauthorized persons is prevented by means of encrypted communication and password encryption
- The Bluetooth® interface can be deactivated.

 The transmitter's optional Bluetooth interface is only active if a display unit is not attached or the CDI interface is not used for device configuration.

## 7 System integration

### 7.1 Overview of device description files

*Version data for the device*

Firmware version	01.01.zz	<ul style="list-style-type: none"> <li>▪ On the title page of the Operating instructions</li> <li>▪ On the nameplate →  1,  9</li> <li>▪ <b>Firmware version</b> parameter System → Information → Device → Firmware version</li> </ul>
------------------	----------	--

The suitable device driver software (DD/DTM) for the individual operating tools can be acquired from a variety of sources:

- [www.endress.com](http://www.endress.com) --> Downloads --> Search field: Software --> Software type: Device driver
- [www.endress.com](http://www.endress.com) --> Products: individual product page, e.g. TMTxy --> Documents/Manuals/Software: Electronic Data Description (EDD) or Device Type Manager (DTM).
- Via DVD (please contact your local Endress+Hauser Sales Center)

Endress+Hauser supports all common operating tools from a variety of manufacturers (e.g. Emerson Process Management, ABB, Siemens, Yokogawa, Honeywell and many others). Endress+Hauser's FieldCare and DeviceCare operating tools are available for download ([www.endress.com](http://www.endress.com) --> Downloads --> Search field: Software --> Application software) or on the optical data storage medium (DVD) which you can obtain from your local Endress+Hauser Sales Center.

### 7.2 Measured variables



The following measured values are assigned to the device variables at the factory:

Device variable	Measured value
Primary device variable (PV)	Sensor
Secondary device variable (SV)	Device temperature
Tertiary device variable (TV)	Sensor
Quaternary device variable (QV)	Sensor

## 8 Commissioning



### 8.1 Post-installation check

Before commissioning the measuring point make sure that all final checks have been carried out:

- "Post-installation check" checklist →  16
- "Post-connection check" checklist →  21

### 8.2 Switching on the transmitter

Once you have completed the post-connection checks, switch on the supply voltage. The transmitter performs a number of internal test functions after power-up. During this process, the following sequence of messages appears on the display:

Step	Display
1	"Display" text and firmware version of the display
2	Device name with firmware version, hardware version and device revision
3	Displays the sensor configuration (sensor type and type of connection) along with the configured measuring range
4a	Current measured value or
4b	Current status message   If the switch-on procedure is not successful, the relevant diagnostic event, depending on the cause, is displayed. A detailed list of diagnostic events and the corresponding troubleshooting instructions can be found in the "Diagnostics and troubleshooting" section →  36.

The device operates in normal mode after approx. 7 seconds, including the attached display. Normal measuring mode commences as soon as the switch-on procedure is completed. Measured values and status values appear on the display.

-  If the display is attached when the Bluetooth interface is activated, display initialization is performed twice and Bluetooth communication is disabled simultaneously.

### 8.3 Configuring the measuring device

#### Wizards

The **Guidance** menu contains various wizards. Wizards not only query individual parameters but also guide the user through the configuration and/or verification of entire sets of parameters with step-by-step instructions, including questions, that are comprehensible for the user. The "Start" button can be disabled for wizards that require specific access authorization (keyhole symbol appears on the screen).





The following five operating elements are supported for navigation in the wizards:

- **Start**  
Only on the initial page: start the wizard and go to the first section
- **Next**  
Go to the next page of the wizard. Is not enabled until parameters are entered or confirmed.
- **Back**  
Return to the previous page
- **Cancel**  
If Cancel is selected, the status before the wizard was started is restored
- **Finish**  
Closes the wizard and possibility of making additional parameter settings on the device. Only enabled on the final page.

### 8.3.1 Commissioning wizard

Commissioning is the first step towards using the device for the designated application. The Commissioning wizard contains an introductory page (with the "Start" operating element) and a short description of the content. The wizard consists of several sections in which the user is guided step-by-step through the commissioning of the device.

"Device management" is the first section that appears when the user runs the wizard, and contains the following parameters. Its main purpose is to provide information about the device:

**Navigation**  **Guidance → Commissioning → Start** 





A0037378-EN

Device TAG  
Device name  
Serial number  
Extended order code (n) <sup>1)</sup>

1) n = placeholder for 1, 2, 3

The second section, "Sensor", takes the user through all the relevant settings for the sensor. The number of parameters displayed depends on the corresponding settings. The following parameters can be configured:

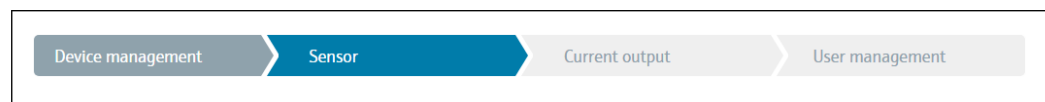

**Navigation**  **Guidance → Commissioning → Sensor** 



A0037389-EN

Unit  
Sensor type  
Connection type  
2-wire compensation  
Reference junction  
RJ preset value

In the third section, the settings are made for the analog output and the output's alarm response. The following parameters can be configured:



**Navigation**  **Guidance → Commissioning → Current output** 



A0037390-EN

4 mA value  
20 mA value  
Failure mode  
Failure current

In the final section, a password can be defined for the "Maintenance" user role. This is strongly recommended to protect the device against unauthorized access. The following steps describe how to configure a password for the "Maintenance" role for the first time.

**Navigation**  **Guidance → Commissioning → User management** 



A0037391-EN

Access status  
New password  
Confirm new password

1. The **Maintenance** role appears in the "Access status" picklist. The **Maintenance** user role must first be selected when operating with the SmartBlue App.
  - ↳ Afterwards, the **New password** and **Confirm new password** input boxes appear.
2. Enter a user-defined password that meets the password rules indicated in the online help.
3. Enter the password again in the **Confirm new password** input box.

Once the password has been entered successfully, parameter changes, particularly those that are needed for commissioning, process adaptation/optimization and troubleshooting, can only be implemented in the **Maintenance** user role and if the password is entered successfully.

## 8.4 Protecting settings from unauthorized access

### 8.4.1 Hardware locking

The device can be protected against unauthorized access by hardware locking. In the locking and access concept, hardware locking always has top priority. The device is write-protected if the keyhole symbol appears in the header of the measured value display. To disable write protection, switch the write protection switch on the back of the display to the "OFF" position (hardware write protection). →  23

### 8.4.2 Software locking

By assigning a password for the **Maintenance** user role, it is possible to restrict access authorization and protect the device against unauthorized access.

 See the Commissioning wizard →  33

The parameters are also protected against modification by logging out of the **Maintenance** user role and switching to the **Operator** role. No keyhole symbol is displayed, however.



To disable the write protection, the user must log on with the **Maintenance** user role via the relevant operating tool.

 User role concept →  25

## 9 Diagnostics and troubleshooting

### 9.1 General troubleshooting

Always start troubleshooting with the checklists below if faults occur after startup or during operation. The checklists take you directly (via various queries) to the cause of the problem and the appropriate remedial measures.

 Due to its design, the device cannot be repaired. However, it is possible to send the device in for examination. See the information in the "Return" section. →  42

#### General errors

Problem	Possible cause	Remedy
Device is not responding.	Supply voltage does not match that specified on the nameplate.	Check the voltage at the transmitter directly using a voltmeter and correct.
	Connecting cables are not in contact with the terminals.	Check the contacting of the cables and correct if necessary.
	Electronics unit is defective.	Replace the device.
Output current < 3.6 mA	Signal line is not wired correctly.	Check wiring.
	Electronics unit is defective.	Replace the device.



#### Check display (optionally in conjunction with head transmitter)

Problem	Possible cause	Remedy
No display visible	No supply voltage	<ul style="list-style-type: none"> <li>▪ Check the supply voltage at the head transmitter, terminals + and -.</li> <li>▪ Ensure that the display module holders are correctly seated and that the display module is properly connected to the head transmitter →  11.</li> <li>▪ If possible, test the display module with other suitable head transmitters, e.g. an Endress+Hauser head transmitter.</li> </ul>
	The display module is defective.	Replace the module.
	The electronics of the head transmitter are defective.	Replace the head transmitter.



Local error messages on the display
→  38



Error messages in the configuration software
→  38

*Application errors without status messages for RTD sensor connection*

Problem	Possible cause	Remedy
Measured value is incorrect/ inaccurate	Incorrect sensor orientation.	Install the sensor correctly.
	Heat conducted by sensor.	Observe the face-to-face length of the sensor.
	Device programming is incorrect (number of wires).	Change the <b>Connection type</b> device function.
	Device programming is incorrect (scaling).	Change scaling.
	Incorrect RTD configured.	Change the <b>Sensor type</b> device function.
	Sensor connection.	Check that the sensor is connected correctly.
	The cable resistance of the sensor (2-wire) was not compensated.	Compensate the cable resistance.
	Offset incorrectly set.	Check offset.
Failure current ( $\leq 3.6$ mA or $\geq 21$ mA)	Faulty sensor.	Check the sensor.
	RTD connected incorrectly.	Install the connecting cables correctly (terminal diagram).
	Device programming is incorrect (e.g. number of wires).	Change the <b>Connection type</b> device function.
	Incorrect programming.	Incorrect sensor type set in the <b>Sensor type</b> device function. Set the correct sensor type.

*Application errors without status messages for TC sensor connection*

Problem	Possible cause	Remedy
Measured value is incorrect/ inaccurate	Incorrect sensor orientation.	Install the sensor correctly.
	Heat conducted by sensor.	Observe the face-to-face length of the sensor.
	Device programming is incorrect (scaling).	Change scaling.
	Incorrect thermocouple type (TC) configured.	Change the <b>Sensor type</b> device function.
	Incorrect reference measuring point set.	Set the correct reference measuring point.
	Interference via the thermocouple wire welded in the thermowell (interference voltage coupling).	Use a sensor where the thermocouple wire is not welded.
	Offset incorrectly set.	Check offset.
Failure current ( $\leq 3.6$ mA or $\geq 21$ mA)	Faulty sensor.	Check the sensor.
	Sensor is connected incorrectly.	Install the connecting cables correctly (terminal diagram).
	Incorrect programming.	Incorrect sensor type set in the <b>Sensor type</b> device function. Set the correct sensor type.

## 9.2 Diagnostic information on local display

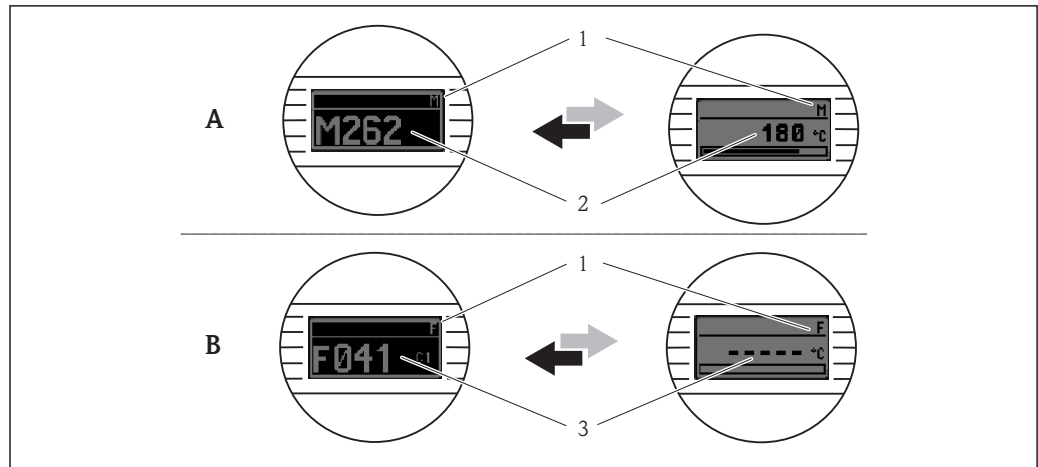

A0014837

- A Display in the event of a warning
- B Display in the event of an alarm
- 1 Status signal in the header
- 2 The display alternates between the primary measured value and the status - indicated by the appropriate letter (M, C or S) - plus the defined error number.
- 3 The display alternates between "- - -" (no valid measured value) and the status - indicated by the appropriate letter (F) - plus the defined error number.

## 9.3 Diagnostic information via communication interface

### NOTICE

Status signals and diagnostic behavior can be configured manually for certain diagnostic events. If a diagnostic event occurs, however, it is not guaranteed that the measured values are valid for the event and comply with the process for the status signals S and M and the diagnostic behavior: 'Warning' and Disabled'.

- Reset the status signal assignment to the factory setting.

### Status signals

Letter/symbol <sup>1)</sup>	Event category	Meaning
F	Operating error	An operating error has occurred.
C	Service mode	The device is in service mode (e.g. during a simulation).
S	Out of specification	The device is being operated outside its technical specifications (e.g. during warm-up or cleaning processes).
M	Maintenance required	Maintenance is required.
N -	Not categorized	

1) As per NAMUR NE107



### Diagnostic behavior

<b>Alarm</b>	Measurement is interrupted. The signal outputs assume the defined alarm condition. A diagnostic message is generated.
<b>Warning</b>	The device continues to measure. A diagnostic message is generated.
<b>Disabled</b>	The diagnosis is completely disabled even if the device is not recording a measured value.

## 9.4 Diagnostic list

If two or more diagnostics events are pending simultaneously, only the message with the highest priority is shown. Additional pending diagnostic messages are shown in the **Diagnostic list** submenu. The status signal dictates the priority in which the diagnostic messages are displayed. The following order of priority applies: F, C, S, M. If two or more diagnostic events with the same status signal are active simultaneously, the numerical order of the event number dictates the order of priority in which the events are displayed, e.g.: F042 appears before F044 and before S044.

## 9.5 Event logbook

 Previous diagnostic messages are displayed in the **Event logbook** submenu.  
→  65

## 9.6 Overview of diagnostic events

Each diagnostic event is assigned a certain event behavior at the factory. The user can change this assignment for certain diagnostic events.







Example:







































Configuration examples	Diagnostic number	Settings		Device behavior			
		Status signal	Diagnostic behavior from the factory	Status signal (output via communication)	Current output	PV, status	Display
1. Default setting	047	S	Warning	S	Measured value	Measured value, UNCERTAIN	S047
2. Manual setting: status signal S changed to F	047	F	Warning	F	Measured value	Measured value, UNCERTAIN	F047
3. Manual setting: <b>Warning</b> diagnostic behavior changed to <b>Alarm</b>	047	S	Alarm	S	Configured failure current	Measured value, BAD	S047
4. Manual setting: <b>Warning</b> changed to <b>Disabled</b>	047	S <sup>1)</sup>	Disabled	- <sup>2)</sup>	Last valid measured value <sup>3)</sup>	Last valid measured value, GOOD	S047

1) Setting is not relevant.

2) Status signal is not displayed.

3) The failure current is output if no valid measured value is available.

Diagnostic number	Short text	Corrective measure	Status signal from the factory		Diagnostic behavior from the factory	
				Customizable <sup>1)</sup>		Not customizable
<b>Diagnostics for the sensor</b>						
041	Sensor interrupted	1. Check electrical wiring. 2. Replace sensor. 3. Check connection type.	F		Alarm	
042	Sensor corroded	1. Check sensor. 2. Replace sensor.	M		Warning	

Diagnostic number	Short text	Corrective measure	Status signal from the factory		Diagnostic behavior from the factory	
				Customizable <sup>1)</sup>		Customizable <sup>2)</sup>
						
				Not customizable		Not customizable
043	Short-circuit	1. Check electrical connection. 2. Check sensor. 3. Replace sensor or cable.	F		Alarm	
047	Sensor limit reached sensor n	1. Check sensor. 2. Check process conditions.	S		Warning	
145	Compensation reference point	1. Check terminal temperature. 2. Check external reference point.	F		Alarm	
<b>Diagnostics for the electronics</b>						
201	Electronics faulty	1. Restart device. 2. Replace electronics.	F		Alarm	
221	Reference sensor defective	Replace device.	M		Alarm	
<b>Diagnostics for the configuration</b>						
401	Factory reset active	Factory reset active, please wait.	C		Warning	
402	Initialization active	Initialization active, please wait.	C		Warning	
410	Data transfer failed	1. Check connection. 2. Retry data transfer.	F		Alarm	
411	Up-/download active	Up-/download active, please wait.	C		Warning	
435	Linearization faulty	Check linearization.	F		Alarm	
485	Process variable simulation active	Deactivate simulation.	C		Warning	
491	Current output simulation	Deactivate simulation.	C		Warning	
495	Diagnostic event simulation active	Deactivate simulation.	C		Warning	
531	Factory adjustment missing	1. Contact service. 2. Replace device.	F		Alarm	
537	Configuration	1. Check device configuration 2. Upload and download new configuration. (In case of current output: check configuration of analog output.)	F		Alarm	
582	Sensor diagnostics TC deactivated	Switch on diagnostics for thermocouple measurement	C		Warning	
<b>Diagnostics for the process</b>						
801	Supply voltage too low <sup>3)</sup>	Increase supply voltage.	S		Alarm	



Diagnostic number	Short text	Corrective measure	Status signal from the factory	✓ Customizable <sup>1)</sup>	Diagnostic behavior from the factory	✓ Customizable <sup>2)</sup>
				✗ Not customizable		✗ Not customizable
825	Operating temperature	1. Check ambient temperature. 2. Check process temperature.	S	✓	Warning	✓
844	Process value outside specification	1. Check process value. 2. Check application. Check sensor.	S	✓	Warning	✓

1) Can be set to F, C, S, M, N

2) Can be set to 'Alarm', 'Warning' and 'Disabled'

3) In the case of this diagnostic event, the device always outputs a "low" alarm status (output current  $\leq 3.6$  mA).

## 9.7 Firmware history

### Revision history

The firmware version (FW) on the nameplate and in the Operating Instructions indicates the device release: XX.YY.ZZ (example 01.02.01).

XX Change to main version. No longer compatible. The device and Operating Instructions change.

YY Change to functions and operation. Compatible. The Operating Instructions change.

ZZ Fixes and internal changes. No changes to the Operating Instructions.

Date	Firmware version	Changes	Documentation
11/2018	01.01.zz	Original firmware	BA01927T/09/en/01.18

## 10 Maintenance

No special maintenance work is required for the device.

### Cleaning

A clean, dry cloth can be used to clean the device.

## 11 Repair

### 11.1 General information

The version of the device is such that it cannot be repaired.

## 11.2 Spare parts

Spare parts currently available for the device can be found online at: [http://www.products.endress.com/spareparts\\_consumables](http://www.products.endress.com/spareparts_consumables). Always quote the serial number of the device when ordering spare parts!

Type	Order number
Standard - DIN securing set (2 screws and springs, 4 shaft lock-down rings, 1 plug for the display interface)	71044061
US - M4 securing set (2 screws and 1 plug for the display interface)	71044062

## 11.3 Return

The requirements for safe device return can vary depending on the device type and national legislation.

1. Refer to the website for more information: <http://www.endress.com/support/return-material>
2. Return the device if repairs or a factory calibration are required, or if the wrong device was ordered or delivered.

## 11.4 Disposal



If required by the Directive 2012/19/EU on waste electrical and electronic equipment (WEEE), our products are marked with the depicted symbol in order to minimize the disposal of WEEE as unsorted municipal waste. Such products may not be disposed of as unsorted municipal waste and can be returned to Endress+Hauser for disposal at conditions stipulated in our General Terms and Conditions or as individually agreed.

# 12 Accessories

Various accessories, which can be ordered with the device or subsequently from Endress+Hauser, are available for the device. Detailed information on the order code in question is available from your local Endress+Hauser sales center or on the product page of the Endress+Hauser website: [www.endress.com](http://www.endress.com).

Accessories included in the scope of delivery:

- Multilingual Brief Operating Instructions as hard copy
- ATEX supplementary documentation: ATEX Safety instructions (XA), Control Drawings (CD)
- Mounting material for head transmitter



## 12.1 Device-specific accessories

Accessories
TID10 display unit for Endress+Hauser head transmitter iTEMP TMT8x <sup>1)</sup> or TMT7x, attachable
TID10 service cable; connecting cable for service interface, 40 cm
Field housing TA30x for Endress+Hauser head transmitter
Adapter for DIN rail mounting, clip as per IEC 60715 (TH35) without securing screws

Accessories
Standard - DIN mounting set (2 screws + springs, 4 securing disks and 1 display connector cover)
US - M4 Mounting screws (2 M4 screws and 1 display connector cover)
Stainless steel wall mounting bracket Stainless steel pipe mounting bracket



1) Without TMT80

## 12.2 Communication-specific accessories



Accessories	Description
Commubox FXA291	Connects Endress+Hauser field devices with a CDI interface (= Endress+Hauser Common Data Interface) and the USB port of a computer or laptop.  For details, see Technical Information TI405C/07
Field Xpert SMT70	Universal, high-performance tablet PC for device configuration The tablet PC enables mobile plant asset management in hazardous and non-hazardous areas. It is suitable for commissioning and maintenance staff to manage field instruments with a digital communication interface and to record progress. This tablet PC is designed as a comprehensive, all-in-one solution. With a pre-installed driver library, it is an easy-to-use, touch-sensitive tool which can be used to manage field instruments throughout their entire life cycle.  For details, see Technical Information TI01342S/04
Configuration kit TXU10	Configuration kit for PC-programmable transmitter - FDT/DTM-based plant asset management tool, FieldCare/DeviceCare, and interface cable (4-pin connector) for PC with USB port.

## 12.3 Service-specific accessories

Accessories	Description
Applicator	Software for selecting and sizing Endress+Hauser measuring devices: <ul style="list-style-type: none"> <li>Calculation of all the necessary data for identifying the optimum measuring device: e.g. pressure loss, accuracy or process connections.</li> <li>Graphic illustration of the calculation results</li> </ul> Administration, documentation and access to all project-related data and parameters over the entire life cycle of a project. Applicator is available: Via the Internet: <a href="https://portal.endress.com/webapp/applicator">https://portal.endress.com/webapp/applicator</a>
Configurator	Product Configurator - the tool for individual product configuration <ul style="list-style-type: none"> <li>Up-to-the-minute configuration data</li> <li>Depending on the device: Direct input of measuring point-specific information such as measuring range or operating language</li> <li>Automatic verification of exclusion criteria</li> <li>Automatic creation of the order code and its breakdown in PDF or Excel output format</li> <li>Ability to order directly in the Endress+Hauser Online Shop</li> </ul> The Configurator is available on the Endress+Hauser website: <a href="http://www.endress.com">www.endress.com</a> -> Click "Corporate" -> Select your country -> Click "Products" -> Select the product using the filters and the search field -> Open the product page -> The "Configure" button to the right of the product image opens the Product Configurator.

DeviceCare SFE100	<p>Configuration tool for devices via fieldbus protocols and Endress+Hauser service protocols.</p> <p>DeviceCare is the tool developed by Endress+Hauser for the configuration of Endress+Hauser devices. All smart devices in a plant can be configured via a point-to-point or point-to-bus connection. The user-friendly menus enable transparent and intuitive access to the field devices.</p> <p> For details, see Operating Instructions BA00027S</p>
FieldCare SFE500	<p>FDT-based plant asset management tool from Endress+Hauser.</p> <p>It can configure all smart field units in your system and helps you manage them. By using the status information, it is also a simple but effective way of checking their status and condition.</p> <p> For details, see Operating Instructions BA00027S and BA00065S</p>
W@M	<p>Life cycle management for your plant</p> <p>W@M supports you with a wide range of software applications over the entire process: from planning and procurement, to the installation, commissioning and operation of the measuring devices. All the relevant device information, such as the device status, spare parts and device-specific documentation, is available for every device over the entire life cycle.</p> <p>The application already contains the data of your Endress+Hauser device. Endress+Hauser also takes care of maintaining and updating the data records.</p> <p>W@M is available: Via the Internet: <a href="http://www.endress.com/lifecyclemanagement">www.endress.com/lifecyclemanagement</a></p>

## 12.4 System components

Accessories	Description
RN221N	<p>Active barrier with power supply for safe separation of 4 to 20 mA standard signal circuits. Has bidirectional HART® transmission and optional HART® diagnostics if transmitters are connected with monitoring of 4 to 20 mA signal or HART® status byte analysis and an E+H-specific diagnostic command.</p> <p> For details, see Technical Information TI073R/09</p>
RIA15	<p>Process display, digital loop-powered display for 4 to 20 mA circuit, panel mounting, with optional HART® communication. Displays 4 to 20 mA or up to 4 HART® process variables</p> <p> For details, see Technical Information TI01043K/09</p>
Graphic Data Manager Memograph M	<p>The Advanced Data Manager Memograph M is a flexible and powerful system for organizing process values. Optional HART® input cards are available, each with 4 inputs (4/8/12/16/20), with highly accurate process values from the HART® devices directly connected for the purpose of calculation and data logging. The measured process values are clearly presented on the display and logged safely, monitored for limit values and analyzed. Via common communication protocols, the measured and calculated values can be easily communicated to higher-level systems or individual plant modules can be interconnected.</p> <p> For details, see Technical Information TI01180R/09</p>

## 13 Technical data

### 13.1 Input

Measured variable                      Temperature (temperature-linear transmission behavior), resistance and voltage.

Resistance thermometer (RTD) as per standard	Designation	$\alpha$	Measuring range limits	Min. span
IEC 60751:2008	Pt100 (1) Pt200 (2) Pt500 (3) Pt1000 (4)	0.003851	-200 to +850 °C (-328 to +1562 °F) -200 to +850 °C (-328 to +1562 °F) -200 to +500 °C (-328 to +932 °F) -200 to +250 °C (-328 to +482 °F)	10 K (18 °F)
JIS C1604:1984	Pt100 (5)	0.003916	-200 to +510 °C (-328 to +950 °F)	10 K (18 °F)
DIN 43760 IPTS-68	Ni100 (6) Ni120 (7)	0.006180	-60 to +250 °C (-76 to +482 °F) -60 to +250 °C (-76 to +482 °F)	10 K (18 °F)
GOST 6651-94	Pt50 (8) Pt100 (9)	0.003910	-185 to +1100 °C (-301 to +2012 °F) -200 to +850 °C (-328 to +1562 °F)	10 K (18 °F)
OIML R84: 2003, GOST 6651-2009	Cu50 (10) Cu100 (11)	0.004280	-180 to +200 °C (-292 to +392 °F) -180 to +200 °C (-292 to +392 °F)	10 K (18 °F)
	Ni100 (12) Ni120 (13)	0.006170	-60 to +180 °C (-76 to +356 °F) -60 to +180 °C (-76 to +356 °F)	10 K (18 °F)
OIML R84: 2003, GOST 6651-94	Cu50 (14)	0.004260	-50 to +200 °C (-58 to +392 °F)	10 K (18 °F)
-	Pt100 (Callendar van Dusen) Nickel polynomial Copper polynomial	-	The measuring range limits are specified by entering the limit values that depend on the coefficients A to C and R0.	10 K (18 °F)
	<ul style="list-style-type: none"> <li>▪ Type of connection: 2-wire, 3-wire or 4-wire connection, sensor current: <math>\leq 0.3</math> mA</li> <li>▪ With 2-wire circuit, compensation of wire resistance possible (0 to 30 <math>\Omega</math>)</li> <li>▪ With 3-wire and 4-wire connection, sensor wire resistance up to max. 50 <math>\Omega</math> per wire</li> </ul>			
<b>Resistance transmitter</b>	Resistance $\Omega$		10 to 400 $\Omega$ 10 to 2 000 $\Omega$	10 $\Omega$ 10 $\Omega$

Thermocouples as per standard	Designation	Measuring range limits		Min. span
IEC 60584, Part 1	Type A (W5Re-W20Re) (30)	0 to +2 500 °C (+32 to +4 532 °F)	Recommended temperature range: 0 to +2 500 °C (+32 to +4 532 °F)	50 K (90 °F)
	Type B (PtRh30-PtRh6) (31)	+40 to +1 820 °C (+104 to +3 308 °F)	+500 to +1 820 °C (+932 to +3 308 °F)	50 K (90 °F)
	Type E (NiCr-CuNi) (34)	-250 to +1 000 °C (-482 to +1 832 °F)	-150 to +1 000 °C (-238 to +1 832 °F)	50 K (90 °F)
	Type J (Fe-CuNi) (35)	-210 to +1 200 °C (-346 to +2 192 °F)	-150 to +1 200 °C (-238 to +2 192 °F)	50 K (90 °F)
	Type K (NiCr-Ni) (36)	-270 to +1 372 °C (-454 to +2 501 °F)	-150 to +1 200 °C (-238 to +2 192 °F)	50 K (90 °F)
	Type N (NiCrSi-NiSi) (37)	-270 to +1 300 °C (-454 to +2 372 °F)	-150 to +1 300 °C (-238 to +2 372 °F)	50 K (90 °F)
	Type R (PtRh13-Pt) (38)	-50 to +1 768 °C (-58 to +3 214 °F)	+50 to +1 768 °C (+122 to +3 214 °F)	50 K (90 °F)
	Type S (PtRh10-Pt) (39)	-50 to +1 768 °C (-58 to +3 214 °F)	+50 to +1 768 °C (+122 to +3 214 °F)	50 K (90 °F)
Type T (Cu-CuNi) (40)	-200 to +400 °C (-328 to +752 °F)	-150 to +400 °C (-238 to +752 °F)	50 K (90 °F)	
IEC 60584, Part 1; ASTM E988-96	Type C (W5Re-W26Re) (32)	0 to +2 315 °C (+32 to +4 199 °F)	0 to +2 000 °C (+32 to +3 632 °F)	50 K (90 °F)
ASTM E988-96	Type D (W3Re-W25Re) (33)	0 to +2 315 °C (+32 to +4 199 °F)	0 to +2 000 °C (+32 to +3 632 °F)	50 K (90 °F)
DIN 43710	Type L (Fe-CuNi) (41)	-200 to +900 °C (-328 to +1 652 °F)	-150 to +900 °C (-238 to +1 652 °F)	50 K (90 °F)
	Type U (Cu-CuNi) (42)	-200 to +600 °C (-328 to +1 112 °F)	-150 to +600 °C (-238 to +1 112 °F)	50 K (90 °F)
GOST R8.8585-2001	Type L (NiCr-CuNi) (43)	-200 to +800 °C (-328 to +1 472 °F)	-200 to +800 °C (+328 to +1 472 °F)	50 K (90 °F)

Thermocouples as per standard	Designation	Measuring range limits	Min. span
	<ul style="list-style-type: none"> <li>▪ Internal cold junction (Pt100)</li> <li>▪ External preset value: configurable value -40 to +85 °C (-40 to +185 °F)</li> <li>▪ Maximum sensor wire resistance 10 kΩ (If the sensor wire resistance is greater than 10 kΩ, an error message is output in accordance with NAMUR NE89.)</li> </ul>		
Voltage transmitter (mV)	Millivolt transmitter (mV)	-20 to 100 mV	5 mV

## 13.2 Output

Output signal	Analog output	4 to 20 mA, 20 to 4 mA (can be inverted)
	Galvanic isolation	U = 2 kV AC (input/output)

### Failure information

#### Failure information as per NAMUR NE43:

Failure information is created if the measuring information is missing or not valid. A complete list of all the errors occurring in the measuring system is created.

Underranging	Linear drop from 4.0 to 3.8 mA
Overranging	Linear increase from 20.0 to 20.5 mA
Failure e.g. sensor failure; sensor short-circuit	≤ 3.6 mA ("low") or ≥ 21 mA ("high"), can be selected The "high" alarm setting can be set between 21.5 mA and 23 mA, thus providing the flexibility needed to meet the requirements of various control systems.

### Linearization/transmission behavior

Temperature-linear, resistance-linear, voltage-linear

### Network frequency filter

50/60 Hz

### Filter

1st order digital filter: 0 to 120 s

### Protocol-specific data

Device description files DTM	Information and files under: <a href="http://www.endress.com">www.endress.com</a>
------------------------------	--

### Write protection for device parameters

- Hardware: Write protection for head transmitter on optional display using DIP switch
- Software: User role concept (password definition)

### Switch-on delay

≤ 7 s until the first valid measured value signal is present at the current output . While switch-on delay =  $I_a \leq 3.8 \text{ mA}$

## 13.3 Power supply

### Supply voltage

Values for non-hazardous areas, protected against polarity reversal:

- Head transmitter:  $10 \text{ V} \leq V_{cc} \leq 36 \text{ V}$
- DIN rail device:  $11 \text{ V} \leq V_{cc} \leq 36 \text{ V}$

Values for hazardous areas, see Ex documentation .

Current consumption	<ul style="list-style-type: none"> <li>■ 3.6 to 23 mA</li> <li>■ Minimum current consumption 3.5 mA</li> <li>■ Current limit <math>\leq 23</math> mA</li> </ul>
---------------------	---

Terminals Choice of screw or push-in terminals for sensor and supply cables:

Terminal version	Cable version	Cable cross-section
Screw terminals	Rigid or flexible	$\leq 2.5$ mm <sup>2</sup> (14 AWG)
Push-in terminals (cable version, stripping length = min. 10 mm (0.39 in))	Rigid or flexible	0.2 to 1.5 mm <sup>2</sup> (24 to 16 AWG)
	Flexible with wire end ferrules with/without plastic ferrule	0.25 to 1.5 mm <sup>2</sup> (24 to 16 AWG)

## 13.4 Performance characteristics

Response time	Resistance thermometer (RTD) and resistance transmitter ( $\Omega$ measurement)	$\leq 1$ s
	Thermocouples (TC) and voltage transmitters (mV)	$\leq 1$ s
	Reference temperature	$\leq 1$ s

 When recording step responses, it must be taken into account that the times the internal reference measuring point are added to the specified times where applicable.

Reference operating conditions	<ul style="list-style-type: none"> <li>■ Calibration temperature: <math>+25</math> °C <math>\pm 3</math> K (<math>77</math> °F <math>\pm 5.4</math> °F)</li> <li>■ Supply voltage: 24 V DC</li> <li>■ 4-wire circuit for resistance adjustment</li> </ul>
--------------------------------	---

Maximum measured error In accordance with DIN EN 60770 and the reference conditions specified above. The measured error data correspond to  $\pm 2 \sigma$  (Gaussian distribution). The data include non-linearities and repeatability.

MV = Measured value

LRV = Lower range value of relevant sensor

### Typical

Standard	Designation	Measuring range	Typical measured error ( $\pm$ )
<b>Resistance thermometer (RTD) as per standard</b>			Value at current output
IEC 60751:2008	Pt100 (1)	0 to $+200$ °C (32 to $+392$ °F)	0.10 °C (0.18 °F)
IEC 60751:2008	Pt1000 (4)		0.08 °C (0.14 °F)
GOST 6651-94	Pt100 (9)		0.09 °C (0.16 °F)
<b>Thermocouples (TC) as per standard</b>			Value at current output
IEC 60584, Part 1	Type K (NiCr-Ni) (36)	0 to $+800$ °C (32 to $+1472$ °F)	0.64 °C (1.15 °F)
IEC 60584, Part 1	Type S (PtRh10-Pt) (39)		1.84 °C (3.31 °F)
GOST R8.8585-2001	Type L (NiCr-CuNi) (43)		2.46 °C (4.43 °F)

Measured error for resistance thermometers (RTD) and resistance transmitters

Standard	Designation	Measuring range	Measured error (±)	
			Maximum <sup>1)</sup>	Based on measured value <sup>2)</sup>
IEC 60751:2008	Pt100 (1)	-200 to +850 °C (-328 to +1 562 °F)	≤ 0.33 °C (0.59 °F)	$ME = \pm \sqrt{((0.05 \text{ °C } (0.09 \text{ °F}) + 0.006\% * (MV - LRV))^2 + (0.03\% * MR)^2)}$
	Pt200 (2)		≤ 0.37 °C (0.67 °F)	$ME = \pm \sqrt{((0.08 \text{ °C } (0.14 \text{ °F}) + 0.011\% * (MV - LRV))^2 + (0.03\% * MR)^2)}$
	Pt500 (3)	-200 to +510 °C (-328 to +950 °F)	≤ 0.23 °C (0.41 °F)	$ME = \pm \sqrt{((0.035 \text{ °C } (0.063 \text{ °F}) + 0.008\% * (MV - LRV))^2 + (0.03\% * MR)^2)}$
	Pt1000 (4)	-200 to +250 °C (-328 to +482 °F)	≤ 0.15 °C (0.27 °F)	$ME = \pm \sqrt{((0.02 \text{ °C } (0.04 \text{ °F}) + 0.007\% * (MV - LRV))^2 + (0.03\% * MR)^2)}$
JIS C1604:1984	Pt100 (5)	-200 to +510 °C (-328 to +950 °F)	≤ 0.23 °C (0.41 °F)	$ME = \pm \sqrt{((0.045 \text{ °C } (0.08 \text{ °F}) + 0.006\% * (MV - LRV))^2 + (0.03\% * MR)^2)}$
GOST 6651-94	Pt50 (8)	-185 to +1 100 °C (-301 to +2 012 °F)	≤ 0.43 °C (0.77 °F)	$ME = \pm \sqrt{((0.08 \text{ °C } (0.14 \text{ °F}) + 0.008\% * (MV - LRV))^2 + (0.03\% * MR)^2)}$
	Pt100 (9)	-200 to +850 °C (-328 to +1 562 °F)	≤ 0.33 °C (0.59 °F)	$ME = \pm \sqrt{((0.045 \text{ °C } (0.08 \text{ °F}) + 0.006\% * (MV - LRV))^2 + (0.03\% * MR)^2)}$
DIN 43760 IPTS-68	Ni100 (6)	-60 to +250 °C (-76 to +482 °F)	≤ 0.10 °C (0.19 °F)	$ME = \pm \sqrt{((0.04 \text{ °C } (0.07 \text{ °F}) - 0.004\% * (MV - LRV))^2 + (0.03\% * MR)^2)}$
	Ni120 (7)			
OIML R84: 2003 / GOST 6651-2009	Cu50 (10)	-180 to +200 °C (-292 to +392 °F)	≤ 0.15 °C (0.27 °F)	$ME = \pm \sqrt{((0.08 \text{ °C } (0.14 \text{ °F}) + 0.006\% * (MV - LRV))^2 + (0.03\% * MR)^2)}$
	Cu100 (11)	-180 to +200 °C (-292 to +392 °F)	≤ 0.13 °C (0.234 °F)	$ME = \pm \sqrt{((0.04 \text{ °C } (0.07 \text{ °F}) + 0.003\% * (MV - LRV))^2 + (0.03\% * MR)^2)}$
	Ni100 (12)	-60 to +180 °C (-76 to +356 °F)	≤ 0.08 °C (0.14 °F)	$ME = \pm \sqrt{((0.04 \text{ °C } (0.07 \text{ °F}) - 0.004\% * (MV - LRV))^2 + (0.03\% * MR)^2)}$
	Ni120 (13)			
OIML R84: 2003, GOST 6651-94	Cu50 (14)	-50 to +200 °C (-58 to +392 °F)	≤ 0.13 °C (0.234 °F)	$ME = \pm \sqrt{((0.09 \text{ °C } (0.16 \text{ °F}) + 0.004\% * (MV - LRV))^2 + (0.03\% * MR)^2)}$
Resistance transmitter	Resistance Ω	10 to 400 Ω	120.7mΩ	$ME = \pm \sqrt{(17 \text{ m}\Omega + 0.0032\% * (MV^2 + (0.03\% * MR)^2)}$
		10 to 2 000 Ω	623.4mΩ	$ME = \pm \sqrt{(60 \text{ m}\Omega + 0.006\% * (MV^2 + (0.03\% * MR)^2)}$

- 1) Maximum measured error for the specified measuring range.
- 2) Deviations from maximum measured error possible due to rounding.

Measured error for thermocouples (TC) and voltage transmitters

Standard	Designation	Measuring range	Measured error (±)	
			Maximum <sup>1)</sup>	Based on measured value <sup>2)</sup>
IEC 60584-1	Type A (30)	0 to +2 500 °C (+32 to +4 532 °F)	≤ 1.81 °C (3.26 °F)	$ME = \pm \sqrt{((1.0 \text{ °C } (1.8 \text{ °F}) + 0.026\% * (MV - LRV))^2 + (0.03\% * MR)^2)}$
	Type B (31)	+500 to +1 820 °C (+932 to +3 308 °F)	≤ 2.14 °C (3.85 °F)	$ME = \pm \sqrt{((2.1 \text{ °C } (3.8 \text{ °F}) - 0.09\% * (MV - LRV))^2 + (0.03\% * MR)^2)}$



Standard	Designation	Measuring range	Measured error ( $\pm$ )	
IEC 60584-1 / ASTM E988-96	Type C (32)	0 to +2000 °C (+32 to +3 632 °F)	$\leq 1.05$ °C (1.89 °F)	$ME = \pm \sqrt{((0.75 \text{ °C (1.35 °F)} + 0.0055\% * (MV - LRV))^2 + (0.03\% * MR)^2)}$
ASTM E988-96	Type D (33)		$\leq 1.25$ °C (2.26 °F)	$ME = \pm \sqrt{((1.1 \text{ °C (1.98 °F)} - 0.016\% * (MV - LRV))^2 + (0.03\% * MR)^2)}$
IEC 60584-1	Type E (34)	-150 to +1000 °C (-238 to +1832 °F)	$\leq 0.46$ °C (0.82 °F)	$ME = \pm \sqrt{((0.3 \text{ °C (0.54 °F)} - 0.012\% * (MV - LRV))^2 + (0.03\% * MR)^2)}$
	Type J (35)	-150 to +1200 °C (-238 to +2 192 °F)	$\leq 0.54$ °C (0.98 °F)	$ME = \pm \sqrt{((0.36 \text{ °C (0.65 °F)} - 0.01\% * (MV - LRV))^2 + (0.03\% * MR)^2)}$
	Type K (36)		$\leq 0.64$ °C (1.16 °F)	$ME = \pm \sqrt{((0.5 \text{ °C (0.9 °F)} - 0.01\% * (MV - LRV))^2 + (0.03\% * MR)^2)}$
	Type N (37)	-150 to +1300 °C (-238 to +2 372 °F)	$\leq 0.82$ °C (1.48 °F)	$ME = \pm \sqrt{((0.7 \text{ °C (1.26 °F)} - 0.025\% * (MV - LRV))^2 + (0.03\% * MR)^2)}$
	Type R (38)	+50 to +1768 °C (+122 to +3 214 °F)	$\leq 1.68$ °C (3.03 °F)	$ME = \pm \sqrt{((1.6 \text{ °C (2.88 °F)} - 0.04\% * (MV - LRV))^2 + (0.03\% * MR)^2)}$
	Type S (39)			$ME = \pm \sqrt{((1.60 \text{ °C (2.88 °F)} - 0.03\% * (MV - LRV))^2 + (0.03\% * MR)^2)}$
	Type T (40)	-150 to +400 °C (-238 to +752 °F)	$\leq 0.53$ °C (0.95 °F)	$ME = \pm \sqrt{((0.5 \text{ °C (0.9 °F)} - 0.05\% * (MV - LRV))^2 + (0.03\% * MR)^2)}$
DIN 43710	Type L (41)	-150 to +900 °C (-238 to +1 652 °F)	$\leq 0.5$ °C (0.9 °F)	$ME = \pm \sqrt{((0.39 \text{ °C (0.7 °F)} - 0.016\% * (MV - LRV))^2 + (0.03\% * MR)^2)}$
	Type U (42)	-150 to +600 °C (-238 to +1 112 °F)	$\leq 0.50$ °C (0.91 °F)	$ME = \pm \sqrt{((0.45 \text{ °C (0.81 °F)} - 0.04\% * (MV - LRV))^2 + (0.03\% * MR)^2)}$
GOST R8.8585-2001	Type L (43)	-200 to +800 °C (-328 to +1 472 °F)	$\leq 2.32$ °C (4.18 °F)	$ME = \pm \sqrt{((2.3 \text{ °C (4.14 °F)} - 0.015\% * (MV - LRV))^2 + (0.03\% * MR)^2)}$
<b>Voltage transmitter (mV)</b>		-20 to +100 mV	37.36 $\mu$ V	$ME = \pm \sqrt{((10.0 \mu\text{V} + 0.0018\% * (MV - LRV))^2 + (0.03\% * MR)^2)}$

- 1) Maximum measured error for the specified measuring range.
- 2) Deviations from maximum measured error possible due to rounding.

Total measured error of transmitter at current output =  $\sqrt{(\text{Measured error digital}^2 + \text{Measured error D/A}^2)}$

Sample calculation with Pt100, measuring range 0 to +200 °C (+32 to +392 °F), ambient temperature +35 °C (+95 °F), supply voltage 30 V:

Maximum measured error	0.09 °C (0.16 °F)
Influence of ambient temperature	0.08 °C (0.14 °F)
Influence of the supply voltage	0.06 °C (0.11 °F)

<b>Measured error analog value (current output):</b> $\sqrt{(\text{Measured error}^2 + \text{Influence of ambient temperature}^2 + \text{Influence of supply voltage}^2)}$	<b>0.13 °C (0.23 °F)</b>
---	--------------------------

The measured error data correspond to 2  $\sigma$  (Gaussian distribution).

Physical input measuring range of sensors	
10 to 400 $\Omega$	Cu50, Cu100, polynomial RTD, Pt50, Pt100, Ni100, Ni120
10 to 2 000 $\Omega$	Pt200, Pt500, Pt1000
-20 to 100 mV	Thermocouples type: A, B, C, D, E, J, K, L, N, R, S, T, U

Sensor adjustment

**Sensor transmitter matching**

RTD sensors are one of the most linear temperature measuring elements. Nevertheless, the output must be linearized. To significantly improve temperature measurement accuracy, the device allows the use of two methods:

- Callendar-Van Dusen coefficients (Pt100 resistance thermometer)

The Callendar-Van Dusen equation is described as:

$$R_T = R_0 [1 + AT + BT^2 + C(T - 100)T^3]$$

The coefficients A, B and C are used to match the sensor (platinum) and transmitter in order to improve the accuracy of the measuring system. The coefficients for a standard sensor are specified in IEC 751. If no standard sensor is available or if greater accuracy is required, the coefficients for each sensor can be determined specifically with the aid of sensor calibration.

- Linearization for copper/nickel resistance thermometers (RTD)

The polynomial equation for copper/nickel is as follows:

$$R_T = R_0 (1 + AT + BT^2)$$

The coefficients A and B are used for the linearization of nickel or copper resistance thermometers (RTD). The exact values of the coefficients derive from the calibration data and are specific to each sensor. The sensor-specific coefficients are then sent to the transmitter.

Sensor transmitter matching using one of the methods explained above significantly improves the temperature measurement accuracy of the entire system. This is because the transmitter uses the specific data pertaining to the connected sensor to calculate the measured temperature, instead of using the standardized sensor curve data.

**1-point adjustment (offset)**

Shifts the sensor value

Current output adjustment

Correction of the 4 or 20 mA current output value.

Operating influences                      The measured error data correspond to  $2 \sigma$  (Gaussian distribution).

*Influence of ambient temperature and supply voltage on operation for resistance thermometers (RTD) and resistance transmitters*

Designation	Standard	Ambient temperature: Influence ( $\pm$ ) per 1 °C (1.8 °F) change		Supply voltage: Influence ( $\pm$ ) per V change	
		Maximum	Based on measured value	Maximum	Based on measured value
Pt100 (1)	IEC 60751:2008	$\leq 0.013$ °C (0.023 °F)	0.0013% * (MV - LRV) + 0.003%, at least 0.003 °C (0.005 °F)	$\leq 0.007$ °C (0.013 °F)	0.0007% * (MV - LRV) + 0.003%, at least 0.003 °C (0.005 °F)
Pt200 (2)		$\leq 0.017$ °C (0.031 °F)	-	$\leq 0.009$ °C (0.016 °F)	-
Pt500 (3)		$\leq 0.008$ °C (0.014 °F)	0.0013% * (MV - LRV) + 0.003%, at least 0.006 °C (0.011 °F)	$\leq 0.004$ °C (0.007 °F)	0.0007% * (MV - LRV) + 0.003%, at least 0.006 °C (0.011 °F)
Pt1000 (4)		$\leq 0.005$ °C (0.009 °F)	-	$\leq 0.003$ °C (0.005 °F)	-
Pt100 (5)	JIS C1604:1984	$\leq 0.009$ °C (0.016 °F)	0.0013% * (MV - LRV) + 0.003%, at least 0.003 °C (0.005 °F)	$\leq 0.004$ °C (0.007 °F)	0.0007% * (MV - LRV) + 0.003%, at least 0.003 °C (0.005 °F)
Pt50 (8)	GOST 6651-94	$\leq 0.017$ °C (0.031 °F)	0.0015% * (MV - LRV) + 0.003%, at least 0.01 °C (0.018 °F)	$\leq 0.009$ °C (0.016 °F)	0.0007% * (MV - LRV) + 0.003%, at least 0.01 °C (0.018 °F)
Pt100 (9)		$\leq 0.013$ °C (0.023 °F)	0.0013% * (MV - LRV) + 0.003%, at least 0.003 °C (0.005 °F)	$\leq 0.007$ °C (0.013 °F)	0.0007% * (MV - LRV) + 0.003%, at least 0.003 °C (0.005 °F)
Ni100 (6)	DIN 43760 IPTS-68	$\leq 0.003$ °C (0.005 °F)	-	$\leq 0.001$ °C (0.002 °F)	-
Ni120 (7)		$\leq 0.003$ °C (0.005 °F)	-	$\leq 0.001$ °C (0.002 °F)	-
Cu50 (10)	OIML R84: 2003 / GOST 6651-2009	$\leq 0.005$ °C (0.009 °F)	-	$\leq 0.005$ °C (0.009 °F)	-
Cu100 (11)		$\leq 0.004$ °C (0.007 °F)	-	$\leq 0.004$ °C (0.007 °F)	-
Ni100 (12)		$\leq 0.003$ °C (0.005 °F)	-	$\leq 0.003$ °C (0.005 °F)	-
Ni120 (13)		$\leq 0.003$ °C (0.005 °F)	-	$\leq 0.003$ °C (0.005 °F)	-
Cu50 (14)	OIML R84: 2003 / GOST 6651-94	$\leq 0.005$ °C (0.009 °F)	-	$\leq 0.005$ °C (0.009 °F)	-
<b>Resistance transmitter (<math>\Omega</math>)</b>					
10 to 400 $\Omega$		$\leq 4$ m $\Omega$	0.001% * MV + 0.003%, at least 1 m $\Omega$	$\leq 2$ m $\Omega$	0.0005% * MV + 0.003%, at least 1 m $\Omega$
10 to 2000 $\Omega$		$\leq 20$ m $\Omega$	0.001% * MV + 0.003%, at least 10 m $\Omega$	$\leq 10$ m $\Omega$	0.0005% * MV + 0.003%, at least 5 m $\Omega$

*Influence of ambient temperature and supply voltage on operation for thermocouples (TC) and voltage transmitters*

Designation	Standard	Ambient temperature: Influence ( $\pm$ ) per 1 °C (1.8 °F) change		Supply voltage: Influence ( $\pm$ ) per V change	
		Maximum	Based on measured value	Maximum	Based on measured value
Type A (30)	IEC 60584-1	$\leq 0.07$ °C (0.126 °F)	0.003% * (MV - LRV) + 0.003%, at least 0.01 °C (0.018 °F)	$\leq 0.03$ °C (0.054 °F)	0.0012% * (MV - LRV) + 0.003%, at least 0.013 °C (0.023 °F)
Type B (31)		$\leq 0.04$ °C (0.072 °F)	-	$\leq 0.02$ °C (0.036 °F)	-
Type C (32)	IEC 60584-1 / ASTM E988-96	$\leq 0.04$ °C (0.072 °F)	0.0021% * (MV - LRV) + 0.003%, at least 0.01 °C (0.018 °F)	$\leq 0.02$ °C (0.036 °F)	0.0012% * (MV - LRV) + 0.003%, at least 0.013 °C (0.023 °F)
Type D (33)	ASTM E988-96	$\leq 0.04$ °C (0.072 °F)	0.0019% * (MV - LRV) + 0.003%, at least 0.01 °C (0.018 °F)	$\leq 0.02$ °C (0.036 °F)	0.0011% * (MV - LRV) + 0.003%, at least 0.0 °C (0.0 °F)
Type E (34)	IEC 60584-1	$\leq 0.02$ °C (0.036 °F)	0.0014% * (MV - LRV) + 0.003%, at least 0.0 °C (0.0 °F)	$\leq 0.01$ °C (0.018 °F)	0.0008% * (MV - LRV) + 0.003%, at least 0.0 °C (0.0 °F)

Designation	Standard	Ambient temperature: Influence (±) per 1 °C (1.8 °F) change		Supply voltage: Influence (±) per V change		
Type J (35)			0.0014% * (MV - LRV) + 0.003%, at least 0.0 °C (0.0 °F)		0.0008% * MV + 0.003%, at least 0.0 °C (0.0 °F)	
Type K (36)		≤ 0.02 °C (0.036 °F)	0.0015% * (MV - LRV) + 0.003%, at least 0.0 °C (0.0 °F)	≤ 0.01 °C (0.018 °F)	0.0009% * (MV - LRV) + 0.003%, at least 0.0 °C (0.0 °F)	
Type N (37)			0.0014% * (MV - LRV) + 0.003%, at least 0.010 °C (0.018 °F)		0.0008% * MV + 0.003%, at least 0.0 °C (0.0 °F)	
Type R (38)		≤ 0.03 °C (0.054 °F)	-	≤ 0.02 °C (0.036 °F)	-	
Type S (39)			-		-	
Type T (40)			-	0.0 °C (0.0 °F)	-	
Type L (41)		DIN 43710	≤ 0.01 °C (0.018 °F)	-	≤ 0.01 °C (0.018 °F)	-
Type U (42)				-	0.0 °C (0.0 °F)	-
Type L (43)		GOST R8.8585-2001		-	≤ 0.01 °C (0.018 °F)	-
<b>Voltage transmitter (mV)</b>						
-20 to 100 mV	-	≤ 1.5 µV	0.0015% * MV + 0.003%	≤ 0.8 µV	0.0008% * MV + 0.003%	

MV = Measured value

LRV = Lower range value of relevant sensor

Total measured error of transmitter at current output =  $\sqrt{(\text{Measured error digital}^2 + \text{Measured error D/A}^2)}$

Long-term drift, resistance thermometers (RTD) and resistance transmitters

Designation	Standard	Long-term drift (±) <sup>1)</sup>				
		after 1 month	after 6 months	after 1 year	after 3 years	after 5 years
		Based on measured value				
Pt100 (1)	IEC 60751:2008	≤ 0.039% * (MV - LRV) + 0.018% or 0.01 °C (0.02 °F)	≤ 0.061% * (MV - LRV) + 0.026% or 0.02 °C (0.04 °F)	≤ 0.007% * (MV - LRV) + 0.03% or 0.02 °C (0.04 °F)	≤ 0.0093% * (MV - LRV) + 0.036% or 0.03 °C (0.05 °F)	≤ 0.0102% * (MV - LRV) + 0.038% or 0.03 °C (0.05 °F)
Pt200 (2)		0.05 °C (0.09 °F)	0.05 °C (0.09 °F)	0.09 °C (0.17 °F)	0.12 °C (0.27 °F)	0.13 °C (0.24 °F)
Pt500 (3)		≤ 0.048% * (MV - LRV) + 0.018% or 0.01 °C (0.02 °F)	≤ 0.0075% * (MV - LRV) + 0.026% or 0.02 °C (0.04 °F)	≤ 0.068% * (MV - LRV) + 0.03% or 0.03 °C (0.06 °F)	≤ 0.011% * (MV - LRV) + 0.036% or 0.03 °C (0.05 °F)	≤ 0.0124% * (MV - LRV) + 0.038% or 0.04 °C (0.07 °F)
Pt1000 (4)		≤ 0.0077% * (MV - LRV) or 0.02 °C (0.04 °F)	≤ 0.0088% * (MV - LRV) + 0.03% or 0.02 °C (0.04 °F)	≤ 0.0114% * (MV - LRV) + 0.036% or 0.03 °C (0.05 °F)	≤ 0.013% * (MV - LRV) + 0.038% or 0.03 °C (0.05 °F)	
Pt100 (5)	JIS C1604:1984	≤ 0.039% * (MV - LRV) + 0.018% or 0.01 °C (0.02 °F)	≤ 0.0061% * (MV - LRV) + 0.026% or 0.02 °C (0.04 °F)	≤ 0.007% * (MV - LRV) + 0.03% or 0.02 °C (0.04 °F)	≤ 0.0093% * (MV - LRV) + 0.036% or 0.03 °C (0.05 °F)	≤ 0.0102% * (MV - LRV) + 0.038% or 0.03 °C (0.05 °F)
Pt50 (8)	GOST 6651-94	≤ 0.042% * (MV - LRV) + 0.018% or 0.02 °C (0.04 °F)	≤ 0.0068% * (MV - LRV) + 0.026% or 0.04 °C (0.07 °F)	≤ 0.0076% * (MV - LRV) + 0.03% or 0.04 °C (0.08 °F)	≤ 0.01% * (MV - LRV) + 0.036% or 0.06 °C (0.11 °F)	≤ 0.011% * (MV - LRV) + 0.038% or 0.07 °C (0.12 °F)
Pt100 (9)		≤ 0.016% * (MV - LRV) + 0.018% or 0.04 °C (0.07 °F)	≤ 0.0061% * (MV - LRV) + 0.026% or 0.02 °C (0.04 °F)	≤ 0.007% * (MV - LRV) + 0.03% or 0.02 °C (0.04 °F)	≤ 0.0093% * (MV - LRV) + 0.036% or 0.03 °C (0.05 °F)	≤ 0.0102% * (MV - LRV) + 0.038% or 0.03 °C (0.05 °F)
Ni100 (6)	DIN 43760 IPTS-68	0.01 °C (0.02 °F)	0.01 °C (0.02 °F)	0.02 °C (0.04 °F)	0.02 °C (0.04 °F)	0.02 °C (0.04 °F)
Ni120 (7)						
Cu50 (10)	OIML R84: 2003 /	0.02 °C (0.04 °F)	0.03 °C (0.05 °F)	0.04 °C (0.07 °F)	0.05 °C (0.09 °F)	0.05 °C (0.09 °F)
Cu100 (11)		0.01 °C (0.02 °F)	0.02 °C (0.04 °F)	0.02 °C (0.04 °F)	0.03 °C (0.05 °F)	0.04 °C (0.07 °F)

Designation	Standard	Long-term drift ( $\pm$ ) <sup>1)</sup>				
Ni100 (12)	GOST 6651-2009		0.01 °C (0.02 °F)	0.02 °C (0.04 °F)	0.02 °C (0.04 °F)	0.02 °C (0.04 °F)
Ni120 (13)						
Cu50 (14)	OIML R84: 2003 / GOST 6651-94	0.02 °C (0.04 °F)	0.03 °C (0.05 °F)	0.04 °C (0.07 °F)	0.05 °C (0.09 °F)	0.05 °C (0.09 °F)
<b>Resistance transmitter</b>						
10 to 400 $\Omega$		$\leq 0.003\% * MV$ + 0.018% or 4 m $\Omega$	$\leq 0.0048\% * MV$ + 0.026% or 6 m $\Omega$	$\leq 0.0055\% * MV$ + 0.03% or 7 m $\Omega$	$\leq 0.0073\% * MV$ + 0.036% or 10 m $\Omega$	$\leq 0.008\% * (MV - LRV) + 0.038\%$ or 11 m $\Omega$
10 to 2 000 $\Omega$		$\leq 0.0038\% * MV$ + 0.018% or 25 m $\Omega$	$\leq 0.006\% * MV$ + 0.026% or 40 m $\Omega$	$\leq 0.007\% * (MV - LRV) + 0.03\%$ or 47 m $\Omega$	$\leq 0.009\% * (MV - LRV) + 0.036\%$ or 60 m $\Omega$	$\leq 0.0067\% * (MV - LRV) + 0.038\%$ or 67 m $\Omega$

1) Whichever is greater

### Long-term drift, thermocouples (TC) and voltage transmitters

Designation	Standard	Long-term drift ( $\pm$ ) <sup>1)</sup>				
		after 1 month	after 6 months	after 1 year	after 3 years	after 5 years
		Based on measured value				
Type A (30)	IEC 60584-1	$\leq 0.021\% * (MV - LRV)$ + 0.018% or 0.34 °C (0.61 °F)	$\leq 0.037\% * (MV - LRV)$ + 0.026% or 0.59 °C (1.06 °F)	$\leq 0.044\% * (MV - LRV) + 0.03\%$ or 0.70 °C (1.26 °F)	$\leq 0.058\% * (MV - LRV) + 0.036\%$ or 0.93 °C (1.67 °F)	$\leq 0.063\% * (MV - LRV) + 0.038\%$ or 1.01 °C (1.82 °F)
Type B (31)		0.80 °C (1.44 °F)	1.40 °C (2.52 °F)	1.66 °C (2.99 °F)	2.19 °C (3.94 °F)	2.39 °C (4.30 °F)
Type C (32)	IEC 60584-1 / ASTM E988-96	0.34 °C (0.61 °F)	0.58 °C (1.04 °F)	0.70 °C (1.26 °F)	0.92 °C (1.66 °F)	1.00 °C (1.80 °F)
Type D (33)	ASTM E988-96	0.42 °C (0.76 °F)	0.73 °C (1.31 °F)	0.87 °C (1.57 °F)	1.15 °C (2.07 °F)	1.26 °C (2.27 °F)
Type E (34)	IEC 60584-1	0.13 °C (0.23 °F)	0.22 °C (0.40 °F)	0.26 °C (0.47 °F)	0.34 °C (0.61 °F)	0.37 °C (0.67 °F)
Type J (35)		0.15 °C (0.27 °F)	0.26 °C (0.47 °F)	0.31 °C (0.56 °F)	0.41 °C (0.74 °F)	0.44 °C (0.79 °F)
Type K (36)		0.17 °C (0.31 °F)	0.30 °C (0.54 °F)	0.36 °C (0.65 °F)	0.47 °C (0.85 °F)	0.51 °C (0.92 °F)
Type N (37)		0.25 °C (0.45 °F)	0.44 °C (0.79 °F)	0.52 °C (0.94 °F)	0.69 °C (1.24 °F)	0.75 °C (1.35 °F)
Type R (38)		0.62 °C (1.12 °F)	1.08 °C (1.94 °F)	1.28 °C (2.30 °F)	1.69 °C (3.04 °F)	1.85 °C (3.33 °F)
Type S (39)		0.62 °C (1.12 °F)		1.29 °C (2.32 °F)	1.70 °C (3.06 °F)	
Type T (40)		0.18 °C (0.32 °F)	0.32 °C (0.58 °F)	0.38 °C (0.68 °F)	0.50 °C (0.90 °F)	0.54 °C (0.97 °F)
Type L (41)	DIN 43710	0.12 °C (0.22 °F)	0.21 °C (0.38 °F)	0.25 °C (0.45 °F)	0.33 °C (0.59 °F)	0.36 °C (0.65 °F)
Type U (42)		0.18 °C (0.32 °F)	0.31 °C (0.56 °F)	0.37 °C (0.67 °F)	0.49 °C (0.88 °F)	0.53 °C (0.95 °F)
Type L (43)	GOST R8.8585-200 1	0.15 °C (0.27 °F)	0.26 °C (0.47 °F)	0.31 °C (0.56 °F)	0.41 °C (0.74 °F)	0.44 °C (0.79 °F)
<b>Voltage transmitter (mV)</b>						
- 20 to 100 mV		$\leq 0.012\% * MV$ + 0.018% or 4 $\mu V$	$\leq 0.021\% * MV$ + 0.026% or 7 $\mu V$	$\leq 0.025\% * MV$ + 0.03% or 8 $\mu V$	$\leq 0.033\% * MV$ + 0.036% or 11 $\mu V$	$\leq 0.036\% * MV$ + 0.038% or 12 $\mu V$

1) Whichever is greater

Influence of the reference junction	Pt100 DIN IEC 60751 Cl. B (internal reference junction with thermocouples TC) If an external 2-wire RTD is used for the reference junction measurement, the measured error caused by the transmitter is < 0.5 °C (0.9 °F). The measured error of the sensor element also needs to be added.
-------------------------------------	--

## 13.5 Environment

Ambient temperature range	-40 to +85 °C (-40 to +185 °F), for hazardous areas see Ex documentation
Storage temperature	<ul style="list-style-type: none"> <li>■ Head transmitter: -50 to +100 °C (-58 to +212 °F)</li> <li>■ DIN rail device: -50 to +100 °C (-58 to +212 °F)</li> </ul>
Altitude	Up to 4000 m (4374.5 yards) above mean sea level as per IEC 61010-1, CAN/CSA C22.2 No. 61010-1
Humidity	<ul style="list-style-type: none"> <li>■ Condensation: <ul style="list-style-type: none"> <li>■ Head transmitter permitted</li> <li>■ DIN rail transmitter not permitted</li> </ul> </li> <li>■ Max. rel. humidity: 95% as per IEC 60068-2-30</li> </ul>
Climate class	<ul style="list-style-type: none"> <li>■ Head transmitter: climate class C1 as per EN 60654-1</li> <li>■ DIN rail device: climate class B2 as per EN 60654-1</li> </ul>
Degree of protection	<ul style="list-style-type: none"> <li>■ Head transmitter with screw terminals: IP 00, with push-in terminals: IP 30. In installed state, depends on the terminal head or field housing used.</li> <li>■ When installing in field housing TA30A, TA30D or TA30H: IP 66/68 (NEMA Type 4x encl.)</li> <li>■ DIN rail device: IP 20</li> </ul>
Shock and vibration resistance	<p>Vibration resistance as per DNVGL-CG-0339 : 2015 and DIN EN 60068-2-27</p> <ul style="list-style-type: none"> <li>■ Head transmitter: 2 to 100 Hz at 4g (increased vibration stress)</li> <li>■ DIN rail device: 2 to 100 Hz at 0.7g (general vibration stress)</li> </ul> <p>Shock resistance as per KTA 3505 (section 5.8.4 Shock test)</p>
Electromagnetic compatibility (EMC)	<p><b>CE compliance</b></p> <p>Electromagnetic compatibility in accordance with all the relevant requirements of the IEC/EN 61326 series and NAMUR Recommendation EMC (NE21). For details, refer to the Declaration of Conformity. All tests were passed both with and without ongoing communication.</p> <p>Maximum measured error &lt;1% of measuring range.</p> <p>Interference immunity as per IEC/EN 61326 series, industrial requirements</p> <p>Interference emission as per IEC/EN 61326 series, Class B equipment</p>
Measuring category	Measuring category II as per IEC 61010-1. The measuring category is provided for measuring on power circuits that are directly connected electrically with the low-voltage network.

Degree of contamination Pollution degree 2 as per IEC 61010-1.

## 13.6 Mechanical construction

Design, dimensions Dimensions in mm (in)

### Head transmitter

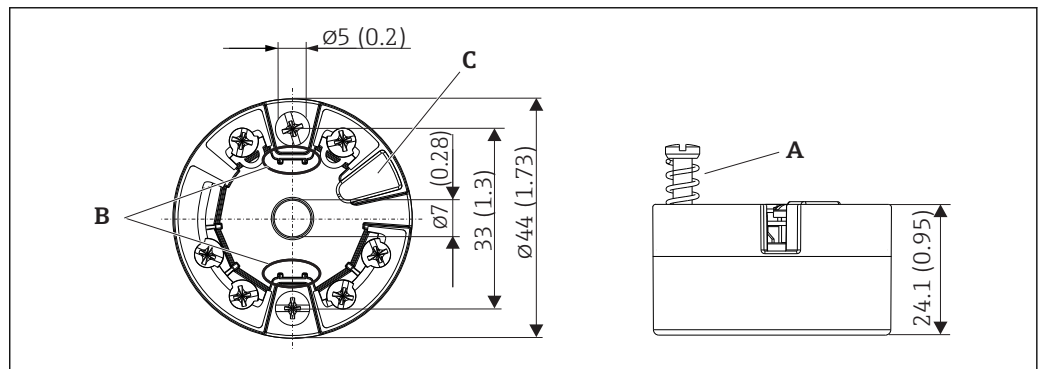

A0036303

19 Version with screw terminals

A Spring travel  $L \geq 5$  mm (not for US - M4 securing screws)

B Mounting elements for attachable measured value display TID10

C Interface for connecting measured value display or configuration tool

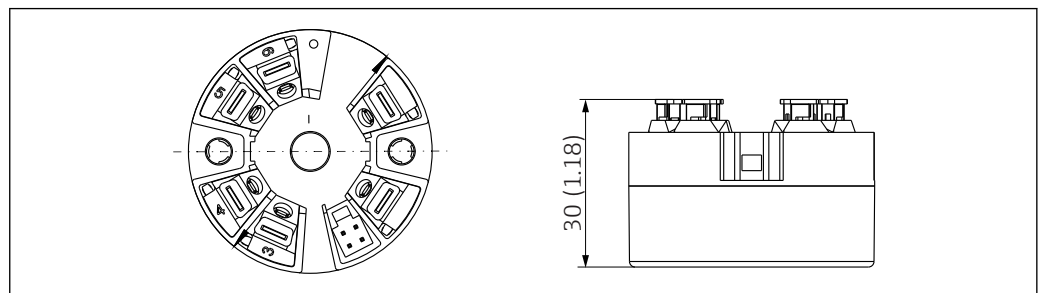

A0036304

20 Version with push-in terminals. Dimensions are identical to the version with screw terminals, apart from housing height.

DIN rail device

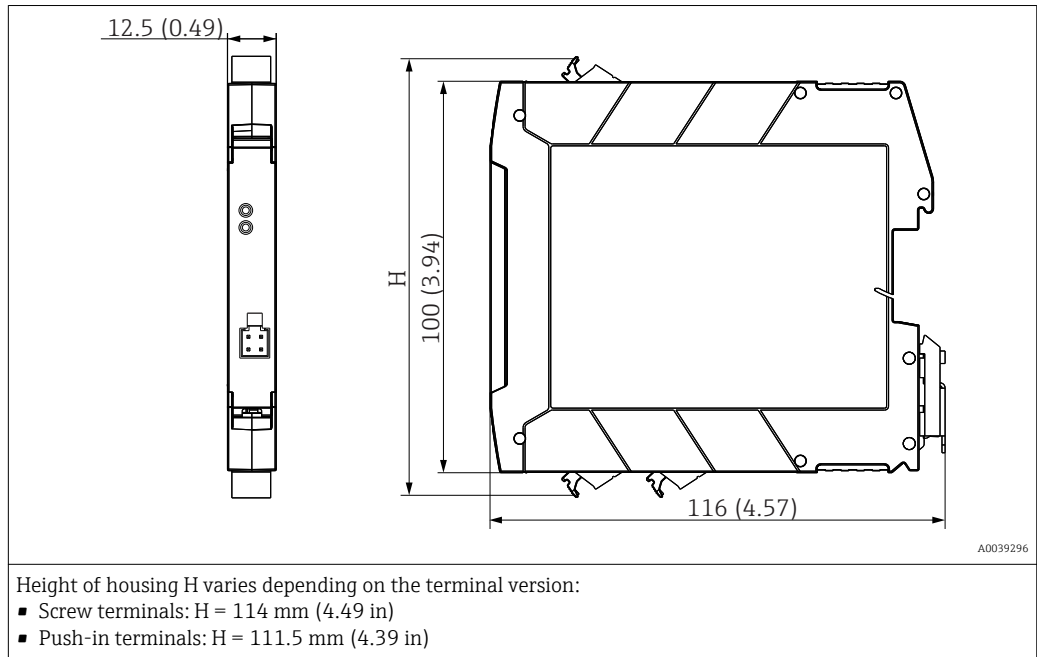

Field housing

All field housings have an internal geometry in accordance with DIN EN 50446, form B (flat face). Cable glands in the diagrams: M20x1.5

Maximum ambient temperatures for cable glands	
Type	Temperature range
Polyamide cable gland 1/2" NPT, M20x1.5 (non-Ex)	-40 to +100 °C (-40 to 212 °F)
Polyamide cable gland M20x1.5 (for dust ignition-proof area)	-20 to +95 °C (-4 to 203 °F)
Brass cable gland 1/2" NPT, M20x1.5 (for dust ignition-proof area)	-20 to +130 °C (-4 to +266 °F)

TA30A	Specification
<p style="text-align: right;">A0009820</p>	<ul style="list-style-type: none"> <li>■ Two cable entries</li> <li>■ Temperature: -50 to +150 °C (-58 to +302 °F) without cable gland</li> <li>■ Material: aluminum, polyester powder coated</li> <li>■ Seals: silicone</li> <li>■ Cable entry glands: 1/2" NPT and M20x1.5</li> <li>■ Color of head: blue, RAL 5012</li> <li>■ Color of cap: gray, RAL 7035</li> <li>■ Weight: 330 g (11.64 oz)</li> </ul>

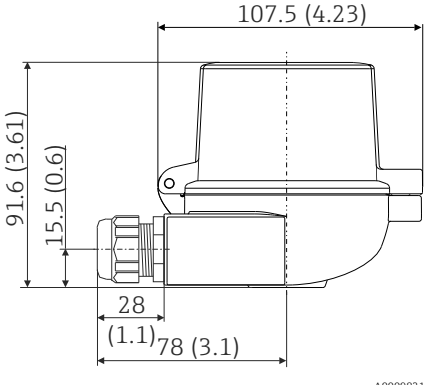

TA30A with display window in cover	Specification
 <p>A0009821</p>	<ul style="list-style-type: none"> <li>■ Two cable entries</li> <li>■ Temperature: -50 to +150 °C (-58 to +302 °F) without cable gland</li> <li>■ Material: aluminum, polyester powder coated</li> <li>■ Seals: silicone</li> <li>■ Cable entry glands: 1/2" NPT and M20x1.5</li> <li>■ Color of head: blue, RAL 5012</li> <li>■ Color of cap: gray, RAL 7035</li> <li>■ Weight: 420 g (14.81 oz)</li> </ul>

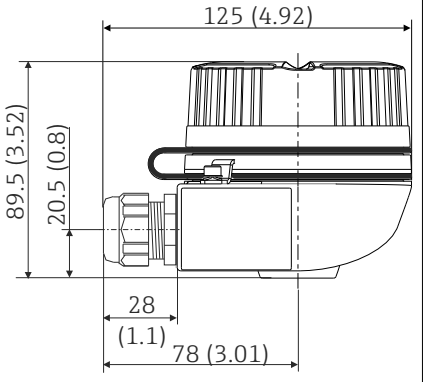
TA30H	Specification
 <p>A0009832</p>	<ul style="list-style-type: none"> <li>■ Flameproof (XP) version, explosion-protected, captive screw cap, with two cable entries</li> <li>■ Temperature: -50 to +150 °C (-58 to +302 °F) for rubber seal without cable gland (observe max. permitted temperature of cable gland!)</li> <li>■ Material: <ul style="list-style-type: none"> <li>■ Aluminum with polyester powder coating</li> <li>■ Stainless steel 316L without coating</li> </ul> </li> <li>■ Cable entry glands: 1/2" NPT, M20x1.5</li> <li>■ Color of aluminum head: blue, RAL 5012</li> <li>■ Color of aluminum cap: gray, RAL 7035</li> <li>■ Weight: <ul style="list-style-type: none"> <li>■ Aluminum: approx. 640 g (22.6 oz)</li> <li>■ Stainless steel: approx. 2 400 g (84.7 oz)</li> </ul> </li> </ul>

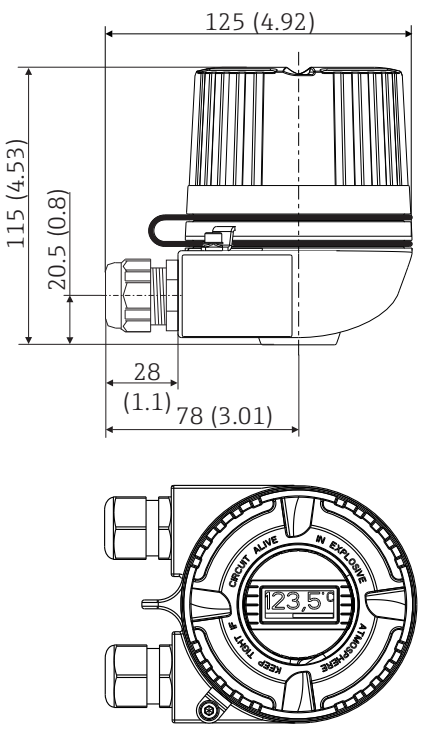
TA30H with display window in cover	Specification
 <p>A0009831</p>	<ul style="list-style-type: none"> <li>■ Flameproof (XP) version, explosion-protected, captive screw cap, with two cable entries</li> <li>■ Temperature: -50 to +150 °C (-58 to +302 °F) for rubber seal without cable gland (observe max. permitted temperature of cable gland!)</li> <li>■ Material: <ul style="list-style-type: none"> <li>■ Aluminum with polyester powder coating</li> <li>■ Stainless steel 316L without coating</li> </ul> </li> <li>■ Cable entry glands: 1/2" NPT, M20x1.5</li> <li>■ Color of aluminum head: blue, RAL 5012</li> <li>■ Color of aluminum cap: gray, RAL 7035</li> <li>■ Weight: <ul style="list-style-type: none"> <li>■ Aluminum: approx. 860 g (30.33 oz)</li> <li>■ Stainless steel: approx. 2 900 g (102.3 oz)</li> </ul> </li> </ul>

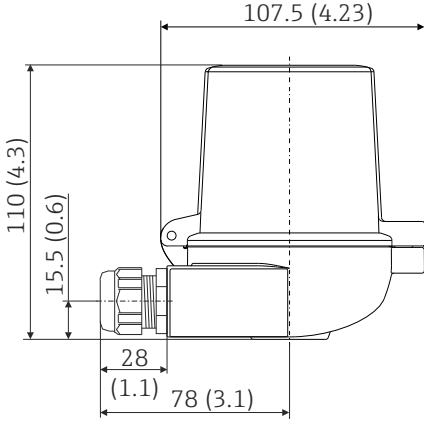
TA30D	Specification
 <p style="text-align: right; font-size: small;">A0009822</p>	<ul style="list-style-type: none"> <li>■ 2 cable entries</li> <li>■ Temperature: -50 to +150 °C (-58 to +302 °F) without cable gland</li> <li>■ Material: aluminum, polyester powder coated</li> <li>Seals: silicone</li> <li>■ Cable entry glands: 1/2" NPT and M20x1.5</li> <li>■ Two head transmitters can be mounted. In the standard configuration one transmitter is mounted in the terminal head cover and an additional terminal block is installed directly on the insert.</li> <li>■ Color of head: blue, RAL 5012</li> <li>■ Color of cap: gray, RAL 7035</li> <li>■ Weight: 390 g (13.75 oz)</li> </ul>

Weight	<ul style="list-style-type: none"> <li>■ Head transmitter: approx. 40 to 50 g (1.4 to 1.8 oz)</li> <li>■ Field housing: see specifications</li> <li>■ DIN rail device: approx. 100 g (3.53 oz)</li> </ul>
--------	---

Materials	<p>All the materials used are RoHS-compliant.</p> <ul style="list-style-type: none"> <li>■ Housing: polycarbonate (PC)</li> <li>■ Terminals: <ul style="list-style-type: none"> <li>■ Screw terminals: nickel-plated brass and gold-plated contacts</li> <li>■ Push-in terminals: tin-plated brass, contact springs 1.4310, 301 (AISI)</li> </ul> </li> <li>■ Potting compound: <ul style="list-style-type: none"> <li>■ Head transmitter: QSIL 553</li> <li>■ DIN rail housing: Silgel612EH</li> </ul> </li> </ul> <p>Field housing: see specifications</p>
-----------	--

### 13.7 Certificates and approvals

CE mark	The product meets the requirements of the harmonized European standards. As such, it complies with the legal specifications of the EC directives. The manufacturer confirms successful testing of the product by affixing to it the CE-mark.
---------	--

EAC mark	The product meets the legal requirements of the EEU guidelines. The manufacturer confirms the successful testing of the product by affixing the EAC mark.
----------	---

Ex approval	Information about currently available Ex versions (ATEX, FM, CSA, etc.) can be supplied by your E+H Sales Center on request. All explosion protection data are given in separate documentation which is available upon request.
-------------	---

CSA GP	CAN/CSA-C22.2 No. 61010-1, 2nd Edition
--------	--

Marine approvals	For the type approval certificates (DNVGL, BV etc.) currently available, please contact your Endress+Hauser Sales Center for information. All data relating to shipbuilding can be found in separate type approval certificates which can be requested as needed.
------------------	---

## Radio approval

The device has Bluetooth® radio approval in accordance with the Radio Equipment Directive (RED) and the Federal Communications Commission (FCC) 15.247 for the USA.

Europe	
This device meets the requirements of the Radio Equipment Directive RED 2014/53/EU:	<ul style="list-style-type: none"> <li>■ EN 300 328</li> <li>■ EN 301 489-1</li> <li>■ EN 301 489-17</li> </ul>

Kanada and USA	
<p>English:</p> <p>This device complies with Part 15 of the FCC Rules and with Industry Canada licenceexempt RSS standard(s).</p> <p>Operation is subject to the following two conditions:</p> <ul style="list-style-type: none"> <li>■ This device may not cause harmful interference, and</li> <li>■ This device must accept any interference received, including interference that may cause undesired operation.</li> </ul> <p>Changes or modifications made to this equipment not expressly approved by Endress+Hauser may void the user's authorization to operate this equipment.</p> <p>This equipment has been tested and found to comply with the limits for a Class B digital device, pursuant to part 15 of the FCC Rules. These limits are designed to provide reasonable protection against harmful interference in a residential installation. This equipment generates, uses and can radiate radio frequency energy and, if not installed and used in accordance with the instructions, may cause harmful interference to radio communications. However, there is no guarantee that interference will not occur in a particular installation.</p> <p>If this equipment does cause harmful interference to radio or television reception, which can be determined by turning the equipment off and on, the user is encouraged to try to correct the interference by one or more of the following measures:</p> <ul style="list-style-type: none"> <li>■ Reorient or relocate the receiving antenna.</li> <li>■ Increase the separation between the equipment and receiver.</li> <li>■ Connect the equipment into an outlet on a circuit different from that to which the receiver is connected.</li> <li>■ Consult the dealer or an experienced radio/TV technician for help.</li> </ul> <p>This equipment complies with FCC and IC radiation exposure limits set forth for an uncontrolled environment. This equipment should be installed and operated with minimum distance 20cm between the radiator and your body.</p>	<p>Français:</p> <p>Le présent appareil est conforme aux CNR d'industrie Canada applicables aux appareils radio exempts de licence.</p> <p>L'exploitation est autorisée aux deux conditions suivantes :</p> <ul style="list-style-type: none"> <li>■ L'appareil ne doit pas produire de brouillage, et</li> <li>■ L'utilisateur de l'appareil doit accepter tout brouillage radioélectrique subi, même si le brouillage est susceptible d'en compromettre le fonctionnement.</li> </ul> <p>Les changements ou modifications apportées à cet appareil non expressément approuvée par Endress +Hauser peut annuler l'autorisation de l'utilisateur d'opérer cet appareil.</p> <p>Déclaration d'exposition aux radiations: Cet équipement est conforme aux limites d'exposition aux rayonnements IC établies pour un environnement non contrôlé. Cet équipement doit être installé et utilisé avec un minimum de 20 cm de distance entre la source de rayonnement et votre corps.</p>

## MTTF

- Without Bluetooth® wireless technology: 168 years
- With Bluetooth® wireless technology: 123 years

according to EN ISO 13849-1

---

**Other standards and guidelines**

- IEC 60529:  
Degree of protection provided by housing (IP code)
- IEC/EN 61010-1:  
Safety requirements for electrical equipment for measurement, control and laboratory use
- IEC/EN 61326-Series:  
Electromagnetic compatibility (EMC requirements)
- This Class B digital apparatus complies with Canadian ICES-003  
Cet appareil numérique de la classe B est conforme à la norme NMB-003 du Canada.  
Compliance Label: CAN ICES-3 (B)/NMB-3(B)

## 13.8 Supplementary documentation

- Supplementary ATEX documentation:  
ATEX/IECEx: II1G Ex ia IIC T6...T4 Ga: XA01736T/09/a3  
ATEX II2G Ex d IIC: XA01007T/09/a3 (transmitter in field housing)  
ATEX II3G Ex ic IIC: XA01155T/09/a3  
ATEX II 3D, II 3G: XA01006T/09/a3
- Supplementary documentation CSA:  
XA01904T/09

## 14 Operating menu and parameter description

 The following tables list all the parameters in the "Guidance, Diagnostics, Application and System" operating menus. The page number refers to where a description of the parameter can be found.



Depending on the parameter configuration, not all submenus and parameters are available in every device. Information on this can be found in the parameter description under "Prerequisite".



This symbol  indicates how to navigate to the parameter using operating tools (e.g. FieldCare).



<b>Guidance</b> →	<b>Commissioning</b> →	 Commissioning wizard Start	→  33
-------------------	------------------------	---	--





<b>Guidance</b> →	Create documentation <sup>1)</sup>		
	Save / Restore <sup>1)</sup>		
	Compare <sup>1)</sup>		







1) These parameters only appear in FDT/DTM-based operating tools, such as Endress+Hauser's FieldCare and DeviceCare







<b>Diagnostics</b> →	<b>Actual diagnostics</b> →	Actual diagnostics 1	→  64
		Operating time	→  64









<b>Diagnostics</b> →	<b>Diagnostic list</b> →	Actual diagnostics 1, 2, 3	→  64
		Actual diag channel 1, 2, 3	→  64
		Time stamp 1, 2, 3	→  65







<b>Diagnostics</b> →	<b>Event logbook</b> →	Previous diagnostics n	→  65
		Previous diag n channel	→  65
		Time stamp n	→  66





<b>Diagnostics</b> →	<b>Simulation</b> →	Diagnostic event simulation	→  66
		Current output simulation	→  66
		Value current output	→  66
		Sensor simulation	→  67
		Sensor simulation value	→  67







<b>Diagnostics</b> →	<b>Diagnostic settings</b> →	<b>Properties</b> →	Alarm delay	→  67
			Limit corrosion detection	→  68
			Sensor line resistance	→  68
			Thermocouple diagnostic	→  68
		<b>Diagnostic behavior</b> →		→  68
		Sensor, electronics, process, configuration		
		<b>Status signal</b> →		→  69
		Sensor, electronics, process, configuration		





<b>Diagnostics</b> →	<b>Min/max values</b> →	Sensor min value	→  69
		Sensor max value	→  69
		Reset sensor min/max values	→  70
		Device temperature min.	→  70
		Device temperature max.	→  70
		Reset device temp. min/max values	→  70

<b>Application</b> →	<b>Measured values</b> →	Sensor value	→  70
		Sensor raw value	→  70
		Output current	→  70
		Percent of range	→  70
		Device temperature	→  70
		PV	→  71
		SV	→  71
		TV	→  72
	QV	→  72	

<b>Application</b> →	<b>Sensor</b> →	Unit	→  72
		Sensor type	→  72
		Connection type	→  73
		2-wire compensation	→  73
		Reference junction	→  73
		RJ preset value	→  74
		Sensor offset	→  74

<b>Application</b> →	<b>Sensor</b> →	<b>Linearization</b> →	Call./v. Dusen coeff. R0, A, B, C	→  74
			Polynomial coeff. R0, A, B	→  75
			Sensor lower limit	→  75
			Sensor upper limit	→  76

<b>Application</b> →	<b>Current output</b> →	4mA value	→  76
		20mA value	→  76
		Failure mode	→  76
		Failure current	→  77
		Current trimming 4 mA	→  77
		Current trimming 20 mA	→  78
		Damping	→  78

<b>System</b> →	<b>Device management</b> →	Device tag	→  79
		Mains filter	→  79
		Locking status	→  79
		Device reset	→  79

<b>System</b> →	<b>User management</b> →	<b>Define password</b> →	New Password	→ ⓘ 81
			Confirm new password	→ ⓘ 81
			Status password entry	→ ⓘ 81
	<b>Change user role</b> →		Password <sup>1)</sup>	→ ⓘ 82
			Status password entry	→ ⓘ 82
	<b>Recover password</b> →		Recover password	→ ⓘ 82
			Status password entry	→ ⓘ 82
	<b>Change password</b> →		Old password	→ ⓘ 83
			New Password	→ ⓘ 83
			Confirm new password	→ ⓘ 83
			Status password entry	→ ⓘ 83
	<b>Delete password</b> →		Delete password	→ ⓘ 83

1) The required user role must first be selected here when operating the device via the SmartBlue app.

<b>System</b> →	<b>Bluetooth configuration</b> →	Bluetooth	→ ⓘ 84
		Change Bluetooth password <sup>1)</sup>	→ ⓘ 84

1) Function is only visible in the SmartBlue app

<b>System</b> →	<b>Information</b> →	<b>Device</b> →	Serial number	→ ⓘ 84
			Order code	→ ⓘ 85
			Firmware version	→ ⓘ 85
			Hardware revision	→ ⓘ 85
			Extended order code (n) <sup>1)</sup>	→ ⓘ 85
			Device name	→ ⓘ 86
			Manufacturer	→ ⓘ 86

1) n = 1, 2, 3

<b>System</b> →	<b>Information</b> →	<b>Device location</b> →	Latitude	→ ⓘ 86
			Longitude	→ ⓘ 86
			Altitude	→ ⓘ 87
			Location method	→ ⓘ 87
			Location description	→ ⓘ 87
			Process unit TAG	→ ⓘ 87

<b>System</b> →	<b>Display</b> →	Display interval	→ ⓘ 88
		Format display	→ ⓘ 88
		Value 1 display	→ ⓘ 89
		Decimal places 1	→ ⓘ 89
		Value 2 display	→ ⓘ 89
		Decimal places 2	→ ⓘ 89
		Value 3 display	→ ⓘ 89
		Decimal places 3	→ ⓘ 89

## 14.1 Menu: Diagnostics

### 14.1.1 Submenu: Actual diagnostics

---

#### Actual diagnostics 1

---

<b>Navigation</b>	 Diagnostics → Actual diagnostics → Actual diagnostics 1
<b>Description</b>	Displays the current diagnostic message. If two or more messages occur simultaneously, the message with the highest priority is shown on the display.
<b>Additional information</b>	Example for display format: F041-Sensor interrupted

---

#### Operating time

---

<b>Navigation</b>	 Diagnostics → Actual diagnostics → Operating time
<b>Description</b>	Displays the length of time the device has been in operation.
<b>User interface</b>	Hours (h)

### 14.1.2 "Diagnostic list" submenu

 n = Number of diagnostic messages (n = 1 to 3)

---

#### Actual diagnostics n

---

<b>Navigation</b>	 Diagnostics → Actual diagnostics → Actual diagnostics n
<b>Description</b>	Displays the current diagnostic message. If two or more messages occur simultaneously, the message with the highest priority is shown on the display.
<b>Additional information</b>	Example for display format: F041-Sensor interrupted

---

#### Actual diag channel n

---

<b>Navigation</b>	 Diagnostics → Actual diagnostics → Actual diag channel n
<b>Description</b>	Displays the function module to which the diagnostic message refers.



---

<b>User interface</b>	<ul style="list-style-type: none"> <li>▪ Device</li> <li>▪ Sensor</li> <li>▪ Device temperature</li> <li>▪ Current output</li> <li>▪ Sensor RJ</li> </ul>
-----------------------	---

---

### Time stamp n

---

<b>Navigation</b>	 Diagnostics → Actual diagnostics → Time stamp n
<b>Description</b>	Displays the time stamp of the current diagnostic message in relation to the operating time.
<b>User interface</b>	Hours (h)

### 14.1.3 "Event logbook" submenu

 n = Number of diagnostic messages (n = 1 to 10). The last 10 messages are listed in chronological order.

---

### Previous diagnostics n

---

<b>Navigation</b>	 Diagnostics → Event logbook → Previous diagnostics n
<b>Description</b>	Displays the diagnostic messages that occurred in the past. The last 10 messages are listed in chronological order.
<b>User interface</b>	Symbol for event behavior and diagnostic event.
<b>Additional information</b>	Example for display format: F201-Electronics faulty

---

### Previous diag n channel

---

<b>Navigation</b>	 Diagnostics → Event logbook → Previous diag n channel
<b>Description</b>	Displays the function module to which the diagnostic message refers.
<b>User interface</b>	<ul style="list-style-type: none"> <li>▪ Device</li> <li>▪ Sensor</li> <li>▪ Device temperature</li> <li>▪ Current output</li> <li>▪ Sensor RJ</li> </ul>

---

**Time stamp n**

---



<b>Navigation</b>	 Diagnostics → Event logbook → Time stamp n
<b>Description</b>	Displays the time stamp of the current diagnostic message in relation to the operating time.
<b>User interface</b>	Hours (h)

### 14.1.4 "Simulation" submenu

---

**Diagnostic event simulation**



---

<b>Navigation</b>	 Diagnostics → Simulation → Diagnostic event simulation
<b>Description</b>	Switches diagnostic simulation on and off.
<b>Options</b>	Enter one of the diagnostic events using the dropdown menu →  39. The assigned status signals and diagnostic behaviors are used in the simulation mode. Select 'Off' to quit the simulation. Example: x043 Short circuit
<b>Factory setting</b>	Off

---

**Current output simulation**



---

<b>Navigation</b>	 Diagnostics → Simulation → Current output simulation
<b>Description</b>	Use this function to switch simulation of the current output on and off. The status signal indicates a category "C" diagnostic message ("function check") while the simulation is running.
<b>Options</b>	<ul style="list-style-type: none"> <li>■ Off</li> <li>■ On</li> </ul>
<b>Factory setting</b>	Off

---

**Value current output**

---

<b>Navigation</b>	 Diagnostics → Simulation → Value current output
-------------------	---

<b>Description</b>	Use this function to set a current value for the simulation. In this way, users can verify the correct adjustment of the current output and the correct function of downstream switching units.
<b>User entry</b>	3.58 to 23 mA
<b>Factory setting</b>	3.58 mA

---

### Sensor simulation

---

<b>Navigation</b>	 Diagnostics → Simulation → Sensor simulation
<b>Description</b>	Use this function to enable the simulation of the process variable. The simulation value of the selected process variable is defined in the <b>Sensor simulation value</b> parameter.
<b>Options</b>	<ul style="list-style-type: none"> <li>■ Off</li> <li>■ On</li> </ul>
<b>Factory setting</b>	Off

---

### Sensor simulation value

---

<b>Navigation</b>	 Diagnostics → Simulation → Sensor simulation value
<b>Description</b>	Use this function to enter a simulation value for the process variable. Subsequent measured value processing and the signal output use this simulation value. In this way, users can verify whether the measuring device has been configured correctly.
<b>User entry</b>	$-1.0 \cdot 10^{20}$ to $+1.0 \cdot 10^{20}$ °C
<b>Factory setting</b>	0.00 °C

## 14.1.5 "Diagnostic settings" submenu

### Submenu: Properties

---

### Alarm delay

---

<b>Navigation</b>	 Diagnostics → Diagnostic settings → Properties → Alarm delay
<b>Description</b>	Use this function to set the delay time during which a diagnostics signal is suppressed before it is output.
<b>User entry</b>	0 to 5 s

**Factory setting** 2 s

---

### Limit corrosion detection

---

**Navigation**  Diagnostics → Diagnostic settings → Properties → Limit corrosion detection

**Prerequisite** A 4-wire RTD or TC must be selected as the sensor type or connection type. →  72

**Description** Use this function to enter the limit value for corrosion detection. If this value is exceeded, the device behaves as defined in the diagnostic settings.

**User entry** 5 to 10 000 Ω

**Factory setting**

- 50.0 Ω for 4-wire RTD connection type
- 5 000 Ω for TC connection type

---

### Sensor line resistance

---

**Navigation**  Diagnostics → Diagnostic settings → Properties → Sensor line resistance

**Prerequisite** A 4-wire RTD or TC must be selected as the sensor type or connection type. →  72

**Description** Displays the highest measured resistance value of the sensor lines.

**User interface**  $-1.0 \cdot 10^{20}$  to  $+1.0 \cdot 10^{20}$  Ω

---

### Thermocouple diagnostic

---

**Navigation**  Diagnostics → Diagnostic settings → Properties → Thermocouple diagnostic

**Description** Use this function to switch off the "Sensor corrosion" and "Sensor break" diagnostic functions during thermocouple measurement.



This may be necessary in order to connect electronic simulators (e.g. calibrators) during a thermocouple measurement. The accuracy of the transmitter is not influenced by either the activation or deactivation of the thermocouple diagnostics function.

**Options**



- On
- Off

**Factory setting** On

---

### Diagnostic behavior



---

<b>Navigation</b>	 Diagnostics → Diagnostic settings → Diagnostic behavior
<b>Description</b>	Each diagnostic event is assigned a certain diagnostic behavior. The user can change this assignment for certain diagnostic events. →  39
<b>Options</b>	<ul style="list-style-type: none"> <li>■ Alarm</li> <li>■ Warning</li> <li>■ Disabled</li> </ul>
<b>Factory setting</b>	See the list of diagnostic events →  39

---

### Status signal

---

<b>Navigation</b>	 Diagnostics → Diagnostic settings → Status signal
<b>Description</b>	Each diagnostic event is assigned a certain status signal at the factory <sup>1)</sup> . The user can change this assignment for certain diagnostic events. →  39
	1) Digital information available via HART® communication
<b>Options</b>	<ul style="list-style-type: none"> <li>■ Failure (F)</li> <li>■ Function check (C)</li> <li>■ Out of specification (S)</li> <li>■ Maintenance required (M)</li> <li>■ No effect (N)</li> </ul>
<b>Factory setting</b>	See the list of diagnostic events →  39

### 14.1.6 "Min/max values" submenu

---

#### Sensor min value

---

<b>Navigation</b>	 Diagnostics → Min/max values → Sensor min value
<b>Description</b>	Displays the minimum temperature measured in the past at the sensor input (minimum indicator).

---

#### Sensor max. value

---

<b>Navigation</b>	 Diagnostics → Min/max values → Sensor max value
<b>Description</b>	Displays the maximum temperature measured in the past at the sensor input (peakhold indicator).

---

### Reset sensor min/max values

---

<b>Navigation</b>	 Diagnostics → Min/max values → Reset sensor min/max values
<b>Description</b>	Resets the min/max values of the sensor to their default values.
<b>User entry</b>	Clicking the <b>Reset sensor min/max values</b> activates the reset function. As a result of this action, the min/max values of the sensor only display the reset, temporary values.

---

### Device temperature min.

---

<b>Navigation</b>	 Diagnostics → Min/max values → Device temperature min.
<b>Description</b>	Displays the minimum electronics temperature measured in the past (minimum indicator).

---

### Device temperature max.

---

<b>Navigation</b>	 Diagnostics → Min/max values → Device temperature max.
<b>Description</b>	Displays the maximum electronics temperature measured in the past (maximum indicator).

---

### Reset device temp. min/max values

---

<b>Navigation</b>	 Diagnostics → Min/max values → Reset device temp. min/max values
<b>Description</b>	Resets the peakhold indicators for the minimum and maximum electronic temperatures measured.
<b>User entry</b>	Clicking the <b>Reset device temperature min/max values</b> activates the reset function. As a result of this action, the min/max values for the device temperature only display the reset, temporary values.

## 14.2 Menu: Application

### 14.2.1 Submenu: Measured values

---

#### Sensor value

---

---

<b>Navigation</b>	 Application → Measured values → Sensor value
<b>Description</b>	Displays the current measured value at the sensor input.

---

### Sensor raw value

---

<b>Navigation</b>	 Application → Measured values → Sensor raw value
<b>Description</b>	Displays the non-linearized mV/Ohm value at the specific sensor input.

---

### Output current

---

<b>Navigation</b>	 Application → Measured values → Output current
<b>Description</b>	Displays the calculated output current in mA.

---

### Percent of range

---

<b>Navigation</b>	 Application → Measured values → Percent of range
<b>Description</b>	Displays the measured value in percentage of the span

---

### Device temperature

---

<b>Navigation</b>	 Application → Measured values → Device temperature
<b>Description</b>	Displays the current electronics temperature.

---

### PV

---

<b>Navigation</b>	 Application → Measured values → PV
<b>Description</b>	Displays the primary device variables.

---

### SV

---

**Navigation**  Application → Measured values → SV

**Description** Displays the secondary device variables.

---

## TV

---

**Navigation**  Application → Measured values → TV

**Description** Displays the tertiary device variables.

---

## QV

---

**Navigation**  Application → Measured values → QV

**Description** Displays the quaternary (fourth) device variables.

### 14.2.2 Submenu: Sensor

---

## Unit

---

**Navigation**  Application → Sensor → Unit

**Description** Use this function to select the engineering unit for all the measured values.

**Options**

- °C
- °F
- K
- Ω
- mV

**Factory setting** °C

**Additional information**  Please note: if another unit has been selected instead of the factory setting (°C), all the set temperature values are converted to correspond to the configured temperature unit.  
Example: 150 °C is set as the upper range value. Following the selection of °F as the engineering unit, the new (converted) upper range value = 302 °F.



---

## Sensor type

---

**Navigation**  Application → Sensor → Sensor type



<b>Description</b>	Use this function to select the sensor type for the sensor input.  Please observe the terminal assignment when connecting the sensors. →  18
<b>Options</b>	A list of all the possible sensor types is provided in the "Technical data" section. →  45
<b>Factory setting</b>	Sensor type 1: Pt100 IEC751

---

### Connection type

---

<b>Navigation</b>	 Application → Sensor → Connection type
<b>Prerequisite</b>	An RTD sensor must be specified as the sensor type.
<b>Description</b>	Use this function to select the connection type for the sensor.
<b>Options</b>	2-wire, 3-wire, 4-wire
<b>Factory setting</b>	4-wire

---

### 2-wire compensation



---

<b>Navigation</b>	 Application → Sensor → 2-wire compensation
<b>Prerequisite</b>	An RTD sensor with a <b>2-wire</b> connection type must be specified as the sensor type.
<b>Description</b>	Use this function to specify the resistance value for two-wire compensation in RTDs.
<b>User entry</b>	0 to 30 Ω
<b>Factory setting</b>	0 Ω

---

### Reference junction

---

<b>Navigation</b>	 Application → Sensor → Reference junction
<b>Prerequisite</b>	A thermocouple (TC) sensor must be selected as the sensor type.
<b>Description</b>	Use this function to select reference junction measurement for temperature compensation of thermocouples (TC).  If <b>Preset value</b> is selected, the compensation value is specified via the <b>RJ preset value</b> parameter.

<b>Options</b>	<ul style="list-style-type: none"> <li>■ Internal measurement: the internal reference junction temperature is used.</li> <li>■ Fixed value: a fixed value is used.</li> <li>■ Measured value of the external sensor: the measured value of the connected sensor is used.</li> </ul>
----------------	---

<b>Factory setting</b>	Internal measurement
------------------------	----------------------

---

### RJ preset value

---

<b>Navigation</b>	 Application → Sensor → RJ preset value
<b>Prerequisite</b>	The <b>Preset value</b> parameter must be set if the <b>Fixed value</b> option is selected.
<b>Description</b>	Use this function to define the fixed preset value for temperature compensation.
<b>User entry</b>	-58 to +360
<b>Factory setting</b>	0.00

---

### Sensor offset

---

<b>Navigation</b>	 Application → Sensor → Sensor offset
<b>Description</b>	Use this function to set the zero point correction (offset) of the sensor measured value. The value indicated is added to the measured value.
<b>User entry</b>	-18.0 to +18.0
<b>Factory setting</b>	0.0

### 14.2.3 Submenu: Linearization

---

#### Call./v. Dusen coeff. R0

---

<b>Navigation</b>	 Application → Sensor → Linearization → Call./v. Dusen coeff. R0
<b>Prerequisite</b>	The RTD platinum (Callendar/Van Dusen) option is enabled in the <b>Sensor type</b> parameter.
<b>Description</b>	Use this function to set the R0 Value only for linearization with the Callendar/Van Dusen polynomial.
<b>User entry</b>	1 to 2 000
<b>Factory setting</b>	100.000 Ω

---

**Call./v. Dusen coeff. A, B and C**



---

<b>Navigation</b>	 Application → Sensor → Linearization → Call./v. Dusen coeff. A, B and C
<b>Prerequisite</b>	The RTD platinum (Callendar/Van Dusen) option is enabled in the <b>Sensor type</b> parameter.
<b>Description</b>	Use this function to set the coefficients for sensor linearization based on the Callendar/Van Dusen method.
<b>Factory setting</b>	<ul style="list-style-type: none"> <li>■ A: 3.90830e-003</li> <li>■ B: -5.77500e-007</li> <li>■ C: -4.18300e-012</li> </ul>

---

**Polynomial coeff. R0**



---

<b>Navigation</b>	 Application → Sensor → Linearization → Polynomial coeff. R0
<b>Prerequisite</b>	The RTD poly nickel or RTD copper polynomial option is enabled in the <b>Sensor type</b> parameter.
<b>Description</b>	Use this function to set the R0 Value only for linearization of nickel/copper sensors.
<b>User entry</b>	1 to 20 000 Ω
<b>Factory setting</b>	100.00 Ω

---

**Polynomial coeff. A, B**



---

<b>Navigation</b>	 Application → Sensor → Linearization → Polynomial coeff. Polynomial coeff. A, B
<b>Prerequisite</b>	The RTD poly nickel or RTD copper polynomial option is enabled in the <b>Sensor type</b> parameter.
<b>Description</b>	Use this function to set the coefficients for sensor linearization of copper/nickel resistance thermometers.
<b>Factory setting</b>	Polynomial coeff. A = 5.49630e-003 Polynomial coeff. B = 6.75560e-006

---

**Sensor lower limit**

---

<b>Navigation</b>	 Application → Sensor → Linearization → Sensor lower limit
-------------------	---

<b>Prerequisite</b>	The RTD platinum, RTD poly nickel or RTD copper polynomial option is enabled in the <b>Sensor type</b> parameter.
<b>Description</b>	Use this function to set the lower calculation limit for special sensor linearization.
<b>User entry</b>	Depends on the <b>sensor type</b> selected.
<b>Factory setting</b>	Depends on the <b>sensor type</b> selected.

---

### Sensor upper limit

---

<b>Navigation</b>	 Application → Sensor → Linearization → Sensor upper limit
<b>Prerequisite</b>	The RTD platinum, RTD poly nickel or RTD copper polynomial option is enabled in the <b>Sensor type</b> parameter.
<b>Description</b>	Use this function to set the upper calculation limit for special sensor linearization.
<b>User entry</b>	Depends on the <b>sensor type</b> selected.
<b>Factory setting</b>	Depends on the <b>sensor type</b> selected.

## 14.2.4 Submenu: Current output

---

### 4mA value

---

<b>Navigation</b>	 Application → Current output → 4mA value
<b>Description</b>	Use this function to assign a measured value to the current value 4 mA.
<b>Factory setting</b>	0 °C

---

### 20mA value

---

<b>Navigation</b>	 Application → Current output → 20mA value
<b>Description</b>	Use this function to assign a measured value to the current value 20 mA.
<b>Factory setting</b>	100 °C

---

### Failure mode

---

<b>Navigation</b>	 Application → Current output → Failure mode
<b>Description</b>	Use this function to select the signal on alarm level of the current output in the event of an error.
<b>Options</b>	<ul style="list-style-type: none"> <li>■ High alarm</li> <li>■ Low alarm</li> </ul>
<b>Factory setting</b>	Low alarm

---

### Failure current

---

<b>Navigation</b>	 Application → Current output → Failure current
<b>Prerequisite</b>	The <b>High alarm</b> option is enabled in the "Failure mode" parameter.
<b>Description</b>	Use this function to set the value the current output adopts in an alarm condition.
<b>User entry</b>	21.5 to 23 mA
<b>Factory setting</b>	22.5

#### Adjustment of the analog output (4 and 20 mA current trimming)

Current trimming is used to compensate the analog output (D/A conversion). Here, the output current of the transmitter must be adapted so that it suits the value expected at the higher-level system.

##### *Procedure*

1. Start
⇓
2. Install an accurate ammeter (more accurate than the transmitter) in the current loop.
⇓
3. Switch on current output simulation and set the simulation value to 4 mA.
⇓
4. Measure the loop current with the ammeter and make a note of the value.
⇓
5. Set the simulation value to 20 mA.
⇓
6. Measure the loop current with the ammeter and make a note of the value.
⇓
7. Enter the current values determined as adjustment values in the <b>Current trimming 4 mA / 20 mA</b> parameters
⇓
8. End

---

### Current trimming 4 mA

---

---

<b>Navigation</b>	 Application → Current output → Current trimming 4 mA
<b>Description</b>	Use this function to set the correction value for the current output at the start of the measuring range at 4 mA.
<b>User entry</b>	3.5 to 4.25 mA
<b>Factory setting</b>	4 mA
<b>Additional information</b>	The trimming only affects the current loop values from 3.8 to 20.5 mA. The failure mode with <b>low alarm</b> and <b>high alarm</b> current values is not subject to trimming.

---

### Current trimming 20 mA

---

<b>Navigation</b>	 Application → Current output → Current trimming 20 mA
<b>Description</b>	Use this function to set the correction value for the current output at the end of the measuring range at 20 mA.
<b>User entry</b>	19.50 to 20.5 mA
<b>Factory setting</b>	20.000 mA
<b>Additional information</b>	The trimming only affects the current loop values from 3.8 to 20.5 mA. The failure mode with <b>low alarm</b> and <b>high alarm</b> current values is not subject to trimming.

---

### Damping

---

<b>Navigation</b>	 Application → Current output → Damping
<b>Description</b>	Use this function to set the time constant for current output damping.
<b>User entry</b>	0 to 120 s
<b>Factory setting</b>	0 s
<b>Additional information</b>	The current output responds to fluctuations in the measured value with an exponential delay. The time constant of this delay is defined by this parameter. If a low time constant is entered, the current output responds quickly to the measured value. On the other hand, the response of the current output is delayed if a high time constant is entered.

## 14.3 Menu: System

### 14.3.1 Submenu: Device management

---

#### Device tag

---

<b>Navigation</b>	 System → Device management → Device tag
<b>Description</b>	Use this function to enter a unique name for the measuring point so it can be identified quickly within the plant.
<b>User entry</b>	Max. 32 characters, such as letters, numbers or special characters (e.g. @, %, /)
<b>Factory setting</b>	Depends on the product root and serial number

---

#### Mains filter

---

<b>Navigation</b>	 System → Device management → Mains filter
<b>Description</b>	Use this function to select the mains filter for A/D conversion.
<b>Options</b>	<ul style="list-style-type: none"> <li>■ 50 Hz</li> <li>■ 60 Hz</li> </ul>
<b>Factory setting</b>	50 Hz

---

#### Locking status

---

<b>Navigation</b>	 System → Device management → Locking status
<b>Description</b>	Displays the device locking status. When write protection is activated, write access to the parameters is disabled.
<b>User interface</b>	Enabled or disabled check box: <b>Locked by hardware</b>

---

#### Device reset

---

<b>Navigation</b>	 System → Device management → Device reset
<b>Description</b>	Use this function to reset the device configuration - either entirely or in part - to a defined state.

**Options**

- **Not active**  
No action is executed and the user exits the parameter.
- **To factory defaults**  
All the parameters are reset to the factory setting.
- **To delivery settings**  
All parameters are reset to the order configuration. The order configuration can differ from the factory setting if customer-specific parameter values were defined when the device was ordered.
- **Restart device**  
The device is restarted but the device configuration remains unchanged.

**Factory setting**

Not active

**14.3.2 User management submenu**

<b>Define password</b> → Maintenance	New Password
	Confirm new password
	Status password entry
<b>Change user role</b> → Operator	Password <sup>1)</sup>
	Status password entry
<b>Recover password</b> → Operator	Recover password
	Status password entry
<b>Change password</b> → Maintenance	Old password
	New Password
	Confirm new password
	Status password entry
<b>Delete password</b> → Maintenance	Delete password

1) The required user role must first be selected here when operating the device via the SmartBlue app.

Navigation in the submenu is supported by the following operating elements:

- **Back**  
Return to the previous page
- **Cancel**  
If Cancel is selected, the status before the submenu was started is restored

---

**Define password**

---

**Navigation**

 System → User management → Define password

**Description**

Use this function to start password definition

**User entry**



Activate the button



---

## New password

---

<b>Navigation</b>	 System → User management → Define password → New password
<b>Description</b>	Use this function to enter a password for the <b>Maintenance</b> user role to gain access to the relevant functions.
<b>Additional information</b>	<p>If the factory setting is not changed, the device is set to the <b>Maintenance</b> user role. This means that the device's configuration data are not write-protected and can be edited at all times.</p> <p>Once a password has been defined, devices can be switched to the <b>Maintenance</b> user role if the correct password is entered in the <b>Password</b> parameter. A new password becomes valid once it has been verified after being entered in the <b>Confirm new password</b> parameter.</p> <p> The password must contain a minimum of 4 and a maximum of 16 characters and can consist of both letters and numbers. Leading and trailing spaces not used as part of the password. If you lose your password, please contact your Endress+Hauser Sales Center.</p>
<b>User entry</b>	..... (enter the password)

---

## Confirm new password

---

<b>Navigation</b>	 System → User management → Define password → Confirm new password
<b>Description</b>	Use this function to confirm the new password that has been defined.
<b>Additional information</b>	<p>A new password becomes valid once it has been verified after being entered in the <b>Confirm new password</b> parameter.</p> <p>The password must contain a minimum of 4 and a maximum of 16 characters and can consist of both letters and numbers. If you lose your password, please contact your Endress+Hauser Sales Center.</p>
<b>User entry</b>	..... (enter the password)

---

## Status password entry

---

<b>Navigation</b>	 System → User management → Define password → Status password entry
-------------------	--

**Description** Displays the status of the password verification.

- Password accepted
- Wrong password
- Password rules violated
- Permission denied
- Incorrect input sequence
- Invalid user role
- Confirm PW mismatch
- Reset password accepted

**Enter password**

**Navigation**  System → User management → Enter password

**Prerequisite** The **Operator** user role is active and a password has been defined.

**Description** Use this function to enter a password for the selected user role to gain access to the functions of this role.

**User entry** Enter the defined password.

**Status password entry**

**Navigation**  System → User management → Enter password → Status password entry

**Description** →  82

**Recover password**

**Navigation**  System → User management → Recover password

**Prerequisite** The **Operator** user role is active and a password has already been defined.

**Description** Use this function to enter the reset code to reset the current password.





**Current password is lost.**

- ▶ Only use the reset code if you have lost the current password. Contact the Endress +Hauser Sales Center.

**User entry** Activate the text box and enter the reset code.

**Status password entry**

---

<b>Navigation</b>	 System → User management → Recover password → Status password entry
<b>Description</b>	→  82

---

### Logout



---

<b>Navigation</b>	 System → User management → Logout
<b>Prerequisite</b>	The <b>Maintenance</b> user role must be active.
<b>Description</b>	The <b>Maintenance</b> user role is exited and the system switches to the <b>Operator</b> user role.
<b>User entry</b>	Activate the button.

---

### Change password



---

<b>Navigation</b>	 System → User management → Change password
<b>Prerequisite</b>	The <b>Maintenance</b> user role must be active.
<b>Description</b>	<ul style="list-style-type: none"> <li>▪ Old password: Use this function to enter the current password to then be able to make changes to the existing password.</li> <li>▪ New password: →  80</li> <li>▪ Confirm new password: →  80</li> </ul>
<b>User entry</b>	<ul style="list-style-type: none"> <li>▪ ..... (enter the old password)</li> <li>▪ ..... (enter the new password)</li> <li>▪ ..... (confirm the new password)</li> </ul>

---

### Status password entry

---

<b>Navigation</b>	 System → User management → Change password → Status password entry
<b>Description</b>	→  82

---

### Delete password

---

<b>Navigation</b>	 System → User management → Delete password
<b>Prerequisite</b>	The <b>Maintenance</b> user role must be active.

**Description** The password currently valid is deleted.  
The **Define password** button appears.

**User entry** Activate the **Delete password** button.

### 14.3.3 Bluetooth configuration submenu

---

#### Bluetooth

---

**Navigation**  System → Bluetooth configuration → Bluetooth

**Description** Use this function to enable or disable the Bluetooth function.

- Off: The Bluetooth interface is disabled immediately.
- On: The Bluetooth interface is enabled and a connection to the device can be established.

 Bluetooth communication is only possible if the CDI and display interface is not used.

**Options**

- Off
- On

**Factory setting** On

---

#### Change Bluetooth password <sup>1)</sup>

---

1) Function is only visible in the SmartBlue app

**Navigation**  System → Bluetooth configuration → Change Bluetooth password

**Description** Use this function to change the Bluetooth password. This function is visible in the SmartBlue app only.

**Prerequisite** The Bluetooth interface is enabled (ON) and a connection to the device is established.

**User entry** Enter:

- User name
- Current password
- New Password
- Confirm new password

Press OK to confirm your entries.

### 14.3.4 Information submenu

#### Device submenu

---

#### Serial number

---

**Navigation**  System → Information → Device → Serial number

**Description** Displays the serial number of the device. It can also be found on the nameplate.



**Uses of the serial number**

- To identify the measuring device quickly, e.g. when contacting Endress+Hauser.
- To obtain specific information on the measuring device using the Device Viewer: [www.endress.com/deviceviewer](http://www.endress.com/deviceviewer)

**User interface** Max. 11-digit character string comprising letters and numbers.

## Order code

**Navigation**  System → Information → Device → Order code

**Description** Displays the order code of the device. It can also be found on the nameplate. The order code is generated from the extended order code, which defines all the device features of the product structure. In contrast, the device features cannot be read directly from the order code.



**Uses of the order code**

- To order an identical spare device.
- To identify the device quickly and easily, e.g. when contacting Endress+Hauser.

## Firmware version

**Navigation**  System → Information → Device → Firmware version

**Description** Displays the device firmware version installed.

**User interface** Max. 6-digit character string in the format xx.yy.zz

## Hardware revision

**Navigation**  System → Information → Device → Hardware revision

**Description** Displays the hardware revision of the device.

## Extended order code (n)



n = Number of parts of the extended order code (n = 1 to 3)

**Navigation**  System → Information → Device → Extended order code n

---

<b>Description</b>	<p>Displays the first, second and/or third part of the extended order code. On account of length restrictions, the extended order code is split into a maximum of 3 parameters. The extended order code indicates the version of all the features of the product structure for the device and thus uniquely identifies the device. It can also be found on the nameplate.</p> <ul style="list-style-type: none"> <li>▪ Uses of the extended order code</li> <li>▪ To order an identical spare device.</li> <li>▪ To check the ordered device features using the delivery note.</li> </ul>
--------------------	---

---

### Device name

---

<b>Navigation</b>	 System → Information → Device → Device name
-------------------	---

<b>Description</b>	Displays the device name. It can also be found on the nameplate.
--------------------	--

---

### Manufacturer

---

<b>Navigation</b>	 System → Information → Device → Manufacturer
-------------------	---

<b>Description</b>	Displays the name of the manufacturer.
--------------------	--

### Device location submenu

---

#### Latitude

---

<b>Navigation</b>	 System → Information → Device location → Latitude
-------------------	---

<b>Description</b>	Use this function to enter the latitude coordinates that describe the device location.
--------------------	--

<b>User entry</b>	-90.000 to +90.000 °
-------------------	----------------------

<b>Factory setting</b>	0
------------------------	---

---

#### Longitude

---

<b>Navigation</b>	 System → Information → Device location → Longitude
-------------------	--

<b>Description</b>	Use this function to enter the longitude coordinates that describe the device location.
--------------------	---

<b>User entry</b>	-180.000 to +180.000 °
-------------------	------------------------

<b>Factory setting</b>	0
------------------------	---

---

**Altitude**



---

<b>Navigation</b>	 System → Information → Device location → Altitude
<b>Description</b>	Use this function to enter the altitude data that describe the device location.
<b>User entry</b>	$-1.0 \cdot 10^{+20}$ to $+1.0 \cdot 10^{+20}$ m
<b>Factory setting</b>	0 m

---

**Location method**



---

<b>Navigation</b>	 System → Information → Device location → Location method
<b>Description</b>	Use this function to select the data format for specifying the geographic location. The codes for specifying the location are based on the US National Marine Electronics Association (NMEA) Standard NMEA 0183.
<b>Options</b>	<ul style="list-style-type: none"> <li>■ No fix</li> <li>■ GPS or Standard Positioning Service (SPS) fix</li> <li>■ Differential PGS fix</li> <li>■ Precise positioning service (PPS)</li> <li>■ Real Time Kinetic (RTK) fixed solution</li> <li>■ Real Time Kinetic (RTK) float solution</li> <li>■ Estimated dead reckoning</li> <li>■ Manual input mode</li> <li>■ Simulation mode</li> </ul>
<b>Factory setting</b>	Manual input mode

---

**Location description**

---

<b>Navigation</b>	 System → Information → Device location → Location description
<b>Description</b>	Use this function to enter a description of the location so that the device can be located in the plant.
<b>User entry</b>	Up to 32 alphanumeric characters (letters, numbers and special characters)
<b>Factory setting</b>	32 x '?'

---

**Process unit tag**

---

<b>Navigation</b>	 System → Information → Device location → Process unit tag
-------------------	---



<b>Description</b>	Use this function to enter the process unit in which the device is installed.
<b>User entry</b>	Up to 32 alphanumeric characters (letters, numbers and special characters)
<b>Factory setting</b>	32 x '?'

### 14.3.5 Submenu: Display

---

#### Display interval

---

<b>Navigation</b>	 System → Display → Display interval
<b>Description</b>	Use this function to set the length of time the measured values are displayed if the values alternate on the local display. This type of change is only generated automatically if several measured values are specified. <ul style="list-style-type: none"> <li> The <b>Value 1 display - Value 3 display</b> parameters are used to specify which measured values are shown on the local display.</li> <li>The display format of the displayed measured values is specified using the <b>Format display</b> parameter.</li> </ul>
<b>User entry</b>	4 to 20 s
<b>Factory setting</b>	4 s

---

#### Format display

---

<b>Navigation</b>	 System → Display → Format display
<b>Description</b>	Use this function to select how the measured value is shown on the local display. The display format <b>Measured value</b> or <b>Measured value with bar graph</b> can be configured.
<b>Options</b>	<ul style="list-style-type: none"> <li>■ Value</li> <li>■ Value + bar graph</li> </ul>
<b>Factory setting</b>	Value

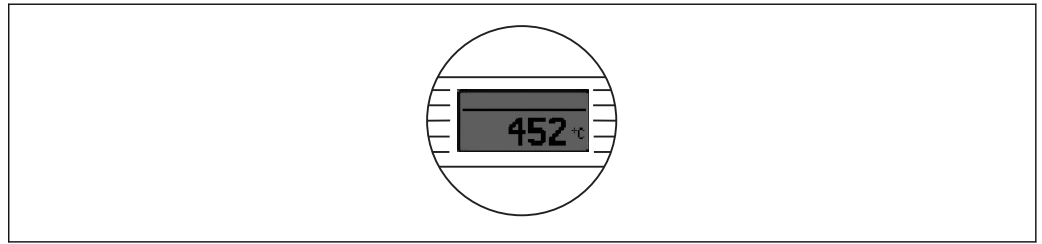

**Additional information***Value*

A0014564

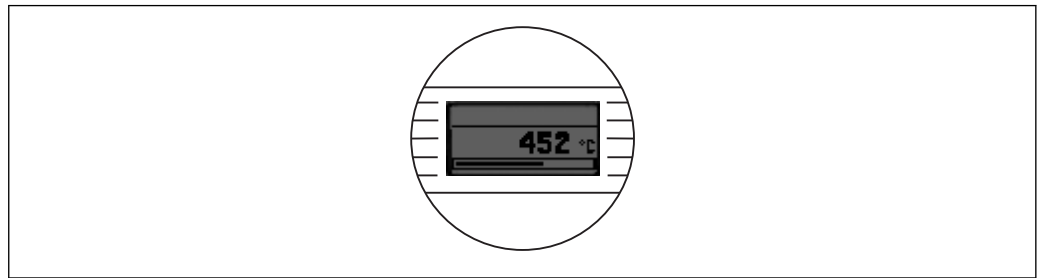
*Value + bar graph*

A0014563

**Value 1 display** (Value 2 or 3 display)**Navigation**
 System → Display → Format display → Value 1 display (Value 2 or 3 display)
**Description**

Use this function to select one of the measured values shown on the local display.

 The **Format display** parameter is used to specify how the measured values are displayed.

**Options**

- Process value
- Device temperature
- Output current
- Percent of range
- Off

**Factory setting**

Process value

**Decimal places 1** (decimal places 2 or 3)**Navigation**
 System → Display → Format display → Decimal places 1 (Decimal places 2 or 3)
**Prerequisite**

A measured value is defined in the parameter **Value 1 display** (Value 2 or 3 display).

**Description**

Use this function to select the number of decimal places for the display value. This setting does not affect the accuracy of the device for measuring or calculating the value.

 If **Automatic** is selected, the maximum possible number of decimal places is always shown on the display.

**Options**

- x
- x.x
- x.xx
- x.xxx
- x.xxxx
- Automatic

**Factory setting**

Automatic

# Index

## 0 ... 9

2-wire compensation (parameter) . . . . .	73
4mA value (parameter) . . . . .	76
20mA value (parameter) . . . . .	76

## A

Accessories	
Communication-specific . . . . .	43
Device-specific . . . . .	42
System components . . . . .	44
Actual diag channel n . . . . .	64
Actual diagnostics (submenu) . . . . .	64
Actual diagnostics 1 . . . . .	64
Actual diagnostics n . . . . .	64
Alarm delay (parameter) . . . . .	67
Altitude (parameter) . . . . .	87

## B

Bluetooth (parameter) . . . . .	84
Bluetooth configuration (submenu) . . . . .	84

## C

Cable specification . . . . .	19
Call./v. Dusen coeff. A, B and C (parameter) . . . . .	75
Call./v. Dusen coeff. R0 (parameter) . . . . .	74
CE mark . . . . .	58
Change Bluetooth password (parameter) . . . . .	84
Change password (parameter) . . . . .	83
Confirm new password (parameter) . . . . .	81
Connection type (parameter) . . . . .	73
Current output (submenu) . . . . .	76
Current output simulation (parameter) . . . . .	66
Current trimming 4 mA (parameter) . . . . .	77
Current trimming 20 mA (parameter) . . . . .	78

## D

Damping (parameter) . . . . .	78
Decimal point (parameter) . . . . .	89
Define password (parameter) . . . . .	80
Delete password (parameter) . . . . .	83
Designated use . . . . .	7
Device (submenu) . . . . .	84
Device location (submenu) . . . . .	86
Device management (submenu) . . . . .	79
Device name . . . . .	86
Device reset (parameter) . . . . .	79
Device tag (parameter) . . . . .	79
Device temperature . . . . .	71
Device temperature max. (parameter) . . . . .	70
Device temperature min. (parameter) . . . . .	70
Device variables . . . . .	31
Diagnostic behavior (parameter) . . . . .	68
Diagnostic event simulation (parameter) . . . . .	66
Diagnostic events	
Diagnostic behavior . . . . .	38
Overview . . . . .	39
Status signals . . . . .	38

Diagnostic list (submenu) . . . . .	64
Diagnostic settings (submenu) . . . . .	67
Display (submenu) . . . . .	88
Display interval (parameter) . . . . .	88
Disposal . . . . .	42
Document	
Function . . . . .	4
Document function . . . . .	4

## E

Enter password (parameter) . . . . .	82
Event logbook (submenu) . . . . .	65

## F

Failure current (parameter) . . . . .	77
Failure mode (parameter) . . . . .	76
FieldCare	
Function scope . . . . .	27
User interface . . . . .	29
Firmware version . . . . .	85
Format display (parameter) . . . . .	88

## H

Hardware revision . . . . .	85
-----------------------------	----

## I

Information (submenu) . . . . .	84
---------------------------------	----

## L

Latitude (parameter) . . . . .	86
Limit corrosion detection (parameter) . . . . .	68
Linearization (submenu) . . . . .	74
Location description (parameter) . . . . .	87
Location method (parameter) . . . . .	87
Locking status . . . . .	79
Logout (parameter) . . . . .	83
Longitude (parameter) . . . . .	86

## M

Mains filter (parameter) . . . . .	79
Manufacturer (parameter) . . . . .	86
Measured values (submenu) . . . . .	70
Min/max values (submenu) . . . . .	69
Mounting location	
DIN rail (DIN rail clip) . . . . .	11
Field housing . . . . .	11
Terminal head, flat face as per DIN 43729 . . . . .	11

## N

Nameplate . . . . .	8
New password (parameter) . . . . .	81

## O

Operating time . . . . .	64
Operation options	
Local operation . . . . .	22
Operating tool . . . . .	22

Overview . . . . .	22	TV . . . . .	72
SmartBlue app . . . . .	29	<b>U</b>	
Order code . . . . .	85	Unit (parameter) . . . . .	72
Order code (parameter) . . . . .	85	User management (submenu) . . . . .	80
Other standards and guidelines . . . . .	60	<b>V</b>	
Output current . . . . .	71	Value current output (parameter) . . . . .	66
<b>P</b>		Value display (parameter) . . . . .	89
Percent of range . . . . .	71	Version data for the device . . . . .	31
Polynomial coeff. A, B (parameter) . . . . .	75	<b>W</b>	
Polynomial coeff. RO (parameter) . . . . .	75	Wire without wire end ferrule . . . . .	19
Previous diag n channel . . . . .	65		
Previous diagnostics . . . . .	65		
Process unit tag (parameter) . . . . .	87		
Properties (submenu) . . . . .	67		
PV . . . . .	71		
<b>Q</b>			
QV . . . . .	72		
<b>R</b>			
Recover password (parameter) . . . . .	82		
Reference junction (parameter) . . . . .	73		
Reset device temp. min/max values (parameter) . . . . .	70		
Reset sensor min/max values (parameter) . . . . .	70		
Return . . . . .	42		
RJ preset value (parameter) . . . . .	74		
<b>S</b>			
Sensor (submenu) . . . . .	72		
Sensor line resistance (parameter) . . . . .	68		
Sensor lower limit (parameter) . . . . .	75		
Sensor max. value (parameter) . . . . .	69		
Sensor min value (parameter) . . . . .	69		
Sensor offset (parameter) . . . . .	74		
Sensor raw value . . . . .	71		
Sensor simulation (parameter) . . . . .	67		
Sensor simulation value (parameter) . . . . .	67		
Sensor type (parameter) . . . . .	72		
Sensor upper limit (parameter) . . . . .	76		
Sensor value . . . . .	70		
Serial number . . . . .	84		
Simulation (submenu) . . . . .	66		
Solid wire . . . . .	19		
Status password entry (parameter) . . . . .	81, 82, 83		
Status signal (parameter) . . . . .	69		
Structure of the operating menu . . . . .	25		
SV . . . . .	71		
System (menu) . . . . .	64, 70, 79		
System components . . . . .	44		
<b>T</b>			
Terminal assignment . . . . .	18		
Thermocouple diagnostic (parameter) . . . . .	68		
Time stamp n . . . . .	65, 66		
Troubleshooting			
Application error with RTD sensor connection . . . . .	37		
Application error with TC sensor connection . . . . .	37		
Checking the display . . . . .	36		
General errors . . . . .	36		







[www.addresses.endress.com](http://www.addresses.endress.com)

---