LOW VOLTAGE AC DRIVES

ABB industrial drives

ACS880, drive modules
0.55 to 3200 kW



—

**Reliability, performance and safety.
ACS880 series.**

ABB industrial drives

ACS880, drive modules

004 – 017	THE ALL-COMPATIBLE ACS880 DRIVE SERIES
006 – 007	SIMPLIFY YOUR WORLD WITHOUT LIMITING YOUR POSSIBILITIES
008	OPTIMIZED FOR CABINET ASSEMBLY
009	EASE OF ENGINEERING AND USE
010	VIRTUAL COMMISSIONING
011	SMARTER SOLUTIONS WITH DRIVE-BASED FUNCTIONAL SAFETY
012	COMPREHENSIVE CONNECTIVITY
013	MINIMIZED DOWNTIME
014	GLOBAL COMPATIBILITY WITH VARIOUS DEMANDS
015	PREMIUM CONTROL AND PROGRAMMABILITY
016 – 017	APPLICATION- AND INDUSTRY-SPECIFIC SOLUTIONS
018	HOW TO SELECT A DRIVE
019	TECHNICAL DATA
020 – 023	WALL-MOUNTED SINGLE DRIVE MODULES, ACS880-01+P940/P944
024 – 031	SINGLE DRIVE MODULES, ACS880-04/04F, ACS880-04XT/04FXT HIGH POWER SINGLE DRIVE MODULE PACKAGES, ACS880-04
032 – 037	REGENERATIVE DRIVE MODULES, ACS880-11+P940, ACS880-14
038 – 043	ULTRA-LOW HARMONIC DRIVE MODULES, ACS880-31+P940, ACS880-34
044 – 058	AIR-COOLED MULTIDRIVE MODULES, ACS880-x04 LIQUID-COOLED MULTIDRIVE MODULES, ACS880-x04LC, ACS880-1007LC/1604LC
059 – 063	DIMENSIONS
064 – 065	STANDARD INTERFACE AND EXTENSIONS FOR PLUG-IN CONNECTIVITY
066 – 090	OPTIONS
066	CONTROL PANEL OPTIONS
067	ABB ABILITY™ SMARTPHONE APPS
068	CONNECTIVITY TO AUTOMATION SYSTEMS
069	FEEDBACK INTERFACE AND DDCS COMMUNICATION OPTIONS
070	REMOTE MONITORING OPTIONS
071	PC TOOL OPTIONS
072 – 073	SAFETY OPTIONS
074 – 075	EMC – ELECTROMAGNETIC COMPATIBILITY
076 – 079	SINE FILTERS
080 – 087	BRAKE OPTIONS
088 – 090	DU/DT FILTERS
091	ABB AUTOMATION PRODUCTS
092 – 093	CHOOSE THE RIGHT MOTOR FOR YOUR APPLICATION
094 – 097	ABB DRIVE SERVICES
094 – 095	KEEP YOUR PROCESS RUNNING
096 – 097	ABB ABILITY™ DIGITAL POWERTRAIN
098 – 105	SUMMARY OF FEATURES AND OPTIONS

The all-compatible ACS880 series

Reliability and flexibility

The ACS880 is an all-compatible ABB industrial drive, offered in a range of wall-mounted drives, drive modules and cabinet-built drives.

ABB's all-compatible drives are designed to provide customers across industries and applications with unprecedented levels of compatibility and flexibility. Our ACS880 drive modules are optimized for panel building. They are customized to meet the particular needs of specific industries, such as oil and gas, mining, metals, chemicals, cement, power plants, material handling, pulp and paper, sawmills, marine, water and wastewater, food and beverage, and automotive. They can control a wide range of applications, including cranes, extruders, winches, winders, conveyors, mixers, compressors, centrifuges, test benches, elevators, extruders, pumps and fans.

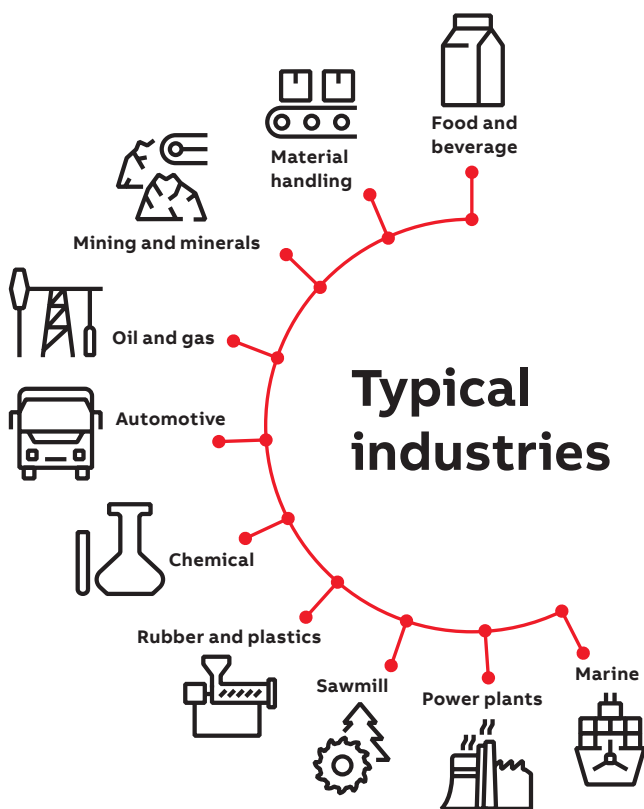

High quality

Reliability and consistent high quality

ACS880 drives are designed for customers who value high quality and robustness in their applications. They have features such as coated boards, making the ACS880 suitable for harsh conditions. Additionally, every ACS880 drive is factory-tested at full load to ensure maximum reliability. The tests include performance and all protective functions.

High performance, safety and configurability

The ACS880 offers the highest level of performance. The drives are equipped with ABB's signature direct torque control (DTC), which provides precise speed and torque control for all applications and supports virtually any type of motor.

Extensive ACS880 offering includes wall-mounted drives, drive modules and cabinet-built drives, as well as low harmonic and regenerative variants.

The ACS880 has all the essential features built-in reducing the time required for engineering, installation and commissioning. A wide range of options are also available to optimize the drive for different requirements, including certified, integrated safety features.



Simplify your world without limiting your possibilities

The ACS880 industrial drive modules are designed for cabinet installation, with features such as optimized location of the power terminals and wheels for easy maneuvering. A wide selection of module variants and options, as well as extensive programming and connectivity possibilities, make the ACS880 suitable for various different requirements and applications.



Optimized for cabinet assembly

- Flexible mounting directions and product configurations
- Side-by-side mounting
- Power terminal locations designed for optimal and compact cabinet layout
- High power modules with wheels for easy maneuvering
- Possibility for flange (push through) mounting
- Mechanical kits for easy cabinet assembly

See page 08



Ease of engineering and use

- All-compatible ACS880 drives share the same easy-to-use user interface
- Multilingual control panel with clear display
- Graphical PC tools for engineering, commissioning and maintenance
- Minimized engineering and installation effort with integrated features and components
- Extensive selection of support material and tools for engineering
- Virtual commissioning

See page 09 – 10



Smarter solutions with drive-based functional safety

- Safe torque off built-in as standard
- Optional safety modules for extended safety functions
- Encoderless safe speed detection
- Highest level of machinery safety, SIL 3 / PL e
- TÜV certified

See page 11



Comprehensive connectivity

- Communication with all major automation networks
- Remote monitoring
- Mobile connectivity
- Integration tools for various PLCs

See page 12



Nine-year maintenance interval



Minimized downtime

- Robust, long lifetime design for maximum reliability
- Coated circuit boards for harsh conditions
- Removable memory unit for fast drive replacement
- Each drive factory-tested at full load
- Nine-year maintenance interval
- Worldwide service and support
- Advanced features for analyzing and resolving issues

See page 13

Global compatibility with various demands

- Global product approvals, e.g. CE, UL, cUL, CSA, marine certifications, ATEX
- Support for various motor types
- Low harmonic content
- Possibility for regeneration

See page 14

Premium control and programmability

- Direct torque control (DTC) for precise control
- Speed, torque and position control as well as synchronizing
- Extensive parameter-based programming
- Adaptive programming as standard
- Drive-based PLC programmability (IEC 61131-3) for fully customized solutions

See page 15

Application- and industry specific solutions

- Ready-made optimized solutions for various applications and industries

See page 16 – 17

Optimized for cabinet assembly

Optimized mechanical design for cabinet assembly

ACS880 drive modules have been optimized for assembly into the customer's own cabinets to ensure high quality and compact installation at minimal cost. High power modules have wheels for easy maneuvering, and the power terminal locations have been designed for optimal and compact cabinet layout. Side-by-side mounting reduces the required cabinet space.

For harsh environments, flange mounting (push through) with IP55 back side protection is offered for complete drive modules. In flange mounting, the control electronics are separated from the cooling airflow for better thermal management and higher reliability.

Flexible mounting and cabling directions enable adaptation to various cabinet enclosures. All the complete ACS880 drive modules have IP20 enclosure class to minimize engineering and assembly effort, as well as to reduce the total cost and ensure a safe ready-made cabinet.

Support for cabinet assembly

A large variety of support material is available for making cabinet assembly, planning and implementation as straightforward and rapid as possible. Cabinet assembly accessories help shorten engineering and assembly time, and help to reduce the risk of errors.

A wide selection of both mechanical and electrical installation accessories are offered for high power modules. These accessories are available giving full design to install the modules into customer enclosures. Alternatively, ABB authorized and registered system integrators and panel builders can offer their assistance.



Ease of engineering and use

All-compatible user interface saves commissioning and learning time

The ACS880 is part of ABB's all-compatible drives portfolio. Other drives in this portfolio are the ACS380, ACS480 and ACS580.

These drives share the same easy-to-use PC tools and multilingual control panels. To further enhance the user experience, they also have the same parameter structure, which saves time on commissioning and learning.

The drives also share the same communication options, simplifying the use of drives and spare parts handling.

Simplicity at your fingertips as standard

The control panel's assistants help you to set up the drive quickly and effectively. The intuitive, high-contrast, high-resolution display offers easy navigation in multiple languages.

The PC tool for commissioning and configuration provides extensive drive monitoring capabilities and quick access to drive settings, as well as features like a graphical interface for configuring safety functions, visual control diagrams, and direct links to user manuals.

Built-in features simplify ordering and installation

All ACS880 drives have a choke for harmonic filtering, a Modbus RTU fieldbus interface, and safe torque off functionality as standard. Other built-in features, standard or optional, include EMC filters, brake choppers, du/dt filters, low harmonic or regenerative functionality and various I/O extensions, communication protocol adapters, and functional safety modules.

The built-in features shorten engineering and installation time as well as reduce the risk of errors. As result, the total cost is lower and the whole drive system is more compact.

Engineering support

ABB provides an extensive selection of support material and tools to help in engineering, such as:

- Dimensioning tools, e.g. DriveSize
- Step by step installation instructions
- E-learning
- Safety circuit design tools
- EPLAN P8 macros
- Selection tool for choosing external components, e.g. fuses and circuit breakers
- Dimensional (2D and 3D) and electrical drawings
- Application guides
- Drive installation and configuration videos

These tools and support from our experts ensure that the drive system can be set up easily and reliably.

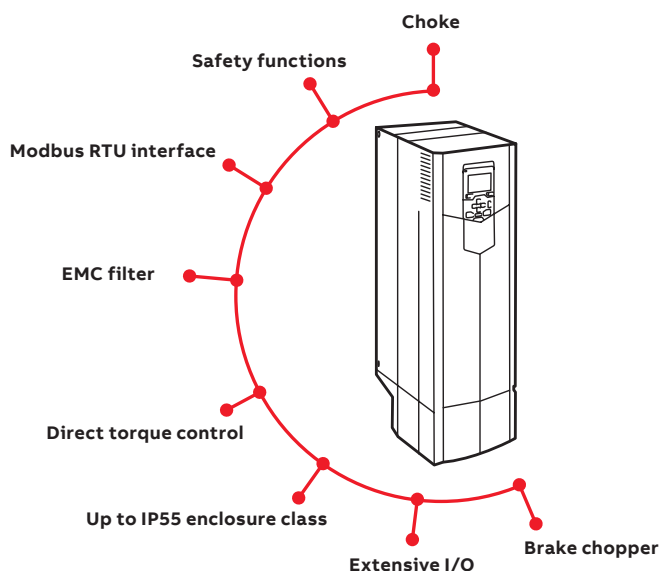

DriveSize dimensioning tool for selecting the optimal drive

DriveSize is designed to help select the optimal drive, motor and transformer for the application. Based on data supplied by the user, the tool calculates and suggests which drive and motors to use.

DriveSize is a free software and can be used either online or downloaded for PC from <https://new.abb.com/drives/software-tools/drivesize>.

Virtual commissioning

Virtual engineering and commissioning allow machine builders and system integrators to develop and simulate entire industrial processing lines and machines, including ABB drives, without actually running the hardware. This gives valuable benefits in the phases of designing, commissioning and operating machines.



Design safely and efficiently

Engineers can start configuring and programming drives well before receiving them from ABB production line, since the same software tools like Drive Composer Pro can be used with virtual and real drives. Virtualization can also cover the kinematical and physical behavior of the machine and the overriding automation. Virtual drives can also be used with the

ABB Robot Studio tool and ABB Automation Builder programming tools to build more complete virtual machines and processing lines.

After deploying the virtual machine in use on-site, any future improvements can be virtually tested before implementing them in the process. This all supports safety and quality in the engineering process.

- Find and solve potential problems earlier
- Save time and money due to faster drive commissioning
- Assist the dimensioning and energy optimization of electromechanical drive systems

Benefits

Throughout the value chain from sales, marketing, and training to field engineering and product development, virtual commissioning makes drive applications more easily understood and helps to:

- Design, test and learn drive applications virtually with the same software tools as for the actual hardware
- Train users and engineers with application simulation
- Tune up drive parameters easily off-site before going into more demanding on-site testing

—
Save time, reduce risk, and increase engineering productivity

Smarter solutions with drive-based functional safety

Maximized safety and conformity

The safe torque off (STO) safety function comes integrated into ACS880 drives. Optional safety functions modules provide an easy way to extend safety functions. These plug-in modules are installed and cabled inside the drive, enabling safety functions and diagnostics in one compact and reliable module. The safety functions are certified by TÜV Nord and comply with the highest performance requirements in machinery safety – SIL 3 / PL e *).

Increased productivity by doing things smarter

Safety functions help to minimize unnecessary downtime by keeping the application in control at all times. Safely-limited speed (SLS), for example, keeps the process running at a safe speed instead of stopping it.

Flexibility and ease of use

The safety functionality can be scaled to your needs. From STO wired to an emergency stop push button, to a complete safety system with PROFIsafe and a safety PLC, e.g. the AC500-S.

Configuring the safety functions module is easy thanks to the graphical user interface of the Drive Composer pro PC tool.

Available safety functionality

The following safety functions are supported:

- Safe torque off (STO)
- Safe stop 1 (SS1-t and SS1-r)
- Safe stop emergency (SSE)
- Safe brake control (SBC)
- Safely-limited speed (SLS)
- Safe maximum speed (SMS)
- Prevention of unexpected startup (POUS)
- Safe direction (SDI)
- Safe speed monitor (SSM)
- Safe motor temperature (SMT)

Integrated safety simplifies configuration

Safety for explosive atmospheres

ACS880 and ABB Ex motors have been certified as a package providing a safe, proven solution for explosive atmospheres. ACS880 safety options for ATEX environments:

- ATEX-approved thermistor protection module
- ATEX-approved safe torque off

TÜV-certified safety design tool

The FSDT-01 functional safety design tool can be used to design complete safety circuits. With this tool it is possible to define required safety integrity (SIL) / performance level (PL) for safety functions, verify achieved safety level and generate design reports.

*) SIL 2 / PL c for SMT, safe motor temperature.



Comprehensive connectivity

Communication with all major automation networks

ACS880 drives come with Modbus RTU fieldbus interface and drive-to-drive communication link as standard.

Plug-in connectivity adapters enable communication with all major industrial automation networks.

The drives support advanced communication features:

- Redundant communication
- PROFIsafe
- Functional safety over fieldbus
- Support for multiple protocols simultaneously
- Shared Ethernet connection for automation communication and Drive Composer PC tool – all communication via the same cable

To minimize connectivity-related risks, cybersecurity is a built-in, integral part of the ACS880.

To simplify ACS880's connectivity to automation systems, ABB offers support tools for seamless integration with PLCs from ABB and several other manufacturers.

Remote monitoring

With a built-in web server and standalone data logger, the NETA-21 remote monitoring tool enables secure worldwide access to your drives.

Drive data can also be collected via a 3G mobile connection with the RMDE reliability monitoring device.

Better connectivity and user experience



Mobile connectivity

The drive has a Bluetooth panel enabling easy connection to mobile devices.

ABB offers several smartphone applications, like Drivetune and Drivebase, to ease and enhance the use of ABB drives. These tools provide a user-friendly and easy-to-use approach for commissioning, servicing and using ABB drives.

Drive mobile apps

- Full access to parameters
- Backup and restore functionality
- Access to drive data and service history
- Possibility to share configuration files via e-mail or Bluetooth
- Easy support package creation for faster remote support

Minimized downtime

Robust, long life time design

The ACS880 is designed to last for a long time, even in harsh conditions. The benefits include a nine-year maintenance interval and good tolerance for vibrations and contamination.

Several design features make the ACS880 a safe choice:

- Coated circuit boards
- Minimized airflow through the control board section
- Designed for ambient temperatures up to 55 °C
- Advanced protections – e.g. faster and more accurate IGBT protection using a thermal model

Each ACS880 drive unit is tested in the factory at full load to ensure maximum reliability. Continuous quality improvements are made based on the results of accelerated lifetime tests.

Removable memory unit

The memory unit stores the drive software and settings, including motor data. This unit can be switched from one drive to another, allowing simple and rapid drive replacement without any special equipment, software loading, parameter settings, or other adjustments in the drive or automation system. It also eliminates the risk of software incompatibility. The new drive is ready to run as soon as the memory unit is plugged in.

Nine-year maintenance interval

Advanced features for analyzing and resolving issues

The ACS880 has timers and counters that can be configured to remind you when the drive or process equipment needs maintenance.



Accurate and reliable diagnostic information is available for warning and fault messages. Help texts give detailed information about the warning or fault. Data loggers store critical values before and during an event, such as a fault. The real-time clock allows you to see the exact times of events.

For faster remote support, all relevant drive data and changed parameters can be saved in a single file package that you can easily create with the PC tool or by creating a QR code with the control panel.

Global support

For true global coverage, ABB offers worldwide support via its extensive pre- and after-sales network, structured to make sure that you have the experts you need close by, locally and globally. See pages 94-97.

Global compatibility with various demands

Global product approvals

The ACS880 is a global product and has all the major global approvals, such as CE, UL, cUL, EAC, RCM and TÜV. Industry-specific approval, like different kinds of marine approval, ATEX and SEMI F47 are available either as standard or as an option.

Support for different motor types

The ACS880 provides reliable control for various motors, such as squirrel cage, high-torque or servo-type permanent magnet, synchronous reluctance (SynRM), submersible and high-speed motors. Practically any encoder type is supported.

Regardless of the motor type, drive commissioning is easy, with no need for laborious manual tuning.

Low harmonic content

All ACS880 drives have a choke for harmonic reduction. If lower harmonic content is needed, an ultra-low harmonic variant is available. It produces exceptionally low harmonic content and meets the requirements of harmonics recommendations like IEEE519, IEC61000-3-12 and G5/4.

Regeneration of energy

The ACS880 offers a number of solutions for applications where electrical braking is needed. As standard, ACS880 drives have a flux braking feature that provides greater deceleration by increasing the motor flux. If this is not sufficient, the internal brake chopper can be used together with a brake resistor.

The most advanced solution is the ACS880 regenerative drive variant, which allows full, continuous braking, providing the possibility for remarkable energy savings.

ACS880 also supports common DC bus configurations, where the braking energy from one load can be utilized by other loads.



Premium control and programmability

Direct torque control (DTC)

ABB's state of the art motor control technology provides precise speed and torque control, with or without an encoder, even close to zero speed. DTC provides reliable starts and rapid reactions to load or network changes, and ensures smooth and continuous operation. DTC provides optimal control, even with sine filters.

The energy optimizer feature maximizes motor efficiency by ensuring maximum torque per ampere, reducing the power drawn from the supply.

Position control and synchronizing

Position control allows to meet motion systems demands without the need of an external position controller. The ready-made motion functions can be easily configured by parameters. For optimized solution for your application, the functions can be modified and extended by IEC 61131 programming using PLCOpen motion blocks.

Additional features, such as built-in synchronized drive to drive link and possibility for encoderless positioning, make ACS880 position control ideal for any axis.

Drive programming

To meet your specific application needs, you can customize your ACS880 with an extensive range of user-definable software settings (parameters) and adaptive programming. This makes fine-tuning the ready-made application control program functionalities easy. For further customization, drive application programming based on IEC 61131 standard is available for full PLC programmability. IEC programming uses the same programming environment as ABB PLCs. It is also easy to integrate the ACS880 with other components, such as PLCs and HMIs.

Adaptive programming is

an easy to use dynamic programming which allows flexible adjustments to the ACS880 software.

IEC programming

based on IEC 61131 standard for full scale PLC programmability is available as an option.

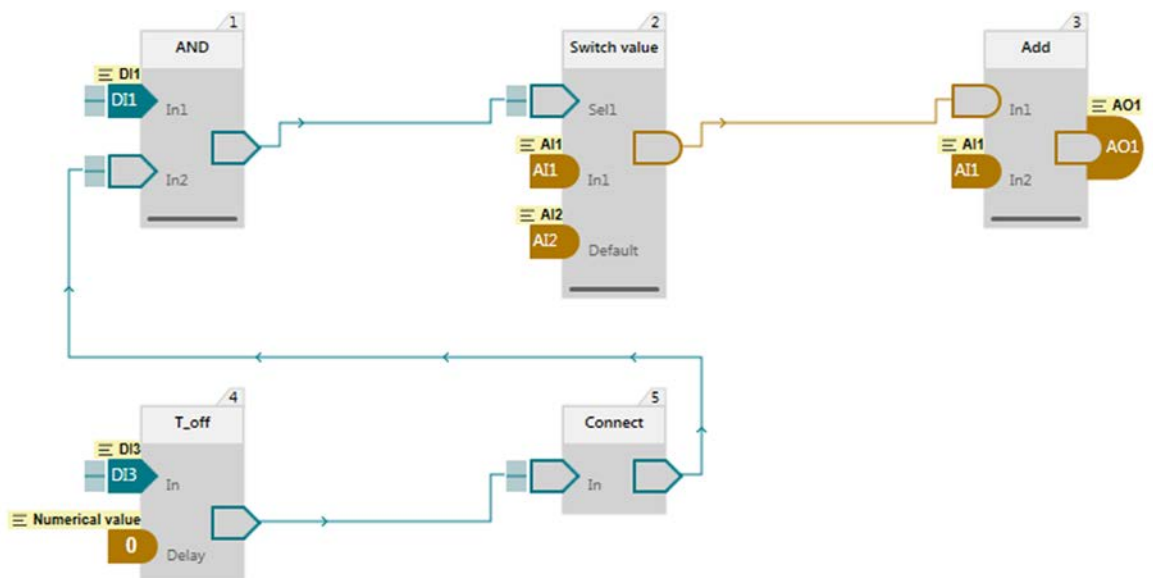

Application- and industry-specific solutions

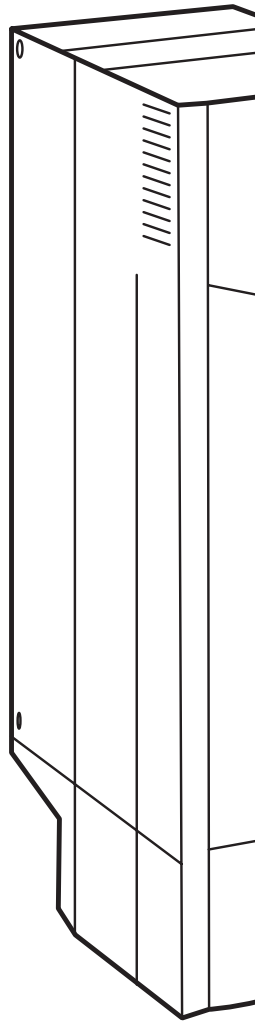
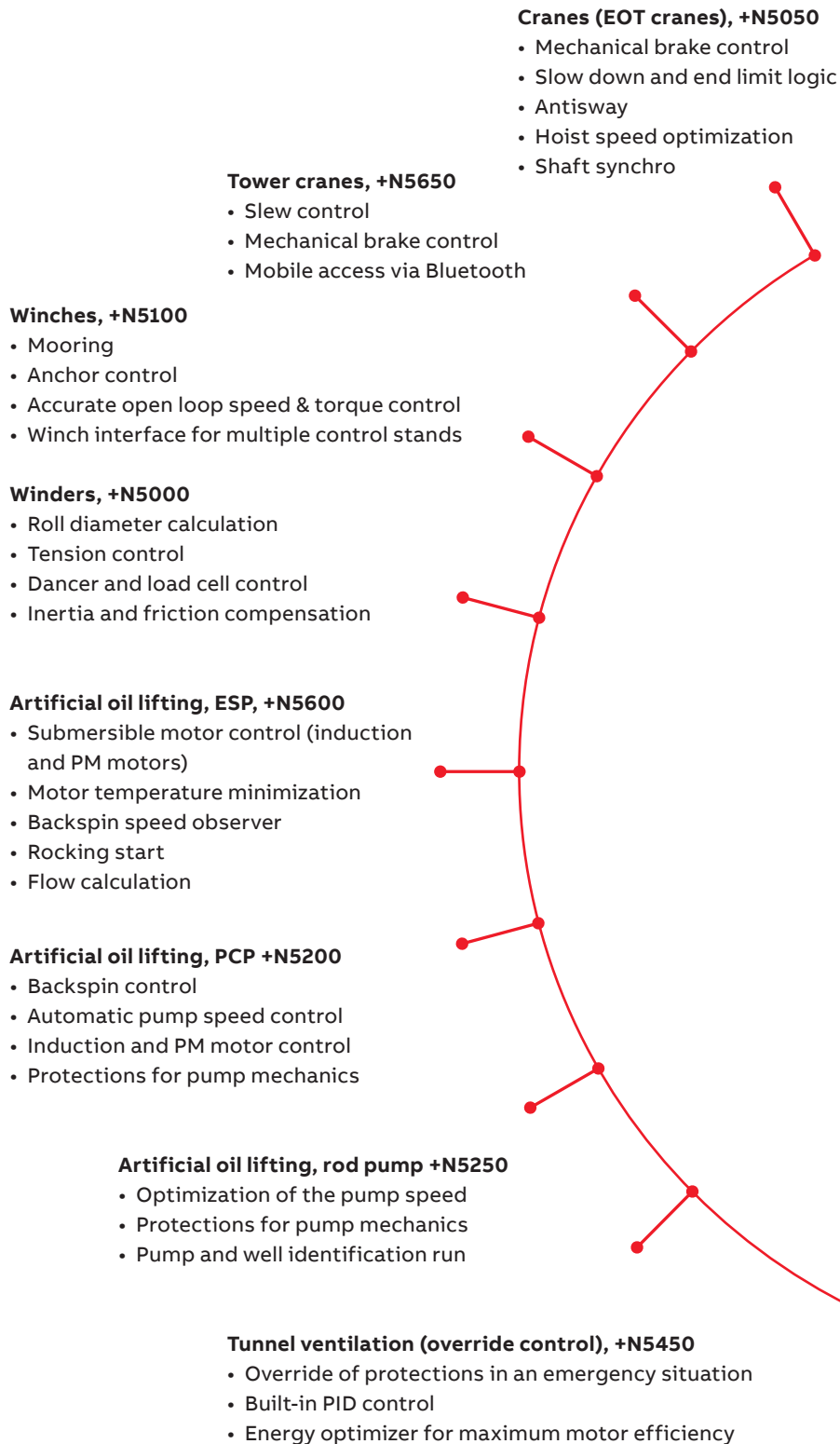

By working closely with customers over many years, ABB has developed application control programs and specific software features for specific applications and industries. This results in programs and features that include lessons learned from many customers, and that are designed to give you the flexibility to adapt the programs to your specific needs.

Advantages:

- Enhanced application usability
- Lower energy consumption
- Increased safety
- Reduced need for PLCs
- Protected machinery
- Optimized application productivity
- Optimized time usage and lower operational costs

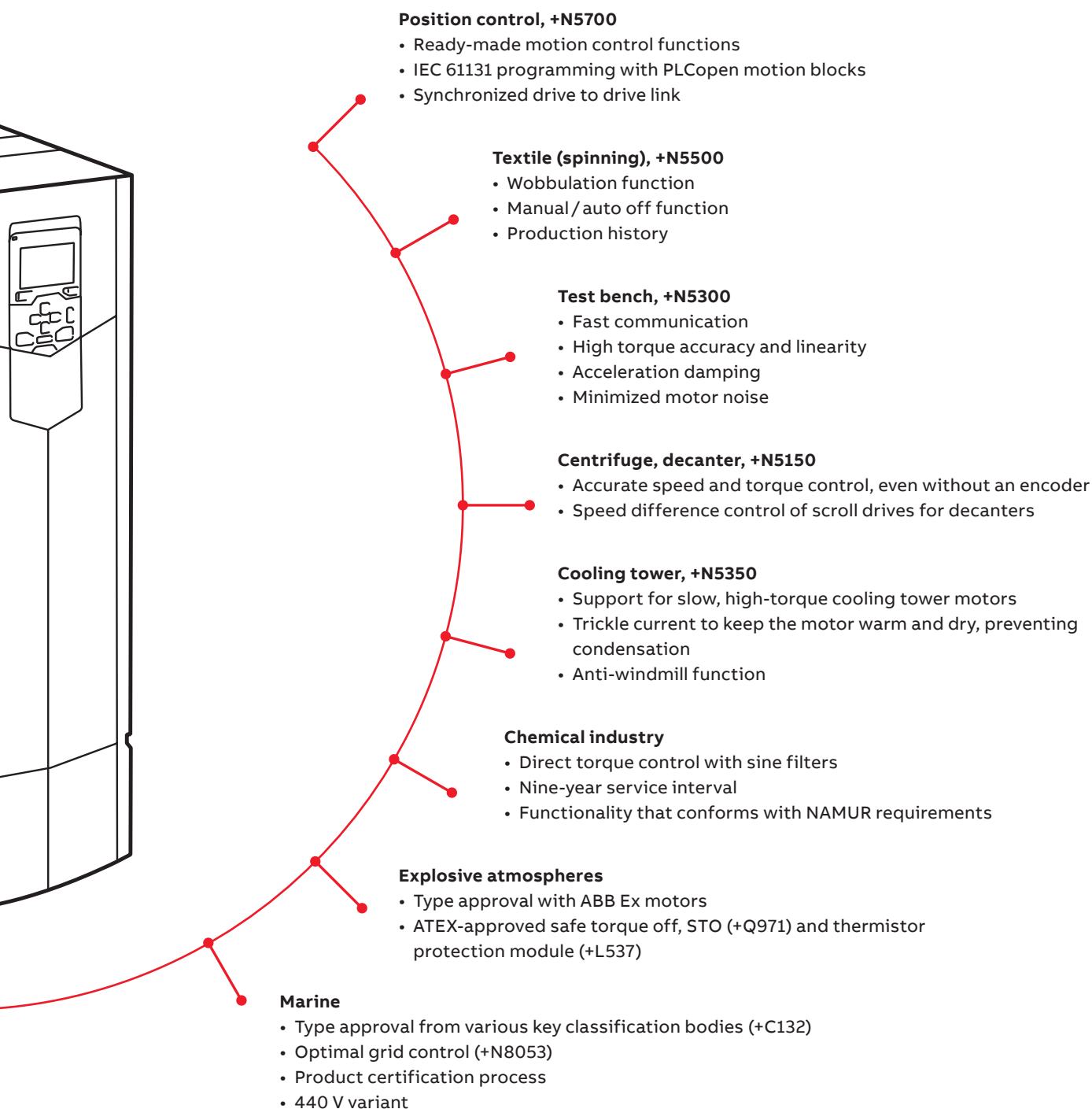

How to select a drive

The right drive is extremely easy to select. The following instructions show you how to order the right drive for your application.

Start by identifying your supply voltage and select the related rating table. Or use ABB's DriveSize dimensioning tool.

Select your drive's order code (drive type) from the rating table based on the load current, or, if it is unknown, select the drive based on your motor's power and current ratings.

RATINGS, TYPES AND VOLTAGES: ACS880-01P940/P944

Ratings, types and voltages ACS880-01+P940/P944

U_N 230 V range 230 to 240 V. The power ratings are valid at nominal voltage 230 V (0.95 to 0.94 kW).

Drive type	Frame size	Nominal ratings		Light overload use		Motor duty use	Motor level	Heat dissipation	AP flow		
		I _N (A)	P _N (kW)	I _L (A)	P _L (kW)						
ACS880-01-04A2-2	45	4.6	6.1	5.75	4.4	5.75	1.7	0.55	46	73	44
ACS880-01-04A2-3	45	4.6	7.8	1.1	4.4	5.75	1.7	0.75	46	84	44
ACS880-01-04A2-4	45	15	11.7	1.1	1.1	1.5	6.6	1.1	46	159	44
ACS880-01-04A2-5	45	15.6	15.8	2.2	10.1	2.2	7.5	1.5	46	172	44
ACS880-01-04A2-6	45	28.8	18.0	4.0	16.0	4.0	10.6	2.2	51	232	88
ACS880-01-04A2-7	45	28.8	28.6	5.5	21.1	5.5	16.8	4	51	287	88
ACS880-01-04A2-8	45	32.0	41	7.5	29.3	7.5	24.3	4.5	57	427	134
ACS880-01-04A2-9	45	46	64	11	44	11	38	7.5	62	650	134
ACS880-01-05A2-1	46	65	70	15	58	15	45	5.1	62	620	280
ACS880-01-05A2-2	46	75	104	18.5	71	18.5	61	15	62	680	280
ACS880-01-05A2-3	46	87	122	22	83	22	72	18.5	62	730	280
ACS880-01-05A2-4	46	115	148	30	109	30	87	22	67	840	450
ACS880-01-05A2-5	46	145	178	37	138	37	105	30	67	940	450
ACS880-01-05A2-6	46	170	217	45	164	45	140	37	67	1260	450
ACS880-01-05A2-7	46	206	287	55	196	55	169	45	67	1500	650
ACS880-01-05A2-8	46	278	362	75	260	75	233	65	65	2100	650

U_N 400 V range 380 to 415 V. The power ratings are valid at nominal voltage 400 V (0.95 to 0.94 kW).

Drive type	Frame size	Nominal ratings		Light overload use		Motor duty use	Motor level	Heat dissipation	AP flow		
		I _N (A)	P _N (kW)	I _L (A)	P _L (kW)						
ACS880-01-04A3-1	45	2.4	3.1	0.75	2.3	0.75	1.8	0.55	46	50	44
ACS880-01-04A3-2	45	3.3	4.1	1.1	3.1	1.1	2.4	0.75	46	60	44
ACS880-01-04A3-3	45	4.0	5.6	1.5	3.8	1.5	3.1	1.1	46	52	44
ACS880-01-04A3-4	45	5.6	6.8	2.2	5.3	2.2	4.0	1.5	46	71	44
ACS880-01-04A3-5	45	8.0	9.5	3	7.6	3	5.6	2.2	46	84	44
ACS880-01-04A3-6	45	10	12.7	4	9.5	4	8.0	3	46	102	44
ACS880-01-04A3-7	45	12.5	16	5.5	11	5.5	10	4	46	122	44
ACS880-01-04A3-8	45	17	21	7.5	16	7.5	13.5	5.1	57	232	88
ACS880-01-04A3-9	45	25	29	11	24	11	17	7.5	60	287	88
ACS880-01-05A3-1	46	45	64	22	43	22	38	18.5	62	667	134
ACS880-01-05A3-2	46	62	76	30	58	30	45	22	62	867	280
ACS880-01-05A3-3	46	72	94	37	68	37	61	30	62	1117	280
ACS880-01-05A3-4	46	87	107	45	81	45	72	37	67	1260	450
ACS880-01-05A3-5	46	105	148	55	100	55	87	45	67	1450	450
ACS880-01-05A3-6	46	145	178	75	138	75	105	65	67	1840	450
ACS880-01-05A3-7	46	169	217	95	160	95	140	75	67	2160	650
ACS880-01-05A3-8	46	206	287	120	196	120	169	95	67	2500	650
ACS880-01-05A3-9	46	288	362	150	260	150	233	120	65	3300	650

U_N 480 V range 380 to 415 V. The power ratings are valid at nominal voltage 480 V (0.95 to 0.94 kW).

Drive type	Frame size	Nominal ratings		Light overload use		Motor duty use	Motor level	Heat dissipation	AP flow		
		I _N (A)	P _N (kW)	I _L (A)	P _L (kW)						
ACS880-01-04A3-1	45	2.4	3.1	0.75	2.3	0.75	1.8	0.55	46	50	44
ACS880-01-04A3-2	45	3.3	4.1	1.1	3.1	1.1	2.4	0.75	46	60	44
ACS880-01-04A3-3	45	4.0	5.6	1.5	3.8	1.5	3.1	1.1	46	52	44
ACS880-01-04A3-4	45	5.6	6.8	2.2	5.3	2.2	4.0	1.5	46	71	44
ACS880-01-04A3-5	45	8.0	9.5	3	7.6	3	5.6	2.2	46	84	44
ACS880-01-04A3-6	45	10	12.7	4	9.5	4	8.0	3	46	102	44
ACS880-01-04A3-7	45	12.5	16	5.5	11	5.5	10	4	46	122	44
ACS880-01-05A3-1	46	45	64	22	43	22	38	18.5	62	667	134
ACS880-01-05A3-2	46	62	76	30	58	30	45	22	62	867	280
ACS880-01-05A3-3	46	72	94	37	68	37	61	30	62	1117	280
ACS880-01-05A3-4	46	87	107	45	81	45	72	37	67	1260	450
ACS880-01-05A3-5	46	105	148	55	100	55	87	45	67	1450	450
ACS880-01-05A3-6	46	145	178	75	138	75	105	65	67	1840	450
ACS880-01-05A3-7	46	169	217	95	160	95	140	75	67	2160	650
ACS880-01-05A3-8	46	206	287	120	196	120	169	95	67	2500	650
ACS880-01-05A3-9	46	288	362	150	260	150	233	120	65	3300	650

RATINGS, TYPES AND VOLTAGES: ACS880-01P940/P944

Ratings, types and voltages ACS880-01+P940/P944

U_N 230 V range 230 to 240 V. The power ratings are valid at nominal voltage 230 V (0.95 to 0.94 kW).

Drive type	Frame size	Nominal ratings		Light overload use		Motor duty use	Motor level	Heat dissipation	AP flow		
		I _N (A)	P _N (kW)	I _L (A)	P _L (kW)						
ACS880-01-04A2-2	45	4.6	6.1	5.75	4.4	5.75	1.7	0.55	46	73	44
ACS880-01-04A2-3	45	4.6	7.8	1.1	4.4	5.75	1.7	0.75	46	84	44
ACS880-01-04A2-4	45	15	11.7	1.1	1.1	1.5	6.6	1.1	46	159	44
ACS880-01-04A2-5	45	15.6	15.8	2.2	10.1	2.2	7.5	1.5	46	172	44
ACS880-01-04A2-6	45	28.8	18.0	4.0	16.0	4.0	10.6	2.2	51	232	88
ACS880-01-04A2-7	45	28.8	28.6	5.5	21.1	5.5	16.8	4	51	287	88
ACS880-01-04A2-8	45	32.0	41	7.5	29.3	7.5	24.3	4.5	57	427	134
ACS880-01-04A2-9	45	46	64	11	44	11	38	7.5	62	650	134
ACS880-01-05A2-1	46	65	70	15	58	15	45	5.1	62	620	280
ACS880-01-05A2-2	46	75	104	18.5	71	18.5	61	15	62	680	280
ACS880-01-05A2-3	46	87	122	22	83	22	72	18.5	62	730	280
ACS880-01-05A2-4	46	115	148	30	109	30	87	22	67	840	450
ACS880-01-05A2-5	46	145	178	37	138	37	105	30	67	940	450
ACS880-01-05A2-6	46	170	217	45	164	45	140	37	67	1260	450
ACS880-01-05A2-7	46	206	287	55	196	55	169	45	67	1500	650
ACS880-01-05A2-8	46	278	362	75	260	75	233	65	65	2100	650

U_N 400 V range 380 to 415 V. The power ratings are valid at nominal voltage 400 V (0.95 to 0.94 kW).

Drive type	Frame size	Nominal ratings		Light overload use		Motor duty use	Motor level	Heat dissipation	AP flow		
		I _N (A)	P _N (kW)	I _L (A)	P _L (kW)						
ACS880-01-04A3-1	45	2.4	3.1	0.75	2.3	0.75	1.8	0.55	46	50	44
ACS880-01-04A3-2	45	3.3	4.1	1.1	3.1	1.1	2.4	0.75	46	60	44
ACS880-01-04A3-3	45	4.0	5.6	1.5	3.8	1.5	3.1	1.1	46	52	44
ACS880-01-04A3-4	45	5.6	6.8	2.2	5.3	2.2	4.0	1.5	46	71	44
ACS880-01-04A3-5	45	8.0	9.5	3	7.6	3	5.6	2.2	46	84	44
ACS880-01-04A3-6	45	10	12.7	4	9.5	4	8.0	3	46	102	44
ACS880-01-04A3-7	45	12.5	16	5.5	11	5.5	10	4	46	122	44
ACS880-01-05A3-1	46	45	64	22	43	22	38	18.5	62	667	134
ACS880-01-05A3-2	46	62	76	30	58	30	45	22	62	867	280
ACS880-01-05A3-3	46	72	94	37	68	37	61	30	62	1117	280
ACS880-01-05A3-4	46	87	107	45	81	45	72	37	67	1260	450
ACS880-01-05A3-5	46	105	148	55	100	55	87	45	67	1450	450
ACS880-01-05A3-6	46	145	178	75	138	75	105	65	67	1840	450
ACS880-01-05A3-7	46	169	217	95	160	95	140	75	67	2160	650
ACS880-01-05A3-8	46	206	287	120	196	120	169	95	67	2500	650
ACS880-01-05A3-9	46	288	362	150	260	150	233	120	65	3300	650

U_N 480 V range 380 to 415 V. The power ratings are valid at nominal voltage 480 V (0.95 to 0.94 kW).

Drive type	Frame size	Nominal ratings		Light overload use		Motor duty use	Motor level	Heat dissipation	AP flow		
		I _N (A)	P _N (kW)	I _L (A)	P _L (kW)						
ACS880-01-04A3-1	45	2.4	3.1	0.75	2.3	0.75	1.8	0.55	46	50	44
ACS880-01-04A3-2	45	3.3	4.1	1.1	3.1	1.1	2.4	0.75	46	60	44
ACS880-01-04A3-3	45	4.0	5.6	1.5	3.8	1.5	3.1	1.1	46	52	44
ACS880-01-04A3-4	45	5.6	6.8	2.2	5.3	2.2	4.0	1.5	46	71	44
ACS880-01-04A3-5	45	8.0	9.5	3	7.6	3	5.6	2.2	46	84	44
ACS880-01-04A3-6	45	10	12.7	4	9.5	4	8.0	3	46	102	44
ACS880-01-04A3-7	45	12.5	16	5.5	11	5.5	10	4	46	122	44
ACS880-01-05A3-1	46	45	64	22	43	22	38	18.5	62	667	134
ACS880-01-05A3-2	46	62	76	30	58	30	45	22	62	867	280
ACS880-01-05A3-3	46	72	94	37	68	37	61	30	62	1117	280
ACS880-01-05A3-4	46	87	107	45	81	45	72	37	67	1260	450
ACS880-01-05A3-5	46	105	148	55	100	55	87	45	67	1450	450
ACS880-01-05A3-6	46	145	178	75	138	75	105	65	67	1840	450
ACS880-01-05A3-7	46	169	217	95	160	95	140	75	67	2160	650
ACS880-01-05A3-8	46	206	287	120	196	120	169	95	67	2500	650
ACS880-01-05A3-9	46	288	362								

Technical data

Mains connection	
Voltage and power range	3-phase, U_{N2} 208 to 240 V, +10%/-15% (-01) 3-phase, U_{N3} 380 to 415 V, +10%/-15% (-01, -04, -04F, -11, -31, -14, -34) 3-phase, U_{N5} 380 to 500 V, +10%/-15% (-01, -04, -04F, -11, -31, -14, -34) 3-phase, U_{N7} 525 to 690 V, +10%/-15% (-01, -04, -04F, -14, -34) 3-phase, U_{N3} 380 to 415 V, $\pm 10\%$ (-x04, -x4 ³⁾) 3-phase, U_{N5} 380 to 500 V, $\pm 10\%$ (-x04, -x4 ³⁾) 3-phase, U_{N7} 525 to 690 V, $\pm 10\%$ (-x04, -x04LC, -x4 ³⁾) ACS880-01, -04, -04F, -11, -31, -14, -34, -x4 ³⁾ , -104, -104LC: 0.55 to 3200 kW Diode supply unit (DSU) 55 to 5445 kVA IGBT supply unit (ISU) 5.5 to 3679 kVA Regenerative rectifier unit (RRU) 400 to 4135 kVA
Frequency	50/60 Hz $\pm 5\%$
Power factor	
ACS880-01, -04, -04F	$\cos\varphi = 0.98$ (fundamental) $\cos\varphi = 0.93$ to 0,95 (total)
ACS880-11, -31, -14, -34	$\cos\varphi = 1$ (fundamental)
IGBT supply unit (ISU)	$\cos\varphi = 1$ (fundamental) $\cos\varphi = 0.99$ (total)
Diode supply unit (DSU) and Regenerative rectifier unit (RRU)	$\cos\varphi = 0.98$ (fundamental) $\cos\varphi = 0.93$ to 0.95 (total)
Efficiency (at nominal power)	ACS880-01, -04, -04F, -104, DSU, RRU: 98%. ACS880-11, -31, -14, -34, ISU: 97%
Motor connection	
Voltage	3-phase output voltage 0 to $U_{N2} / U_{N3} / U_{N5} / U_{N7}$
Frequency	0 to ± 598 Hz ¹⁾
Motor control	Direct torque control (DTC)
Torque control	Torque step rise time: Open loop <5 ms with nominal torque Closed loop <5 ms with nominal torque Non-linearity: Open loop $\pm 4\%$ with nominal torque Closed loop $\pm 3\%$ with nominal torque
Speed control	Static accuracy: Open loop 10% of motor nominal slip Closed loop 0.01% of nominal speed Dynamic accuracy: Open loop 0.3 to 0.4% seconds with 100% torque step Closed loop 0.1 to 0.2% seconds with 100% torque step
Product compliance	
CE Low Voltage Directive 2014/35/EU according to EN 61800-5-1:2007 Machinery Directive 2006/42/EC EMC Directive 2014/30/EU ATEX Directive 2014/34/EU, EN 50495 Quality assurance system ISO 9001 and Environmental system ISO 14001 RoHS 2011/65/EU and Delegated Directive (EU) 2015/836 cULus listed according to UL 508C or UL 61800-5-1 and CSA C22.2 No. 274, CSA Certified according to CSA C22.2 No. 274 RCM, EAC ⁴⁾ TÜV Nord certification for functional safety ⁵⁾ ATEX-certified safe disconnection function and thermistor protection function, Ex II (2) GD ⁷⁾ Marine type approvals for -01: ABS, Bureau veritas, CCS, DNV GL, KR, Lloyd's, NK, RINA, RMRS. For other modules, see http://new.abb.com/drives/segments/marine/marine-type-approvals .	
EMC according to EN 61800-3: 2004 + A1: 2012. See page 75.	
1 st environment category C2 included as option (-01, -04, -04F, -x4 ³⁾ , -11 ³⁾ , -31 ³⁾ , -14, -34, -x04).	
2 nd environment category C3 included as standard (-x04, -x04LC, -x4 ³⁾)	
2 nd environment category C3 included as option (-01, -04, -04F, -11, -31, -x4 ^{2) 3)} , -14, -34)	
2 nd environment category C4 included as standard	

Environmental limits	
Ambient temperature	
Transport	-40 to +70 °C
Storage	-40 to +70 °C
Operation area (air-cooled)	-15 to +40 °C as standard (-01, -04, -04F, -11, -31, -14, -34) 0 to +40 °C as standard (-x04, -x4 ³⁾) +40 to +55 °C with derating of 1%/1 °C (-01, -04, -04F, -11, -31, -14, -34) +40 to +50 °C with derating of 1%/1 °C (-x04, -x4 ³⁾)
(liquid-cooled)	0 to +45 °C as standard (-x04LC) +45 to +55 °C with derating of 0,5%/1 °C (-x04LC)
Cooling method	
Air-cooled	Dry clean air
Liquid-cooled	Direct liquid cooling, Antifrogen® L Incoming coolant temperature to module (x04LC): 0 to +40 °C as standard +40 to +45 °C with derating of 2%/1 °C +45 to +50 °C with derating of 2%/1 °C or 6%/1 °C ⁸⁾ Incoming coolant temperature to optional liquid-cooling unit (-1007LC) (fresh water or sea water): 0 to +36 °C as standard +36 to +46 °C with derating of 2%/1 °C
Altitude	
0 to 1,000 m	Without derating
1,000 to 4,000 m	With derating of 1% / 100 m ⁶⁾
Relative humidity	5 to 95%, no condensation allowed
Degree of protection	
IP00	-x4 ³⁾ , -x04, -x04LC
IP20	-01, -04, -04F, -11, -31, -14, -34
Paint color	RAL 9017/9002
Pollution degree	PD 2
Contamination levels	No conductive dust allowed
Storage	IEC 60721-3-1:1997, Class 1C2 (chemical gases), Class 1S2 (solid particles) ^{*)}
Operation	IEC 60721-3-3:2002, Class 3C2 (chemical gases), Class 3S2 (solid particles) ^{*)}
Transportation	IEC 60721-3-2:1997, Class 2C2 or 3C2 (chemical gases), Class 2S2 (solid particles without air inlet filters) ^{*)}
Built-in functional safety. See pages 72 -73.	
For safe torque off (STO) and safety functions module	EN/IEC 61800-5-2, IEC 61508: SIL 3, IEC 61511: SIL 3, EN/IEC 62061: SIL CL 3, EN ISO 13849-1: PL e - TÜV Nord certified ⁵⁾
Safety over fieldbus	PROFIsafe over PROFINET, certified.
*) C = Chemically active substances, *) S = Mechanically active substances	
1) For higher operational output frequencies please contact your local ABB office. Operation above 120 Hz might require type specific derating, please contact your local ABB office. Output filters may limit the output frequency. See product specific hardware manual for details.	
2) Please check availability per drive type	
3) Single drive module packages ACS880-04, -14 and -34 which consist of several modules	
4) EAC directives: TR CU 020/2011 (EMC directive); TR CU 004/2011 (low voltage directive) EAC has replaced GOST R	
5) For available certificates, see http://new.abb.com/drives/functional-safety	
6) Derating reduced by lower than 40 °C ambient temperature	
7) Safe disconnection function (+Q971), thermistor protection function (+L537)	
8) See product specific hardware manual for detailed derating rules.	
9) Please check availability for -11 and -31 frame size R8.	

Wall-mounted single drive modules

ACS880-01+P940/P944



- 01 ACS880-01+P940 with flange mounting
- 02 ACS880-01+P940
- 03 ACS880-01+P944

Easy engineering and cabinet assembly
ACS880-01 drives have all the essential features built-in. These features include as standard a choke for harmonic filtering as well as options such as a brake chopper, EMC filter and communication protocol adapter, functional safety and I/O extension modules. The all built-in design simplifies engineering and installation reducing the total cost and risk of errors. One complete package, together with side-by-side mounting, reduces the required cabinet space.

Flange (push through) mounting with IP55 heat sink is available making ACS880-01 ideal for harsh environments. In flange mounting the control electronics are separated from the cooling airflow for better thermal management.

Wall-mounted single drive modules, ACS880-01+P940/P944

- Power ratings: 0.55 to 250 kW
- Enclosure classes: IP20, in flange mounting heat sink side IP55 for dusty and wet environments

Main options:

- Flange mounting
- C2 and C3 EMC filters, see page 74
- Brake chopper (as standard in frames R1 to R4), see page 80
- Brake resistor, see page 80
- Marine type approval from various key classification bodies
- I/O extension modules, see page 68
- Communication protocol adapters, see page 68
- Speed feedback interfaces, see page 69
- Functional safety modules, see page 72
- Remote monitoring options, see page 70
- Application specific software, see page 16
- Du/dt filters, see page 88
- Sine filters, see page 76

The drives have an extensive selection of built-in features and options. See page 98.

Highlights

- Robust and reliable design with IP20 enclosure class
- Compact, single package with all the essential features built-in
- Side-by-side mounting
- Possibility for flange (push through) mounting
- Incoming air temperature measurement for protecting the drive from different temperature related failures
- Optional marine type approved version
- Tools and documents (like EPLAN macros, line apparatus selection tool) to support engineering

Ratings, types and voltages

ACS880-01+P940/P944

$U_N = 230$ V (range 208 to 240 V). The power ratings are valid at nominal voltage 230 V (0.55 to 75 kW).

Drive type	Frame size	Nominal ratings			Light overload use		Heavy-duty use		Noise level (dB(A))	Heat dissipation (W)	Air flow (m ³ /h)
		I_N (A)	I_{MAX} (A)	P_N (kW)	I_{Ld} (A)	P_{Ld} (kW)	I_{Hd} (A)	P_{Hd} (kW)			
ACS880-01-04A6-2	R1	4.6	6.3	0.75	4.4	0.75	3.7	0.55	46	73	44
ACS880-01-06A6-2	R1	6.6	7.8	1.1	6.3	1.1	4.6	0.75	46	94	44
ACS880-01-07A5-2	R1	7.5	11.2	1.5	7.1	1.5	6.6	1.1	46	122	44
ACS880-01-10A6-2	R1	10.6	12.8	2.2	10.1	2.2	7.5	1.5	46	172	44
ACS880-01-16A8-2	R2	16.8	18.0	4.0	16.0	4.0	10.6	2.2	51	232	88
ACS880-01-24A3-2	R2	24.3	28.6	5.5	23.1	5.5	16.8	4	51	337	88
ACS880-01-031A-2	R3	31.0	41	7.5	29.3	7.5	24.3	5.5	57	457	134
ACS880-01-046A-2	R4	46	64	11	44	11	38	7.5	62	500	134
ACS880-01-061A-2	R4	61	76	15	58	15	45	11	62	630	280
ACS880-01-075A-2	R5	75	104	18.5	71	18.5	61	15	62	680	280
ACS880-01-087A-2	R5	87	122	22	83	22	72	18.5	62	730	280
ACS880-01-115A-2	R6	115	148	30	109	30	87	22	67	840	435
ACS880-01-145A-2	R6	145	178	37	138	37	105	30	67	940	435
ACS880-01-170A-2	R7	170	247	45	162	45	145	37	67	1260	450
ACS880-01-206A-2	R7	206	287	55	196	55	169	45	67	1500	450
ACS880-01-274A-2	R8 ³⁾	274	362	75	260	75	213	55	65	2100	550

$U_N = 400$ V (range 380 to 415 V). The power ratings are valid at nominal voltage 400 V (0.55 to 250 kW).

Drive type	Frame size	Nominal ratings			Light overload use		Heavy-duty use		Noise level (dBA)	Heat dissipation (W)	Air flow (m ³ /h)
		I_N (A)	I_{MAX} (A)	P_N (kW)	I_{Ld} (A)	P_{Ld} (kW)	I_{Hd} (A)	P_{Hd} (kW)			
ACS880-01-02A4-3	R1	2.4	3.1	0.75	2.3	0.75	1.8	0.55	46	30	44
ACS880-01-03A3-3	R1	3.3	4.1	1.1	3.1	1.1	2.4	0.75	46	40	44
ACS880-01-04A0-3	R1	4.0	5.6	1.5	3.8	1.5	3.3	1.1	46	52	44
ACS880-01-05A6-3	R1	5.6	6.8	2.2	5.3	2.2	4.0	1.5	46	73	44
ACS880-01-07A2-3	R1	8.0	9.5	3	7.6	3	5.6	2.2	46	94	44
ACS880-01-09A4-3	R1	10	12.2	4	9.5	4	8.0	3	46	122	44
ACS880-01-12A6-3	R1	12.9	16	5.5	12	5.5	10	4	46	172	44
ACS880-01-017A-3	R2	17	21	7.5	16	7.5	12.6	5.5	51	232	88
ACS880-01-025A-3	R2	25	29	11	24	11	17	7.5	51	337	88
ACS880-01-032A-3	R3	32	42	15	30	15	25	11	57	457	134
ACS880-01-038A-3	R3	38	54	18.5	36	18.5	32	15	57	562	134
ACS880-01-045A-3	R4	45	64	22	43	22	38	18.5	62	667	134
ACS880-01-061A-3	R4	61	76	30	58	30	45	22	62	907	280
ACS880-01-072A-3	R5	72	104	37	68	37	61	30	62	1117	280
ACS880-01-087A-3	R5	87	122	45	83	45	72	37	62	1120	280
ACS880-01-105A-3	R6	105	148	55	100	55	87	45	67	1295	435
ACS880-01-145A-3	R6	145	178	75	138	75	105	55	67	1440	435
ACS880-01-169A-3	R7	169	247	90	161	90	145	75	67	1940	450
ACS880-01-206A-3	R7	206	287	110	196	110	169	90	67	2310	450
ACS880-01-246A-3	R8	246	350	132	234	132	206	110	65	3300	550
ACS880-01-293A-3	R8 ³⁾	293	418	160	278	160	246 ¹⁾	132	65	3900	550
ACS880-01-363A-3	R9 ⁶⁾	363	498	200	345	200	293	160	68	4800	1150
ACS880-01-430A-3	R9 ⁵⁾	430	545	250	400	200	363 ²⁾	200	68	6000	1150

$U_N = 500$ V (range 380 to 500 V). The power ratings are valid at nominal voltage 500 V (0.55 to 250 kW).

Drive type	Frame size	Nominal ratings			Light overload use		Heavy-duty use		Noise level (dB(A))	Heat dissipation (W)	Air flow (m ³ /h)
		I_N (A)	I_{MAX} (A)	P_N (kW)	I_{Ld} (A)	P_{Ld} (kW)	I_{Hd} (A)	P_{Hd} (kW)			
ACS880-01-02A1-5	R1	2.1	3.1	0.75	2.0	0.75	1.7	0.55	46	30	44
ACS880-01-03A0-5	R1	3.0	4.1	1.1	2.8	1.1	2.1	0.75	46	40	44
ACS880-01-03A4-5	R1	3.4	5.6	1.5	3.2	1.5	3.0	1.1	46	52	44
ACS880-01-04A8-5	R1	4.8	6.8	2.2	4.6	2.2	3.4	1.5	46	73	44
ACS880-01-05A2-5	R1	5.2	9.5	3	4.9	3	4.8	2.2	46	94	44
ACS880-01-07A6-5	R1	7.6	12.2	4	7.2	4	5.2	3	46	122	44
ACS880-01-11A0-5	R1	11	16	5.5	10.4	5.5	7.6	4	46	172	44
ACS880-01-014A-5	R2	14	21	7.5	13	7.5	11	5.5	51	232	88
ACS880-01-021A-5	R2	21	29	11	19	11	14	7.5	51	337	88
ACS880-01-027A-5	R3	27	42	15	26	15	21	11	57	457	134
ACS880-01-034A-5	R3	34	54	18.5	32	18.5	27	15	57	562	134
ACS880-01-040A-5	R4	40	64	22	38	22	34	19	62	667	134
ACS880-01-052A-5	R4	52	76	30	49	30	40	22	62	907	280
ACS880-01-065A-5	R5	65	104	37	62	37	52	30	62	1117	280
ACS880-01-077A-5	R5	77	122	45	73	45	65	37	62	1120	280
ACS880-01-096A-5	R6	96	148	55	91	55	77	45	67	1295	435
ACS880-01-124A-5	R6	124	178	75	118	75	96	55	67	1440	435
ACS880-01-156A-5	R7	156	247	90	148	90	124	75	67	1940	450
ACS880-01-180A-5	R7	180	287	110	171	110	156	90	67	2310	450
ACS880-01-240A-5	R8 ⁴⁾	240	350	132	228	132	180	110	65	3300	550
ACS880-01-260A-5	R8 ³⁾	260	418	160	247	160	240 ¹⁾	132	65	3900	550
ACS880-01-361A-5	R9 ⁶⁾	361	542	200	343	200	302	200	68	4800	1150
ACS880-01-414A-5	R9 ⁵⁾	414	542	250	393	250	361 ²⁾	200	68	6000	1150

$U_N = 690$ V (range 525 to 690 V). The power ratings are valid at nominal voltage 690 V (4 to 250 kW).

Drive type	Frame size	Nominal ratings			Light overload use		Heavy-duty use		Noise level (dB(A))	Heat dissipation (W)	Air flow (m ³ /h)
		I_N (A)	I_{MAX} (A)	P_N (kW)	I_{Ld} (A)	P_{Ld} (kW)	I_{Hd} (A)	P_{Hd} (kW)			
ACS880-01-07A4-7	R3	7.4	12.2	5.5	7.0	5.5	5.6	4	57	114	134
ACS880-01-09A9-7	R3	9.9	18	7.5	9.4	7.5	7.4	5.5	57	143	134
ACS880-01-14A3-7	R3	14.3	22	11	13.6	11	9.9	7.5	57	207	134
ACS880-01-019A-7	R3	19	28.9	15	18.1	15	14.3	11	57	274	134
ACS880-01-023A-7	R3	23	38	18.5	21.9	18.5	19	15	57	329	134
ACS880-01-027A-7	R3	27	46	22	25.7	22	23	18.5	57	405	134
ACS880-01-035A-7	R5	35	64	30	33	30	26	22	62	864	280
ACS880-01-042A-7	R5	42	70	37	40	37	35	30	62	998	280
ACS880-01-049A-7	R5	49	71	45	47	45	42	37	62	1120	280
ACS880-01-061A-7	R6	61	104	55	58	55	49	45	67	1295	435
ACS880-01-084A-7	R6	84	124	75	80	75	61	55	67	1440	435
ACS880-01-098A-7	R7	98	168	90	93	90	84	75	67	1940	450
ACS880-01-119A-7	R7	119	198	110	113	110	98	90	67	2310	450
ACS880-01-142A-7	R8	142	250	132	135	132	119	110	65	3300	550
ACS880-01-174A-7	R8 ³⁾	174	274	160	165	160	142	132	65	3900	550
ACS880-01-210A-7	R9 ⁷⁾	210	384	200	200	200	174	160	68	4200	1150
ACS880-01-271A-7	R9 ⁵⁾	271	411	250	257	250	210	200	68	4800	1150

Nominal ratings

I_N	Rated current available continuously without overloadability at 40 °C.
P_N	Typical motor power in no-overload use.

Maximum output current

I_{max}	Maximum output current. Available for 10 seconds at start, then as long as allowed by drive temperature.
-----------	--

Light-overload use

I_{Ld}	Continuous current allowing 110% I_{Ld} for 1 minute every 5 minutes at 40 °C.
P_{Ld}	Typical motor power in light-overload use.

Heavy-duty use

I_{Hd}	Continuous current allowing 150% I_{Hd} for 1 minute every 5 minutes at 40 °C.
P_{Hd}	Typical motor power in heavy-duty use.

The ratings apply at 40 °C ambient temperature. At higher temperatures (up to 55 °C) the derating is 1%/1 °C.

¹⁾ 130% overload

²⁾ 125% overload

³⁾ For drives with enclosure class IP55 the ratings apply at 40 °C ambient temperature .

At higher temperature the derating is from 40 to 45 °C 1%/1 °C and 45 to 55 °C 2.5%/1 °C.

⁴⁾ For drives with enclosure class IP55 the ratings apply at 40 °C ambient temperature.

At higher temperature the derating is from 40 to 50 °C 1%/1 °C and 50 to 55 °C 2.5%/1 °C.

⁵⁾ For drives with enclosure class IP55 the maximum ambient temperature is 35 °C

⁶⁾ For drives with enclosure class IP55 the ratings apply at 40 °C ambient temperature.

At higher temperatures the derating is from 40 to 45 °C.

1%/1 °C and 45 to 50 °C 2.5%/1 °C and 50 to 55 °C 5%/1 °C.

⁷⁾ For drives with IP55 enclosure class the ratings apply at 40 °C ambient temperature.

At higher temperatures the derating is from 40 to 45 °C 3.5%/1 °C.

Note: Maximum ambient temperature is 45 °C.

⁸⁾ 135% overload

Single drive modules

ACS880-04/04F and ACS880-04XT/04FXT



— 01 ACS880-04 standard single drive module

— 02 ACS880-04 flat (sideways) mounting single drive module variant

— 03 ACS880-04XT high power single drive unit with parallel connected modules

— 04 ACS880-04F flange mounted single drive module

— 05 ACS880-04FXT flange mounted high power single drive unit with parallel connected modules

Flexibility and ease of cabinet assembly

The modules have all the essential features built-in including a choke for harmonic filtering as standard, and options such as a brake chopper, EMC filter and communication protocol adapter, functional safety and I/O extension modules. The all built-in design combined with IP20 protection significantly simplifies engineering.

The drive's compact size, flexible cabling directions and versatile mounting possibilities from narrow bookshelf to flat mounting and horizontal mounting make it an ideal fit for almost any enclosure. The control unit with I/O and communication connections can be mounted outside the power module or integrated into it.

The flange mounting variant (-04F/04FXT) with IP55 heat sink makes the drive suitable for harsh environments. High power units with parallel connected drive modules extends the power range with -04XT up to 1200 kW and with -04FXT up to 2400 kW.

The drives have an extensive selection of built-in features and options. See page 98.

Highlights

- IP20 enclosure class
- Compact package with all the essential features built-in
- Wheels for easy maneuvering (-04/04XT)
- Flexible mounting and cabling directions
- Optimal drive layout
- Possibility for flange (push through) mounting (-04F/04FXT)
- Tools and documents to support engineering (e.g. installation videos, EPLAN macros, accessories selection tool)
- Possibility for 6- or 12-pulse configurations (-04XT)
6-, 12-, 18- or 24-pulse configurations (-04FXT)

Single drive modules,

ACS880-04/04F/04XT/04FXT

- Power ratings: 200 to 2400 kW
- Enclosure classes: -04: IP20, -04F: IP20 (IP55 for heat sink side), -04XT: IP00, IP20 with optional shrouds, -04FXT: IP00, IP20 with optional shrouds (IP55 for heat sink side).

Main options:

- C2 and C3 EMC filters, see page 66
- Flat (sideways) mounting (-04/04XT)
- Various cabling related options, see page 92
- Brake chopper and resistor, see page 80
- Marine type approvals (-04/04XT)
- I/O extension modules, see page 60
- Communication protocol adapters, see page 60
- Application specific software, see page 16
- Speed feedback interfaces, see page 69
- Remote monitoring options, see page 70
- Functional safety modules, see page 72
- Du/dt filters, see page 88
- Sine filters, see page 76

High power single drive module packages ACS880-04



01



02

01 ACS880 high power drive module package with D8T+2×R8i

02 ACS880 R8i module which is used in ACS880-04 module packages

Ready-made packages for easy installation

The ACS880-04 high power single drive module package includes a supply unit and a separate inverter unit. The supply unit consists of D7T or D8T half-controlled diode modules with thyristor charging. Parallel connected R8i modules are utilized in the inverter unit. The drive module packages are ready-dimensioned and are available as 6-pulse or 12-pulse variants.

Installing and transporting the modules is easy, as they are equipped with wheels. Connecting the modules to the motor cables inside the cabinet is fast with the quick connectors. The modules can also be easily pulled out from a cabinet without any need for disconnecting the motor cables. The inverter module comes equipped with a removable fan pedestal, which makes motor cabling easy. To further shorten the engineering and assembly time several mechanical and electrical accessories are available.

High power single drive module packages, ACS880-04

- Power ratings: 400 to 2200 kW
- Enclosure classes: IP00
- Built-in choke as standard for input harmonics reduction
- External control unit
- Speed controlled cooling fans
- Large power terminals allowing the use of a wide range of cable sizes
- Internal du/dt filters as standard in R8i inverter modules

Main options:

- EMC filters, see page 74
- Brake chopper and resistor, see page 80
- Internal module heaters
- Direct-on-line, DOL, cooling fans

The drives have an extensive selection of built-in features and options. See page 98.

Highlights

- Optimized design for easy cabinet assembly (comes with wheels and quick connectors for motor cables)
- Wide selection of installation accessories
- Compact and modular design
- Complete cabinet design for Rittal VX25 cabinet installation
- Tools and documents to support engineering (e.g. installation videos, EPLAN macros, accessories selection tool, 3D models)
- Simple selection and ordering with ready-dimensioned module packages

Ratings, types and voltages

ACS880-04, -04F, -04XT, -04FXT

$U_N = 400$ V (range 380 to 415 V). The power ratings are valid at nominal voltage 400 V (200 to 1800 kW).

Drive type	Frame size	Nominal ratings				Light overload use		Heavy-duty use		Noise level (dB(A))	Heat dissipation (W)	Air flow (m ³ /h)
		I_N (A)	I_{max} (A)	I_{max_start} (A)	P_N (kW)	I_{Ld} (A)	P_{Ld} (kW)	I_{Hd} (A)	P_{Hd} (kW)			
ACS880-04, 6-pulse												
ACS880-04-505A-3	R10	505	560	671	250	485	250	361	200	72	5602	1200
ACS880-04-585A-3	R10	585	730	828	315	575	315	429	250	72	6409	1200
ACS880-04-650A-3	R10	650	730	954	355	634	355	477	250	72	8122	1200
ACS880-04-725A-3	R11	725	1020	1100	400	715	400	566	315	72	8764	1200
ACS880-04-820A-3	R11	820	1020	1100	450	810	450	625	355	72	9862	1200
ACS880-04-880A-3	R11	880	1100	1100	500	865	500	725 ¹⁾	400	71	10578	1420
ACS880-04F												
ACS880-04F-504A-3	R11	504	560	671	250	485	250	361	200	75	5650	1520
ACS880-04F-584A-3	R11	584	730	828	315	575	315	429	250	75	6450	1520
ACS880-04F-649A-3	R11	649	730	954	355	634	355	477	250	75	8150	1520
ACS880-04F-725A-3	R11	725	1020	1100	400	715	400	566	315	75	8800	1520
ACS880-04F-820A-3	R11	820	1020	1100	450	810	450	625	355	75	9900	1520
ACS880-04F-880A-3	R11	880	1100	1100	500	865	500	725 ¹⁾	400	75	10600	1520
ACS880-04XT, 6- or 12-pulse												
ACS880-04XT-1010A-3	2xR10	1010	1270	1441	560	997	560	746	400	75	12818	2400
ACS880-04XT-1190A-3	2xR10	1190	1343	1755	630	1167	630	878	500	75	16244	2400
ACS880-04XT-1330A-3	2xR11	1330	1886	2024	710	1316	710	1041	560	75	17528	2400
ACS880-04XT-1610A-3	2xR11	1610	2024	2024	900	1570	900	1334 ¹⁾	710	74	21156	2840
ACS880-04FXT, 6-, 12-, 18- or 24-pulse												
ACS880-04FXT-1008A-3	2xR11	1008	1270	1441	560	997	560	746	400	78	12900	3040
ACS880-04FXT-1188A-3	2xR11	1188	1343	1755	630	1167	630	878	500	78	16300	3040
ACS880-04FXT-1330A-3	2xR11	1330	1886	2024	710	1316	710	1041	560	78	17600	3040
ACS880-04FXT-1610A-3	2xR11	1610	2024	2024	900	1570	900	1334 ¹⁾	710	78	21200	3040
ACS880-04FXT-2000A-3	3xR11	2000	2829	3036	1000	1973	1000	1562	900	79	26400	4560
ACS880-04FXT-2430A-3	3xR11	2430	3036	3036	1400	2387	1200	2001 ¹⁾	1000	79	31800	4560
ACS880-04FXT-2026A-3	4xR11	2026	2540	2881	1000	2001	1000	1493	800	80	25800	6080
ACS880-04FXT-2386A-3	4xR11	2386	2686	3510	1200	2333	1200	1755	900	80	32600	6080
ACS880-04FXT-2660A-3	4xR11	2660	3772	4048	1400	2631	1400	2083	1000	80	35200	6080
ACS880-04FXT-3230A-3	4xR11	3230	4048	4048	1800	3183	1800	2668 ¹⁾	1400	80	42400	6080

¹⁾ = Continuous rms output current allowing 40% overload for 1 minute every 5 minutes

Nominal ratings

I_N	Rated current available continuously without overloadability at 40 °C.
P_N	Typical motor power in no-overload use.

Maximum output current

I_{max}	Maximum output current. Available for 10 seconds at start, then as long as allowed by drive temperature.
I_{max_start}	Maximum output current at start. When enabled, available for 2 seconds only at start every 7 seconds.

Light-overload use

I_{Ld}	Continuous current allowing 110% I_{Ld} for 1 minute every 5 minutes at 40 °C.
P_{Ld}	Typical motor power in light-overload use.

Heavy-duty use

I_{Hd}	Continuous current allowing 150% I_{Hd} for 1 minute every 5 minutes at 40 °C.
P_{Hd}	Typical motor power in heavy-duty use.

The ratings apply at 40 °C ambient temperature. At higher temperatures (up to 50 °C⁴⁾ or up to 55 °C⁵⁾) the derating is 1%/1 °C.

⁴⁾ ACS880-04 high power single drive package.

⁵⁾ ACS880-04 single drive module.

$U_N = 500$ V (range 380 to 500 V). The power ratings are valid at nominal voltage 500 V (200 to 2000 kW).

Drive type	Frame size	Nominal ratings				Light overload use		Heavy-duty use		Noise level (dB(A))	Heat dissipation (W)	Air flow (m ³ /h)
		I_N (A)	I_{max} (A)	I_{max_start} (A)	P_N (kW)	I_{Ld} (A)	P_{Ld} (kW)	I_{Hd} (A)	P_{Hd} (kW)			
ACS880-04, 6-pulse												
ACS880-04-460A-5	R10	460	560	671	315	450	315	330	200	72	4403	1200
ACS880-04-503A-5	R10	503	560	671	355	483	315	361	250	72	5602	1200
ACS880-04-583A-5	R10	583	730	828	400	573	400	414	250	72	6409	1200
ACS880-04-635A-5	R10	635	730	954	450	623	450	477	315	72	8122	1200
ACS880-04-715A-5	R11	715	850	1100	500	705	500	566	400	72	8764	1200
ACS880-04-820A-5	R11	820	1020	1100	560	807	560	625	450	71	9862	1420
ACS880-04-880A-5	R11	880	1100	1100	630	857	560	697 ²⁾	500	71	11078	1420
ACS880-04F												
ACS880-04F-459A-5	R11	459	560	671	315	450	315	330	200	75	4450	1520
ACS880-04F-502A-5	R11	502	560	671	355	483	315	361	250	75	5650	1520
ACS880-04F-582A-5	R11	582	730	828	400	573	400	414	250	75	6450	1520
ACS880-04F-634A-5	R11	634	730	954	450	623	450	477	315	75	8150	1520
ACS880-04F-715A-5	R11	715	850	1100	500	705	500	566	400	75	8800	1520
ACS880-04F-820A-5	R11	820	1020	1100	560	807	560	625	450	75	9900	1520
ACS880-04F-880A-5	R11	880	1100	1100	630	857	560	697 ²⁾	500	75	11100	1520
ACS880-04XT, 6- or 12-pulse												
ACS880-04XT-1010A-5	2xR10	1010	1270	1441	710	997	710	720	500	75	12818	2400
ACS880-04XT-1160A-5	2xR10	1160	1343	1755	800	1146	800	878	630	75	16244	2400
ACS880-04XT-1310A-5	2xR11	1310	1564	2024	900	1297	900	1041	710	75	17528	2400
ACS880-04XT-1610A-5	2xR11	1610	2024	2024	1000	1570	1000	1282 ²⁾	900	74	21156	2840
ACS880-04FXT, 6- or 12-pulse												
ACS880-04FXT-1008A-5	2xR11	1008	1270	1441	710	997	710	720	500	78	12900	3040
ACS880-04FXT-1158A-5	2xR11	1158	1343	1755	800	1146	800	878	630	78	16300	3040
ACS880-04FXT-1310A-5	2xR11	1310	1564	2024	900	1297	900	1041	710	78	17600	3040
ACS880-04FXT-1610A-5	2xR11	1610	2024	2024	1000	1570	1000	1282 ²⁾	900	78	22200	3040
ACS880-04FXT-1970A-5	3xR11	1970	2346	3036	1400	1946	1400	1562	1000	79	26400	4560
ACS880-04FXT-2340A-5	3xR11	2430	3036	3036	1600	2365	1600	1924 ²⁾	1200	79	33300	4560
ACS880-04FXT-2016A-5	4xR11	2016	2540	2881	1400	1994	1400	1441	1000	80	25800	6080
ACS880-04FXT-2326A-5	4xR11	2326	2686	3510	1600	2293	1600	1755	1200	80	32600	6080
ACS880-04FXT-2630A-5	4xR11	2630	3128	4048	1800	2594	1800	2083	1400	80	35200	6080
ACS880-04FXT-3230A-5	4xR11	3230	4048	4048	2000	3154	2000	2565 ²⁾	1800	80	44400	6080

²⁾ = Continuous rms output current allowing 45% overload for 1 minute every 5 minutes

$U_N = 690$ V (range 525 to 690 V). The power ratings are valid at nominal voltage 690 V (250 to 2400 kW).

Drive type	Frame size	Nominal ratings				Light overload use		Heavy-duty use		Noise level (dB(A))	Heat dissipation (W)	Air flow (m ³ /h)
		I_N (A)	I_{max} (A)	I_{max_start} (A)	P_N (kW)	I_{Ld} (A)	P_{Ld} (kW)	I_{Hd} (A)	P_{Hd} (kW)			
ACS880-04, 6-pulse												
ACS880-04-330A-7	R10	330	480	510	315	320	315	255	250	72	4403	1200
ACS880-04-370A-7	R10	370	520	650	355	360	355	325	315	72	5602	1200
ACS880-04-430A-7	R10	430	540	720	400	420	450	360 ³⁾	350	72	6409	1200
ACS880-04-470A-7	R11	470	655	830	450	455	450	415	400	72	8122	1200
ACS880-04-522A-7	R11	522	685	910	500	505	500	455	450	72	8764	1200
ACS880-04-590A-7	R11	590	800	1010	560	571	560	505	500	71	9862	1200
ACS880-04-650A-7	R11	650	825	1100	630	630	630	571 ³⁾	560	71	10578	1420
ACS880-04-721A-7	R11	721	825	1100	710	705	630	571 ³⁾	560	71	10578	1420
ACS880-04F												
ACS880-04F-329A-7	R11	329	480	510	315	320	315	255	250	75	4450	1520
ACS880-04F-369A-7	R11	369	520	650	355	360	355	325	315	75	5650	1520
ACS880-04F-429A-7	R11	429	520	720	400	420	400	360 ³⁾	355	75	6450	1520
ACS880-04F-470A-7	R11	470	655	830	450	455	450	415	400	75	8150	1520
ACS880-04F-522A-7	R11	522	655	910	500	505	500	455	450	75	8800	1520
ACS880-04F-590A-7	R11	590	800	1010	560	571	560	505	500	75	9900	1520
ACS880-04F-650A-7	R11	650	820	1100	630	630	630	571 ³⁾	560	75	11100	1520
ACS880-04F-721A-7	R11	721	820	1100	710	705	630	571 ³⁾	560	75	11100	1520
ACS880-04XT, 6- or 12-pulse												
ACS880-04XT-0810A-7	2xR10	810	1017	1356	800	791	710	678 ³⁾	630	75	12818	2400
ACS880-04XT-0960A-7	2xR11	960	1260	1674	900	929	900	837	800	75	17528	2400
ACS880-04XT-1080A-7	2xR11	1080	1472	1858	1000	1051	1000	929	900	75	19724	2400
ACS880-04XT-1320A-7	2xR11	1320	1509	2024	1200	1297	1200	1051 ³⁾	1000	74	21156	2840
ACS880-04FXT, 6- or 12-pulse												
ACS880-04FXT-0808A-7	2xR11	808	1017	1356	800	791	710	678 ³⁾	630	78	12900	3040
ACS880-04FXT-0960A-7	2xR11	960	1260	1674	900	929	900	837	800	78	17600	3040
ACS880-04FXT-1080A-7	2xR11	1080	1472	1858	1000	1051	1000	929	900	78	19800	3040
ACS880-04FXT-1320A-7	2xR11	1320	1509	2024	1200	1297	1200	1051 ³⁾	1000	78	22200	3040
ACS880-04FXT-1630A-7	3xR11	1630	2208	2788	1600	1576	1400	1394	1200	79	29700	4560
ACS880-04FXT-1990A-7	3xR11	1990	2277	3036	1800	1946	1800	1576 ³⁾	1400	79	33300	4560
ACS880-04FXT-1576A-7	4xR11	1576	1987	2650	1400	1546	1400	1325 ³⁾	1200	80	25800	6080
ACS880-04FXT-1920A-7	4xR11	1920	2521	3349	1800	1858	1800	1674	1600	80	35200	6080
ACS880-04FXT-2170A-7	4xR11	2170	2944	3717	2000	2101	2000	1858	1800	80	39600	6080
ACS880-04FXT-2650A-7	4xR11	2650	3036	4048	2400	2594	2400	2101 ³⁾	2000	80	44400	6080

³⁾ = Continuous rms output current allowing 44% overload for 1 minute every 5 minutes

Nominal ratings

I_N	Rated current available continuously without overloadability at 40 °C.
P_N	Typical motor power in no-overload use.

Maximum output current

I_{max}	Maximum output current. Available for 10 seconds at start, then as long as allowed by drive temperature.
I_{max_start}	Maximum output current at start. When enabled, available for 2 seconds only at start every 7 seconds.

Light-overload use

I_{Ld}	Continuous current allowing 110% I_{Ld} for 1 minute every 5 minutes at 40 °C.
P_{Ld}	Typical motor power in light-overload use.

Heavy-duty use

I_{Hd}	Continuous current allowing 150% I_{Hd} for 1 minute every 5 minutes at 40 °C.
P_{Hd}	Typical motor power in heavy-duty use.

The ratings apply at 40 °C ambient temperature. At higher temperatures (up to 50 °C⁴⁾ or up to 55 °C⁵⁾ the derating is 1%/1 °C.

⁴⁾ ACS880-04 high power single drive package.

⁵⁾ ACS880-04 single drive module.



Ratings, types and voltages

ACS880-04 nxR8i

$U_N = 400$ V (range 380 to 415 V). The power ratings are valid at nominal voltage 400 V (400 to 1400 kW).

Drive type	Frame size	Nominal ratings			Light overload use		Heavy-duty use		Noise level (dB(A))	Heat dissipation (W)	Air flow (m ³ /h)
		I_N (A)	I_{max} (A)	P_N (kW)	I_{Ld} (A)	P_{Ld} (kW)	I_{Hd} (A)	P_{Hd} (kW)			
6-pulse											
ACS880-04-1140A-3	D8T+2×R8i	1140	1482	630	1072	560	787	400	73	18000	4290
ACS880-04-1250A-3	2×D8T+2×R8i	1250	1630	710	1200	630	935	500	74	21000	5720
ACS880-04-1480A-3	2×D8T+2×R8i	1480	1930	800	1421	800	1107	630	74	25000	5720
ACS880-04-1760A-3	2×D8T+2×R8i	1760	2120	1000	1690	900	1316	710	74	29000	5720
ACS880-04-2210A-3	3×D8T+3×R8i	2210	2880	1200	2122	1200	1653	900	76	37000	8580
ACS880-04-2610A-3	3×D8T+3×R8i	2610	3140	1400	2506	1400	1952	1000	76	44000	8580
6- or 12-pulse											
ACS880-04-0990A-3+A004	2×D7T+2×R8i	990	1287	560	950	500	741	400	73	15000	5720
ACS880-04-1250A-3+A004	2×D8T+2×R8i	1250	1630	710	1200	630	935	500	74	21000	5720
ACS880-04-1480A-3+A004	2×D8T+2×R8i	1480	1930	800	1421	800	1107	630	74	25000	5720
ACS880-04-1760A-3+A004	2×D8T+2×R8i	1760	2120	1000	1690	900	1316	710	74	29000	5720
ACS880-04-2210A-3+A004	4×D8T+3×R8i	2210	2880	1200	2122	1200	1653	900	76	35000	10010
ACS880-04-2610A-3+A004	4×D8T+3×R8i	2610	3140	1400	2506	1400	1952	1000	76	44000	10010

$U_N = 500$ V (range 380 to 500 V). The power ratings are valid at nominal voltage 500 V (560 to 1400 kW).

Drive type	Frame size	Nominal ratings			Light overload use		Heavy-duty use		Noise level (dB(A))	Heat dissipation (W)	Air flow (m ³ /h)
		I_N (A)	I_{max} (A)	P_N (kW)	I_{Ld} (A)	P_{Ld} (kW)	I_{Hd} (A)	P_{Hd} (kW)			
6-pulse											
ACS880-04-1070A-5	D8T+2×R8i	1070	1391	710	1027	710	800	560	73	18000	4290
ACS880-04-1320A-5	2×D8T+2×R8i	1320	1716	900	1267	900	987	710	74	22000	5720
ACS880-04-1450A-5	2×D8T+2×R8i	1450	1890	1000	1392	900	1085	710	74	25000	5720
ACS880-04-1580A-5	2×D8T+2×R8i	1580	2060	1100	1517	1000	1182	800	74	27000	5720
ACS880-04-1800A-5	2×D8T+3×R8i	1800	2340	1250	1728	1200	1346	900	75	32000	7150
ACS880-04-1980A-5	2×D8T+3×R8i	1980	2574	1400	1901	1300	1481	1000	75	36000	7150
6- or 12-pulse											
ACS880-04-0990A-5+A004	2×D7T+2×R8i	990	1287	710	950	630	741	500	73	16000	5720
ACS880-04-1320A-5+A004	2×D8T+2×R8i	1320	1716	900	1267	900	987	710	74	22000	5720
ACS880-04-1450A-5+A004	2×D8T+2×R8i	1450	1890	1000	1392	900	1085	710	74	25000	5720
ACS880-04-1580A-5+A004	2×D8T+2×R8i	1580	2060	1100	1517	1000	1182	800	74	27000	5720
ACS880-04-1800A-5+A004	2×D8T+3×R8i	1800	2340	1250	1728	1200	1346	900	75	32000	7150
ACS880-04-1980A-5+A004	2×D8T+3×R8i	1980	2574	1400	1901	1300	1481	1000	75	36000	7150

$U_N = 690$ V (range 525 to 690 V). The power ratings are valid at nominal voltage 690 V (560 to 2200 kW).

Drive type	Frame size	Nominal ratings			Light overload use		Heavy-duty use		Noise level	Heat dissipation (W)	Air flow (m ³ /h)
		I_N (A)	I_{max} (A)	P_N (kW)	I_{Ld} (A)	P_{Ld} (kW)	I_{Hd} (A)	P_{Hd} (kW)			
6-pulse											
ACS880-04-0800A-7	D8T+2×R8i	800	1200	800	768	710	598	560	73	16000	4290
ACS880-04-0900A-7	D8T+2×R8i	900	1350	900	864	800	673	630	74	20000	4290
ACS880-04-1160A-7	2×D8T+2×R8i	1160	1740	1100	1114	1100	868	800	74	26000	5720
ACS880-04-1450A-7	2×D8T+3×R8i	1450	2175	1400	1392	1250	1085	1000	75	32000	7150
ACS880-04-1650A-7	2×D8T+3×R8i	1650	2475	1600	1584	1500	1234	1200	75	36500	7150
ACS880-04-2300A-7	3×D8T+4×R8i	2300	3450	2200	2208	2000	1720	1600	76	52000	10010
6- or 12-pulse											
ACS880-04-0800A-7+A004	2×D7T+2×R8i	800	1200	800	768	710	598	560	73	16000	5720
ACS880-04-0950A-7+A004	2×D8T+2×R8i	950	1425	900	912	800	711	630	74	20000	5720
ACS880-04-1160A-7+A004	2×D8T+2×R8i	1160	1740	1100	1114	1100	868	800	74	26000	5720
ACS880-04-1450A-7+A004	2×D8T+3×R8i	1450	2175	1400	1392	1250	1085	1000	75	32000	7150
ACS880-04-1650A-7+A004	2×D8T+3×R8i	1650	2475	1600	1584	1500	1234	1200	75	36500	7150
ACS880-04-2300A-7+A004	4×D8T+4×R8i	2300	3450	2200	2208	2000	1720	1600	77	52000	11440

Nominal ratings

I_N	Rated current available continuously without overloadability at 40 °C.
P_N	Typical motor power in no-overload use.

Maximum output current

I_{max}	Maximum output current. Available for 10 seconds at start, then as long as allowed by drive temperature.
I_{max_start}	Maximum output current at start. When enabled, available for 2 seconds only at start every 7 seconds.

Light-overload use

I_{Ld}	Continuous current allowing 110% I_{Ld} for 1 minute every 5 minutes at 40 °C.
P_{Ld}	Typical motor power in light-overload use.

Heavy-duty use

I_{Hd}	Continuous current allowing 150% I_{Hd} for 1 minute every 5 minutes at 40 °C.
P_{Hd}	Typical motor power in heavy-duty use.

The ratings apply at 40 °C ambient temperature. At higher temperatures (up to 50 °C or up to 55 °C) the derating is 1%/1 °C.

Regenerative drive modules

ACS880-11+P940 and ACS880-14

—
01 Speed and
power curves in
cyclic operation

ABB regenerative drive modules are optimized for cabinet assembly. ACS880-11+P940 and ACS880-14 frame R11 are compact and complete drive solutions, with everything needed for regenerative operation in cyclic or continuous braking applications. For high power applications ACS880-14 single drive module packages are available. The package consists of a regenerative supply unit with a line filter and of a separate inverter unit. R8i modules are utilized in both units, and the package is ready-dimensioned.

Energy savings

With regenerative functionality, the braking energy of the motor is returned to the drive and distributed to the supply network so that it can be utilized by other equipment. Compared to mechanical or resistor braking, where braking energy is wasted as heat, regenerative drive operation offers significant savings in energy consumption and cooling.

The drive reaches a unity power factor. This high power factor indicates that electrical energy is used to its full potential.

Minimized downtime

Regenerative drive offers immunity to network disturbances. The drive will not interrupt the process or affect its quality in unstable supply network conditions. Drive's active supply unit is able to boost output voltage, enabling full motor voltage even when the supply voltage is below nominal. The drive can even compensate for rapid variations in supply voltage, ensuring reliable operation during network fluctuations. Voltage boost capability can also be utilized to overcome a voltage drop caused by long supply or motor cables or output filters.

Optimized cost and space

Everything needed for regenerative operation, such as an active supply unit and low harmonic line filter are included, and no external braking devices are needed.

Advantages:

- Quick, easy drive installation
- Small installation footprint
- No need to add cooling to handle the heat generated by mechanical or resistor braking
- Simplified wiring
- Less spare parts needed

The “all inside” design for frames up to R11 and mechanical installation kits for module packages help to cut engineering and assembly time, as well as to reduce equipment costs and the risk of errors.

The drive's voltage boost capability can be an advantage in motor dimensioning. With a higher motor voltage, the same power is achieved with less current, which may allow a smaller motor to be used.

The drive offers a possibility for network power factor correction to compensate for low power factors of equipment connected to the same network. It reduces the need for additional power factor correction equipment, such as filters and large capacitor banks. It can also help to avoid penalty charges from electrical utilities for poor power factors.

Maximized motor performance and efficiency

The drive is able to provide full motor voltage in all conditions. Regeneration can occur for as long as necessary and as often as needed.

The drive features direct torque control (DTC) as standard, making it suitable also for very demanding applications. DTC provides precise speed and torque control for maximum motor performance and motor efficiency.

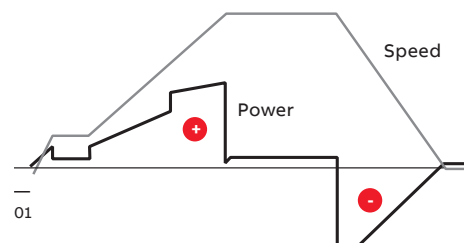

Low harmonic content

The drive produces exceptionally low harmonic content and exceeds the requirements of even the most stringent harmonic recommendations, like IEEE 519, IEC 61000-3-2, IEC 61000-3-12 and G5/4. Compared to conventional drives, the harmonic content is up to 97% lower. The total harmonic current distortion is typically <3% in nominal situation and undistorted network.

For more information, visit <https://new.abb.com/drives/regenerativedrives>.

— 01 ACS880-11+P940

— 02 ACS880-14
frame size R11

— 03 ACS880-14 drive
module package,
BLCL line filter and
R8i modules



— 01



— 02



— 03

Regenerative single drive modules, ACS880-11+P940 and ACS880-14 frame R11

- Power ratings: 2.2 to 400 kW
- Enclosure classes: IP20, in flange mounting (ACS880-11) heat sink side IP55

Main options:

- Flange mounting
- C2 and C3 EMC filters, see page 74
- I/O extension modules, see page 68
- Communication protocol adapters, see page 68
- Speed feedback interfaces, see page 69
- Functional safety modules, see page 72
- Remote monitoring options, see page 70
- Application specific software, see page 16
- Du/dt filters, see page 88
- Sine filters, see page 76

Regenerative single drive module package, ACS880-14, BLCL line filter and R8i frames

- Power ratings: 160 to 2200 kW
- Enclosure class: IP00
- External control unit
- Speed controlled cooling fans in R8i modules. Direct-on-line fans in BLCL filters.
- Internal du/dt filters in R8i modules

Main options:

- C2 EMC filters, see page 74
- I/O extension modules, see page 68
- Communication protocol adapters, see page 68
- Speed feedback interfaces, see page 69
- Functional safety modules, see page 72
- Remote monitoring options, see page 70
- Application specific software, see page 16
- Internal heaters in R8i and BLCL modules
- Direct-on-line cooling fans

The drives have an extensive selection of built-in features and options. See page 98.

Highlights

- Everything for regenerative operation in one compact IP20 package up to 400 kW / frame R11
- Possibility to regenerate 100% of the power continuously
- The total harmonic current distortion is typically <3% in nominal situation and undistorted network
- Clear energy savings compared to other braking methods
- Unity power factor. Possibility also for network power factor correction
- Stable output voltage in all load conditions, even with fluctuating supply voltage
- Mechanical installation kits for easy engineering and assembly of module packages
- Possibility for flange (push through) mounting up to frame R11

Ratings, types and voltages

Wall-mounted regenerative drive modules, ACS880-11

$U_N = 400\text{ V}$ (range 380 to 415 V). The power ratings are valid at nominal voltage 400 V (3 to 110 kW).

Drive type	Frame size	Nominal ratings			Light overload use		Heavy-duty use		Noise level (dB(A))	Heat dissipation (W)	Air flow (m ³ /h)
		I_N (A)	I_{MAX} (A)	P_N (kW)	I_{Ld} (A)	P_{Ld} (kW)	I_{Hd} (A)	P_{Hd} (kW)			
ACS880-11-09A4-3	R3	10	13.6	4	9.5	4	8	3	57	226	361
ACS880-11-12A6-3	R3	12.9	17	5.5	12	5.5	10	4	57	329	361
ACS880-11-017A-3	R3	17	21.9	7.5	16	7.5	12.9	5.4	57	395	361
ACS880-11-025A-3	R3	25	28.8	11	24	11	17	7.5	57	579	361
ACS880-11-032A-3	R6	32	42.5	15	30	15	25	11	71	625	550
ACS880-11-038A-3	R6	38	54.4	18.5	36	18.5	32	15	71	751	550
ACS880-11-045A-3	R6	45	64.6	22	43	22	38	18.5	71	912	550
ACS880-11-061A-3	R6	61	76.5	30	58	30	45	22	71	1088	550
ACS880-11-072A-3	R6	72	103.7	37	68	37	61	30	71	1502	550
ACS880-11-087A-3	R6	87	122.4	45	83	45	72	37	71	1904	550
ACS880-11-105A-3	R8	105	148	55	100	55	87	45	68	1877	700
ACS880-11-145A-3	R8	145	178	75	138	75	105	55	68	2963	700
ACS880-11-169A-3	R8	169	247	90	161	90	145	75	68	3168	700
ACS880-11-206A-3	R8	206	287	110	196	110	169	90	68	3990	805

$U_N = 500\text{ V}$ (range 380 to 500 V). The power ratings are valid at nominal voltage 500 V (2.2 to 110 kW).

Drive type	Frame size	Nominal ratings			Light overload use		Heavy-duty use		Noise level (dB(A))	Heat dissipation (W)	Air flow (m ³ /h)
		I_N (A)	I_{MAX} (A)	P_N (kW)	I_{Ld} (A)	P_{Ld} (kW)	I_{Hd} (A)	P_{Hd} (kW)			
ACS880-11-07A6-5	R3	7.6	9.5	4	7.2	4	5.2	2.2	57	219	361
ACS880-11-11A0-5	R3	11	13.8	5.5	10.4	5.5	7.6	4	57	278	361
ACS880-11-014A-5	R3	14	18.7	7.5	13	7.5	11	5.5	57	321	361
ACS880-11-021A-5	R3	21	26.3	11	19	11	14	7.5	57	473	361
ACS880-11-027A-5	R6	27	35.7	15	26	15	21	11	71	625	550
ACS880-11-034A-5	R6	34	45.9	18.5	32	18.5	27	15	71	711	550
ACS880-11-040A-5	R6	40	57.8	22	38	22	34	18.5	71	807	550
ACS880-11-052A-5	R6	52	68	30	49	30	40	22	71	960	550
ACS880-11-065A-5	R6	65	88.4	37	62	37	52	30	71	1223	550
ACS880-11-077A-5	R6	77	110.5	45	73	45	65	37	71	1560	550
ACS880-11-101A-5	R8	101	148	55	91	55	77	45	68	1995	700
ACS880-11-124A-5	R8	124	178	75	118	75	96	55	68	2800	700
ACS880-11-156A-5	R8	156	247	90	148	90	124	75	68	3168	700
ACS880-11-180A-5	R8	180	287	110	171	110	156	90	68	3872	805

Nominal ratings

I_N	Rated current available continuously without overloadability at 40 °C.
P_N	Typical motor power in no-overload use.

Maximum output current

I_{max}	Maximum output current. Available for 10 seconds at start, then as long as allowed by drive temperature.
-----------	--

Light-overload use

I_{Ld}	Continuous current allowing 110% I_{Ld} for 1 minute every 5 minutes at 40 °C.
P_{Ld}	Typical motor power in light-overload use.

Heavy-duty use

I_{Hd}	Continuous current allowing 150% I_{Hd} for 1 minute every 5 minutes at 40 °C.
P_{Hd}	Typical motor power in heavy-duty use.

The ratings apply at 40 °C ambient temperature.

At higher temperatures (up to 55 °C) the derating is 1%/1 °C.

Ratings, types and voltages

Regenerative drive modules, ACS880-14 frame R11

$U_N = 400\text{ V}$ (range 380 to 415 V). The power ratings are valid at nominal voltage 400 V (110 to 355 kW).

Drive type	Frame size	Nominal ratings			Light overload use		Heavy-duty use		Noise level (dB(A))	Heat dissipation (W)	Air flow (m ³ /h)
		I_N (A)	I_{max} (A)	P_N (kW)	I_{Ld} (A)	P_{Ld} (kW)	I_{Hd} (A)	P_{Hd} (kW)			
ACS880-14-246A-3	R11	246	350	132	234	132	206	110	75	5280	2100
ACS880-14-293A-3	R11	293	418	160	278	160	246	132	75	6400	2100
ACS880-14-363A-3	R11	363	498	200	345	200	293	160	75	8000	2100
ACS880-14-442A-3	R11	442	545	250	420	250	363	200	75	10000	2100
ACS880-14-505A-3	R11	505	560	250	480	250	363	200	75	10000	2100
ACS880-14-585A-3	R11	585	730	315	556	315	442	250	75	12600	2100
ACS880-14-650A-3	R11	650	730	355	618	355	505	250	75	14200	2100

$U_N = 500\text{ V}$ (range 380 to 500 V). The power ratings are valid at nominal voltage 500 V (110 to 355 kW).

Drive type	Frame size	Nominal ratings			Light overload use		Heavy-duty use		Noise level (dB(A))	Heat dissipation (W)	Air flow (m ³ /h)
		I_N (A)	I_{max} (A)	P_N (kW)	I_{Ld} (A)	P_{Ld} (kW)	I_{Hd} (A)	P_{Hd} (kW)			
ACS880-14-240A-5	R11	240	350	132	228	132	180	110	75	5280	2100
ACS880-14-260A-5	R11	260	418	160	247	160	240	132	75	6400	2100
ACS880-14-361A-5	R11	361	542	200	343	200	260	160	75	8000	2100
ACS880-14-414A-5	R11	414	542	250	393	250	361	200	75	10000	2100
ACS880-14-460A-5	R11	460	560	315	450	315	414	250	75	12600	2100
ACS880-14-503A-5	R11	503	560	355	492	355	460	315	75	14200	2100

$U_N = 690\text{ V}$ (range 525 to 690 V). The power ratings are valid at nominal voltage 690 V (110 to 400 kW).

Drive type	Frame size	Nominal ratings			Light overload use		Heavy-duty use		Noise level (dB(A))	Heat dissipation (W)	Air flow (m ³ /h)
		I_N (A)	I_{max} (A)	P_N (kW)	I_{Ld} (A)	P_{Ld} (kW)	I_{Hd} (A)	P_{Hd} (kW)			
ACS880-14-142A-7	R11	142	250	132	135	132	119	110	75	5280	2100
ACS880-14-174A-7	R11	174	274	160	165	160	142	132	75	6400	2100
ACS880-14-210A-7	R11	210	384	200	200	200	174	160	75	8000	2100
ACS880-14-271A-7	R11	271	411	250	257	250	210	200	75	10000	2100
ACS880-14-330A-7	R11	330	480	315	320	315	271	250	75	12600	2100
ACS880-14-370A-7	R11	370	520	355	360	355	330	315	75	14200	2100
ACS880-14-430A-7	R11	430	520	400	420	400	370	355	75	16000	2100

Ratings, types and voltages

Regenerative drive module packages, ACS880-14

$U_N = 400\text{ V}$ (range 380 to 415 V). The power ratings are valid at nominal voltage 400 V (160 to 1400 kW).

Drive type	Frame size	Nominal ratings			Light overload use		Heavy-duty use		Noise level (dB(A))	Heat dissipation (W)	Air flow (m ³ /h)
		I_N (A)	I_{max} (A)	P_N (kW)	I_{Ld} (A)	P_{Ld} (kW)	I_{Hd} (A)	P_{Hd} (kW)			
ACS880-14-0450A-3	R8i + BLCL-13-5 + R8i	450	590	250	432	200	337	160	75	14000	3760
ACS880-14-0620A-3	R8i + BLCL-13-5 + R8i	620	810	355	595	315	464	250	75	18000	3760
ACS880-14-0870A-3	R8i + BLCL-15-5 + R8i	870	1140	500	835	450	651	355	75	27000	3760
ACS880-14-1210A-3	2xR8i + BLCL-24-5 + 2xR8i	1210	1580	710	1162	630	905	500	77	34000	7220
ACS880-14-1430A-3	2xR8i + BLCL-24-5 + 2xR8i	1430	1860	800	1373	710	1070	560	77	38000	7220
ACS880-14-1700A-3	2xR8i + BLCL-25-5 + 2xR8i	1700	2210	1000	1632	900	1272	710	77	51000	7220
ACS880-14-2060A-3	3xR8i + 2xBLCL-24-5 + 3xR8i	2060	2680	1200	1978	1100	1541	800	78	61000	11580
ACS880-14-2530A-3	3xR8i + 2xBLCL-24-5 + 3xR8i	2530	3290	1400	2429	1200	1892	1000	78	76000	11580

$U_N = 500\text{ V}$ (range 380 to 500 V). The power ratings are valid at nominal voltage 500 V (200 to 1600 kW).

Drive type	Frame size	Nominal ratings			Light overload use		Heavy-duty use		Noise level (dB(A))	Heat dissipation (W)	Air flow (m ³ /h)
		I_N (A)	I_{max} (A)	P_N (kW)	I_{Ld} (A)	P_{Ld} (kW)	I_{Hd} (A)	P_{Hd} (kW)			
ACS880-14-0420A-5	R8i + BLCL-13-5 + R8i	420	550	250	403	250	314	200	75	13000	3760
ACS880-14-0570A-5	R8i + BLCL-13-5 + R8i	570	750	400	547	355	426	250	75	17000	3760
ACS880-14-0780A-5	R8i + BLCL-15-5 + R8i	780	1020	560	749	500	583	400	75	25000	3760
ACS880-14-1110A-5	2xR8i + BLCL-24-5 + 2xR8i	1110	1450	800	1066	710	830	560	77	32000	7220
ACS880-14-1530A-5	2xR8i + BLCL-25-5 + 2xR8i	1530	1990	1100	1469	1000	1144	800	77	46000	7220
ACS880-14-1980A-5	3xR8i + 2xBLCL-24-5 + 3xR8i	1980	2580	1400	1901	1300	1481	1000	78	59000	11580
ACS880-14-2270A-5	3xR8i + 2xBLCL-24-5 + 3xR8i	2270	2960	1600	2179	1500	1698	1200	78	69000	11580

$U_N = 690\text{ V}$ (range 525 to 690 V). The power ratings are valid at nominal voltage 690 V (200 to 2200 kW).

Drive type	Frame size	Nominal ratings			Light overload use		Heavy-duty use		Noise level (dB(A))	Heat dissipation (W)	Air flow (m ³ /h)
		I_N (A)	I_{max} (A)	P_N (kW)	I_{Ld} (A)	P_{Ld} (kW)	I_{Hd} (A)	P_{Hd} (kW)			
ACS880-14-0320A-7	R8i + BLCL-13-7 + R8i	320	480	315	307	250	239	200	75	16000	3760
ACS880-14-0390A-7	R8i + BLCL-13-7 + R8i	390	590	355	374	355	292	250	75	19000	3760
ACS880-14-0580A-7	R8i + BLCL-15-7 + R8i	580	870	560	557	500	434	400	75	26000	3760
ACS880-14-0770A-7	2xR8i + BLCL-24-7 + 2xR8i	770	1160	710	739	710	576	560	77	34000	7220
ACS880-14-0950A-7	2xR8i + BLCL-25-7 + 2xR8i	950	1430	900	912	800	711	710	77	40000	7220
ACS880-14-1130A-7	2xR8i + BLCL-25-7 + 2xR8i	1130	1700	1100	1085	1000	845	800	77	48000	7220
ACS880-14-1450A-7	3xR8i + 2xBLCL-24-7 + 3xR8i	1450	2180	1400	1392	1300	1085	1000	78	63000	11580
ACS880-14-1680A-7	3xR8i + 2xBLCL-24-7 + 3xR8i	1680	2520	1600	1613	1500	1257	1200	78	74000	11580
ACS880-14-2230A-7	4xR8i + 2xBLCL-25-7 + 4xR8i	2230	3350	2200	2141	2000	1668	1600	79	95000	14440



Local ACS880 1400.0 Rpm
Save money
Save energy
Save nerves
Exit Save all
Select

Stop

Loc/Rem

Start



?

Ultra-low harmonic drive modules

ACS880-31+P940 and ACS880-34

Harmonic distortions can disturb or even damage sensitive equipment connected in the same environment. Harmonics also cause additional losses in the network.

The ACS880-31+P940 and ACS880-34 frame R11 is a compact, complete drive module with harmonics mitigation built-in. For high power solutions ABB offering includes ACS880-34 single drive module packages. The package consists of an active supply unit with a harmonic line filter and of a separate inverter unit. R8i modules are utilized in both units, and the packages are ready-dimensioned.

Clean supply network

Our ultra-low harmonic drive produces exceptionally low harmonic content and exceeds the requirements of harmonic recommendations like IEEE 519 and G5/4. Compared to a conventional drive, the harmonic content is reduced by up to 97%. The total harmonic current distortion is typically <3% in nominal situation and undistorted network.

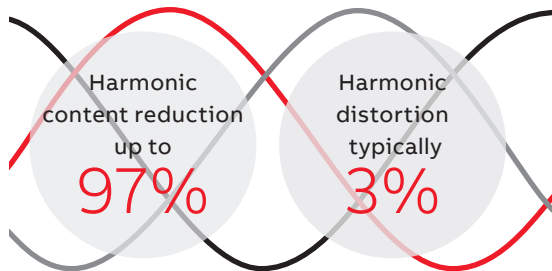

Minimized downtime

ABB's ultra-low harmonic drive offers immunity to network disturbances. The drive will not interrupt the process or affect its quality in unstable supply network conditions. Drives' active supply unit is able to boost the output voltage to enable full motor voltage even when the supply voltage is below nominal. This ensures reliable operation in weak networks. This voltage boost capability can also be utilized to overcome voltage drops caused by long supply or motor cables.

The possibility to stabilize the output voltage of the drive is an advantage compared to alternative low harmonic solutions where voltage cannot be boosted.

Optimized cost and space

The compact ACS880 low harmonic drive solution has harmonics mitigation built-in. This includes an active supply unit and low harmonic line filter. Thus there is no need for external filters, multi-pulse arrangements or special transformers. The simple installation offers significant savings in space, time and cost.

As the risk of overheating is lower with lower harmonic currents, there is no need to over-dimension equipment, such as transformers and cables.

The drive's voltage boost capability can be an advantage in motor dimensioning. With a higher motor voltage, the same power is achieved with less current, which improves motor efficiency and may allow a smaller motor to be used.

Maximized motor performance and efficiency

The drive is able to provide full motor voltage even if the supply voltage fluctuates. It features direct torque control (DTC) as standard, making it suitable also for very demanding applications. DTC provides precise speed and torque control for maximum motor performance and motor efficiency.

—
Keeps the network clean

Efficient energy utilization

Ultra-low harmonic drives achieve a unity power factor. This high power factor indicates that electrical energy is used efficiently.

The drive offers the possibility for network power factor correction to compensate for low power factors of equipment connected to the same network. It can help to avoid penalty charges set by electrical utilities for poor power factors.

Lower harmonics and full motor voltage at all times means reduced system losses and better overall system efficiency.

For more information, visit <https://new.abb.com/drives/harmonics>.

— 01 ACS880-31+P940

— 02 ACS880-34
frame size R11

— 03 ACS880-34 drive
module package,
BLCL line filter and
R8i modules



— 01



— 02



— 03

Ultra-low harmonic single drive modules, ACS880-31+P940 and ACS880-34 frame R11

- Power ratings: 2.2 to 400 kW
- Enclosure classes: IP20, in flange mounting (ACS880-31) heat sink side IP55

Main options:

- Flange mounting
- C2 and C3 EMC filters, see page 74
- I/O extension modules, see page 68
- Communication protocol adapters, see page 68
- Speed feedback interfaces, see page 69
- Functional safety modules, see page 72
- Remote monitoring options, see page 70
- Application specific software, see page 16
- Du/dt filters, see page 88
- Sine filters, see page 76

Ultra-low harmonic single drive module package, ACS880-34, BLCL line filter and R8i frames

- Power ratings: 160 to 2200 kW
- Enclosure class: IP00
- External control unit
- Speed controlled cooling fans in R8i modules. Direct-on-line fans in BLCL filters.
- Internal du/dt filters in R8i modules

Main options:

- C2 EMC filters, see page 74
- I/O extension modules, see page 68
- Communication protocol adapters, see page 68
- Speed feedback interfaces, see page 69
- Functional safety modules, see page 72
- Remote monitoring options, see page 70
- Application specific software, see page 16
- Internal heaters in R8i and BLCL modules
- Direct-on-line cooling fans

The drives have an extensive selection of built-in features and options. See page 98.

Highlights

- The total harmonic current distortion is typically <3% in nominal situation and undistorted network. Low harmonic content also at partial loads
- No need for external filters, multi-pulse arrangements or special transformers
- Simple and cost-effective installation
- Unity power factor. Possibility for network power factor correction
- Small installation footprint
- Output voltage stabilization secures operation in weak networks
- Mechanical installation kits for easy engineering and assembly of module packages
- Possibility for flange (push through) mounting up to frame R11.

Ratings, types and voltages

Wall-mounted ultra-low harmonic drives, ACS880-31

$U_N = 400\text{ V}$ (range 380 to 415 V). The power ratings are valid at nominal voltage 400 V (3 to 110 kW).

Drive type	Frame size	Nominal ratings			Light overload use		Heavy-duty use		Noise level (dB(A))	Heat dissipation (W)	Air flow (m ³ /h)
		I_N (A)	I_{MAX} (A)	P_N (kW)	I_{Ld} (A)	P_{Ld} (kW)	I_{Hd} (A)	P_{Hd} (kW)			
ACS880-31-09A4-3	R3	10	13.6	4	9.5	4	8	3	57	226	361
ACS880-31-12A6-3	R3	12.9	17	5.5	12	5.5	10	4	57	329	361
ACS880-31-017A-3	R3	17	21.9	7.5	16	7.5	12.9	5.4	57	395	361
ACS880-31-025A-3	R3	25	28.8	11	24	11	17	7.5	57	579	361
ACS880-31-032A-3	R6	32	42.5	15	30	15	25	11	71	625	550
ACS880-31-038A-3	R6	38	54.4	18.5	36	18.5	32	15	71	751	550
ACS880-31-045A-3	R6	45	64.6	22	43	22	38	18.5	71	912	550
ACS880-31-061A-3	R6	61	76.5	30	58	30	45	22	71	1088	550
ACS880-31-072A-3	R6	72	103.7	37	68	37	61	30	71	1502	550
ACS880-31-087A-3	R6	87	122.4	45	83	45	72	37	71	1904	550
ACS880-31-105A-3	R8	105	148	55	100	55	87	45	68	1877	700
ACS880-31-145A-3	R8	145	178.3	75	138	75	105	55	68	2963	700
ACS880-31-169A-3	R8	169	246.5	90	161	90	145	75	68	3168	700
ACS880-31-206A-3	R8	206	287.3	110	196	110	169	90	68	3990	805

$U_N = 500\text{ V}$ (range 380 to 500 V). The power ratings are valid at nominal voltage 500 V (2.2 to 110 kW).

Drive type	Frame size	Nominal ratings			Light overload use		Heavy-duty use		Noise level (dB(A))	Heat dissipation (W)	Air flow (m ³ /h)
		I_N (A)	I_{MAX} (A)	P_N (kW)	I_{Ld} (A)	P_{Ld} (kW)	I_{Hd} (A)	P_{Hd} (kW)			
ACS880-31-07A6-5	R3	7.6	9.5	4	7.2	4	5.2	2.2	57	219	361
ACS880-31-11A0-5	R3	11	13.8	5.5	10.4	5.5	7.6	4	57	278	361
ACS880-31-014A-5	R3	14	18.7	7.5	13	7.5	11	5.5	57	321	361
ACS880-31-021A-5	R3	21	26.3	11	19	11	14	7.5	57	473	361
ACS880-31-027A-5	R6	27	35.7	15	26	15	21	11	71	625	550
ACS880-31-034A-5	R6	34	45.9	18.5	32	18.5	27	15	71	711	550
ACS880-31-040A-5	R6	40	57.8	22	38	22	34	18.5	71	807	550
ACS880-31-052A-5	R6	52	68	30	49	30	40	22	71	960	550
ACS880-31-065A-5	R6	65	88.4	37	62	37	52	30	71	1223	550
ACS880-31-077A-5	R6	77	110.5	45	73	45	65	37	71	1560	550
ACS880-31-101A-5	R8	101	148	55	91	55	77	45	68	1995	700
ACS880-31-124A-5	R8	124	178	75	118	75	96	55	68	2800	700
ACS880-31-156A-5	R8	156	247	90	148	90	124	75	68	3168	700
ACS880-31-180A-5	R8	180	287	110	171	110	156	90	68	3872	805

Nominal ratings

I_N Rated current available continuously without overloadability at 40 °C.

P_N Typical motor power in no-overload use.

Maximum output current

I_{max} Maximum output current. Available for 10 seconds at start, then as long as allowed by drive temperature.

Light-overload use

I_{Ld} Continuous current allowing 110% I_{Ld} for 1 minute every 5 minutes at 40 °C.

P_{Ld} Typical motor power in light-overload use.

Heavy-duty use

I_{Hd} Continuous current allowing 150% I_{Hd} for 1 minute every 5 minutes at 40 °C.

P_{Hd} Typical motor power in heavy-duty use.

The ratings apply at 40 °C ambient temperature.

At higher temperatures (up to 55 °C) the derating is 1%/1 °C.

Ratings, types and voltages

Ultra-low harmonic drive modules, ACS880-34 R11

$U_N = 400\text{ V}$ (range 380 to 415 V). The power ratings are valid at nominal voltage 400 V (110 to 355 kW).

Drive type	Frame size	Nominal ratings			Light overload use		Heavy-duty use		Noise level (dB(A))	Heat dissipation (W)	Air flow (m ³ /h)
		I_N (A)	I_{max} (A)	P_N (kW)	I_{Ld} (A)	P_{Ld} (kW)	I_{Hd} (A)	P_{Hd} (kW)			
ACS880-34-246A-3	R11	246	350	132	234	132	206	110	75	5280	2100
ACS880-34-293A-3	R11	293	418	160	278	160	246	132	75	6400	2100
ACS880-34-363A-3	R11	363	498	200	345	200	293	160	75	8000	2100
ACS880-34-442A-3	R11	442	545	250	420	250	363	200	75	10000	2100
ACS880-34-505A-3	R11	505	560	250	480	250	363	200	75	10000	2100
ACS880-34-585A-3	R11	585	730	315	556	315	442	250	75	12600	2100
ACS880-34-650A-3	R11	650	730	355	618	355	505	250	75	14200	2100

$U_N = 500\text{ V}$ (range 380 to 500 V). The power ratings are valid at nominal voltage 500 V (110 to 355 kW).

Drive type	Frame size	Nominal ratings			Light overload use		Heavy-duty use		Noise level (dB(A))	Heat dissipation (W)	Air flow (m ³ /h)
		I_N (A)	I_{max} (A)	P_N (kW)	I_{Ld} (A)	P_{Ld} (kW)	I_{Hd} (A)	P_{Hd} (kW)			
ACS880-34-240A-5	R11	240	350	132	228	132	180	110	75	5280	2100
ACS880-34-260A-5	R11	260	418	160	247	160	240	132	75	6400	2100
ACS880-34-361A-5	R11	361	542	200	343	200	260	160	75	8000	2100
ACS880-34-414A-5	R11	414	542	250	393	250	361	200	75	10000	2100
ACS880-34-460A-5	R11	460	560	315	450	315	414	250	75	12600	2100
ACS880-34-503A-5	R11	503	560	355	492	355	460	315	75	14200	2100

$U_N = 690\text{ V}$ (range 525 to 690 V). The power ratings are valid at nominal voltage 690 V (110 to 400 kW).

Drive type	Frame size	Nominal ratings			Light overload use		Heavy-duty use		Noise level (dB(A))	Heat dissipation (W)	Air flow (m ³ /h)
		I_N (A)	I_{max} (A)	P_N (kW)	I_{Ld} (A)	P_{Ld} (kW)	I_{Hd} (A)	P_{Hd} (kW)			
ACS880-34-142A-7	R11	142	250	132	135	132	119	110	75	5280	2100
ACS880-34-174A-7	R11	174	274	160	165	160	142	132	75	6400	2100
ACS880-34-210A-7	R11	210	384	200	200	200	174	160	75	8000	2100
ACS880-34-271A-7	R11	271	411	250	257	250	210	200	75	10000	2100
ACS880-34-330A-7	R11	330	480	315	320	315	271	250	75	12600	2100
ACS880-34-370A-7	R11	370	520	355	360	355	330	315	75	14200	2100
ACS880-34-430A-7	R11	430	520	400	420	400	370	355	75	16000	2100

Ratings, types and voltages

Ultra-low harmonic module packages

ACS880-34

$U_N = 400\text{ V}$ (range 380 to 415 V). The power ratings are valid at nominal voltage 400 V (160 to 1400 kW).

Drive type	Frame size	Nominal ratings			Light overload use		Heavy-duty use		Noise level (dB(A))	Heat dissipation (W)	Air flow (m ³ /h)
		I_N (A)	I_{max} (A)	P_N (kW)	I_{Ld} (A)	P_{Ld} (kW)	I_{Hd} (A)	P_{Hd} (kW)			
ACS880-34-0450A-3	R8i + BLCL-13-5 + R8i	450	590	250	432	200	337	160	75	14000	3760
ACS880-34-0620A-3	R8i + BLCL-13-5 + R8i	620	810	355	595	315	464	250	75	18000	3760
ACS880-34-0870A-3	R8i + BLCL-15-5 + R8i	870	1140	500	835	450	651	355	75	27000	3760
ACS880-34-1210A-3	2xR8i + BLCL-24-5 + 2xR8i	1210	1580	710	1162	630	905	500	77	34000	7220
ACS880-34-1430A-3	2xR8i + BLCL-24-5 + 2xR8i	1430	1860	800	1373	710	1070	560	77	38000	7220
ACS880-34-1700A-3	2xR8i + BLCL-25-5 + 2xR8i	1700	2210	1000	1632	900	1272	710	77	51000	7220
ACS880-34-2060A-3	3xR8i + 2xBLCL-24-5 + 3xR8i	2060	2680	1200	1978	1100	1541	800	78	61000	11580
ACS880-34-2530A-3	3xR8i + 2xBLCL-24-5 + 3xR8i	2530	3290	1400	2429	1200	1892	1000	78	76000	11580

$U_N = 500\text{ V}$ (range 380 to 500 V). The power ratings are valid at nominal voltage 500 V (200 to 1600 kW).

Drive type	Frame size	Nominal ratings			Light overload use		Heavy-duty use		Noise level (dB(A))	Heat dissipation (W)	Air flow (m ³ /h)
		I_N (A)	I_{max} (A)	P_N (kW)	I_{Ld} (A)	P_{Ld} (kW)	I_{Hd} (A)	P_{Hd} (kW)			
ACS880-34-0420A-5	R8i + BLCL-13-5 + R8i	420	550	250	403	250	314	200	75	13000	3760
ACS880-34-0570A-5	R8i + BLCL-13-5 + R8i	570	750	400	547	355	426	250	75	17000	3760
ACS880-34-0780A-5	R8i + BLCL-15-5 + R8i	780	1020	560	749	500	583	400	75	25000	3760
ACS880-34-1110A-5	2xR8i + BLCL-24-5 + 2xR8i	1110	1450	800	1066	710	830	560	77	32000	7220
ACS880-34-1530A-5	2xR8i + BLCL-25-5 + 2xR8i	1530	1990	1100	1469	1000	1144	800	77	46000	7220
ACS880-34-1980A-5	3xR8i + 2xBLCL-24-5 + 3xR8i	1980	2580	1400	1901	1300	1481	1000	78	59000	11580
ACS880-34-2270A-5	3xR8i + 2xBLCL-24-5 + 3xR8i	2270	2960	1600	2179	1500	1698	1200	78	69000	11580

$U_N = 690\text{ V}$ (range 525 to 690 V). The power ratings are valid at nominal voltage 690 V (200 to 2200 kW).

Drive type	Frame size	Nominal ratings			Light overload use		Heavy-duty use		Noise level (dB(A))	Heat dissipation (W)	Air flow (m ³ /h)
		I_N (A)	I_{max} (A)	P_N (kW)	I_{Ld} (A)	P_{Ld} (kW)	I_{Hd} (A)	P_{Hd} (kW)			
ACS880-34-0320A-7	R8i + BLCL-13-7 + R8i	320	480	315	307	250	239	200	75	16000	3760
ACS880-34-0390A-7	R8i + BLCL-13-7 + R8i	390	590	355	374	355	292	250	75	19000	3760
ACS880-34-0580A-7	R8i + BLCL-15-7 + R8i	580	870	560	557	500	434	400	75	26000	3760
ACS880-34-0770A-7	2xR8i + BLCL-24-7 + 2xR8i	770	1160	710	739	710	576	560	77	34000	7220
ACS880-34-0950A-7	2xR8i + BLCL-25-7 + 2xR8i	950	1430	900	912	800	711	710	77	40000	7220
ACS880-34-1130A-7	2xR8i + BLCL-25-7 + 2xR8i	1130	1700	1100	1085	1000	845	800	77	48000	7220
ACS880-34-1450A-7	3xR8i + 2xBLCL-24-7 + 3xR8i	1450	2180	1400	1392	1300	1085	1000	78	63000	11580
ACS880-34-1680A-7	3xR8i + 2xBLCL-24-7 + 3xR8i	1680	2520	1600	1613	1500	1257	1200	78	74000	11580
ACS880-34-2230A-7	4xR8i + 2xBLCL-25-7 + 4xR8i	2230	3350	2200	2141	2000	1668	1600	79	95000	14440

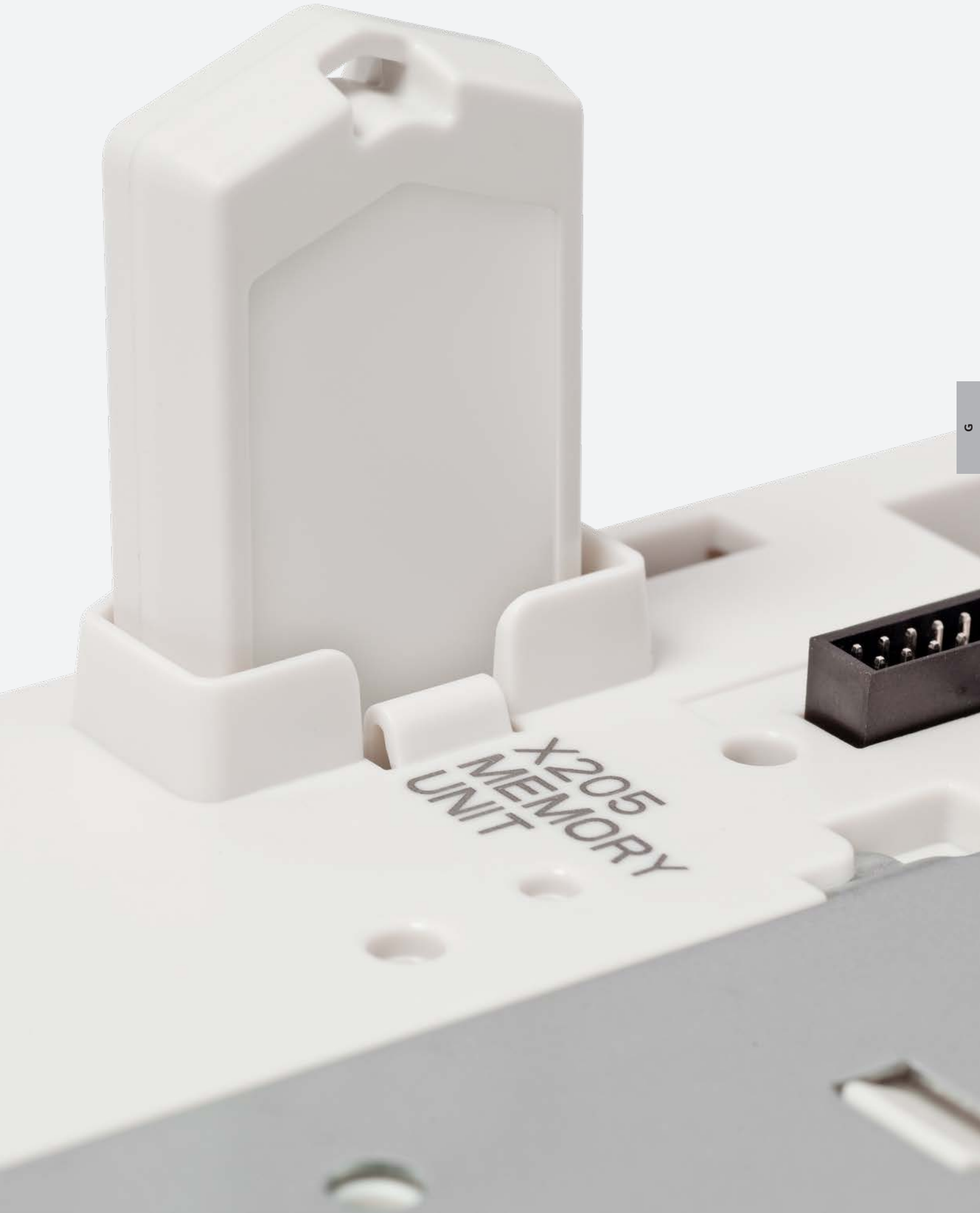

G

Multidrive modules

ACS880-X04

The module selection for building multidrive configurations includes inverter, diode supply, IGBT supply, regenerative rectifier, brake and DC-DC converter units. Their modular design and side-by-side mounting make installation fast and easy. Modules with bigger frame sizes are equipped with wheels so they can easily be moved in or out of the cabinet for maintenance purposes. This concept also allows pre-installation of the power cables inside the empty cabinet.

Multidrive can be used wherever several motors form part of a single process. With a compact module design and high power density, the single supply and DC bus arrangement with multiple inverters provides many advantages:

- Savings in cabling, installation and maintenance costs
- Reduced component count and increased reliability
- Reduced line power and line currents. As the energy circulates over the common DC bus, all energy is not taken from the supply network. Energy circulation can be used for motor-to-motor braking without the need for a braking chopper or regenerative supply unit.

Inverter units (INU)

Inverter units are DC supplied and have built-in capacitors for smoothing the DC voltage. The electrical connection to the common DC bus is fuse protected. An optional switch can be selected to disconnect the whole drive unit from the DC bus.

Diode supply units (DSU)

A diode supply unit is used in non-regenerative drive systems to convert three-phase AC voltage to DC voltage. Two types of diode supply unit are available: an uncontrolled 6-pulse diode supply unit (D6D to D8D) and a half-controlled diode supply unit with thyristor charging (D7T and D8T). The DXT modules can be connected parallel and are able to charge the inverters without external components.

IGBT supply units (ISU)

IGBT supply units are used in regenerative drives to convert three-phase AC voltage to DC voltage. The units provide the same features as ACS880-11/14 regenerative drives.

The ISU consists of RXi and LCL filter modules. It can operate in both motoring and generating modes. The DC voltage is constant and the line current is sinusoidal. The control also provides a near unity power factor. The supply unit can also boost DC voltage e.g. when line voltage is low. Harmonic content remains extremely low due to DTC control and LCL line filtering.

Regenerative rectifier unit (RRU)

This supply unit is used in regenerative drive systems to convert three-phase AC voltage to DC voltage. The RRU consists of R8i and L filter modules. During motoring the input current flows through the diodes to the DC bus and the supply unit works as a diode bridge. In regeneration the current flows from the DC bus through the IGBTs to the supply network. The IGBTs' are switched to conduct only once during each network voltage cycle. This reduces switching losses and enables high input and output powers of the R8i module. Unlike with a thyristor bridge, the IGBTs can be switched off at any time which improves reliability.

Brake unit

Brake unit is used for resistor braking. It handles the energy generated by decelerating motors for example in emergency stopping. Whenever the voltage in the common DC bus exceeds a certain limit, a braking chopper connects the bus to a braking resistor.

DC/DC converter (DDC)

This converter can transfer energy from a common DC bus of a drive system into an external energy storage. From there it can transfer the energy back to the DC bus when needed. Energy storages can be batteries or super capacitors. Applications for energy storage and reuse are found in a range of industries, such as marine (heave and peak load compensation), process industry (electrical braking or DC bus voltage stabilization) and automotive (charging systems). The converter unit consists of R8i and DCL filter modules.

—
01 Multidrive configuration with supply unit, DC bus and multiple inverters
—
02 ACS880-104 inverters modules, frame sizes R1i to R8i

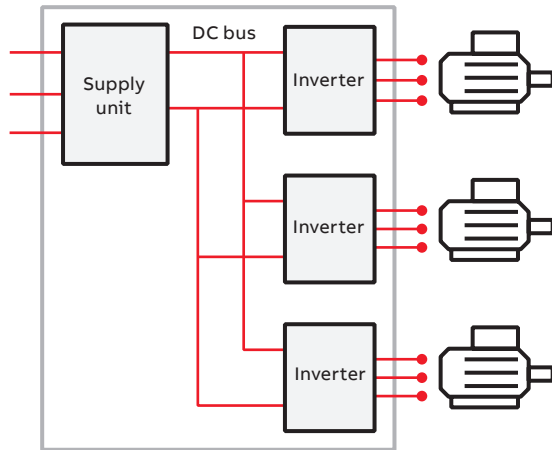

01



02

Multidrive modules, ACS880-X04

- Power ratings:
 - Inverter units (INU): 1.5 to 3200 kW
 - Diode supply units (DSU): 55 to 5445 kVA
 - IGBT supply units (ISU): 5.5 to 3679 kVA
 - Regenerative rectifier units (RRU): 416 to 4135 kVA
 - Brake units: 1-phase P_{cont} 70 to 714 kW, 3-phase P_{cont} 500 to 6500 kW
 - DC-DC converters (DDC): 305 to 1146 kW
- Voltage range: 380 to 690 V
- Enclosure class: IP00
- All multidrive modules come with a control unit. The same control units are used with all ACS880 drives. They have three option slots for option modules, such as I/O extension and communication protocol adapters.

Main options:

- Detailed documentation for cabinet installation
- Cabinet accessory kits
- Marine type approvals
- I/O extension modules, see page 68
- Communication protocol adapters, see page 68
- Application specific softwares, see page 16
- Speed feedback interfaces, see page 69
- Remote monitoring options, see page 70
- Functional safety modules, see page 72
- Brake choppers and resistors, see page 80
- Du/dt filters, see page 88

The drives have an extensive selection of built-in features and options. See page 102.

Highlights

- Compact design for easy cabinet assembly and maintenance
- High power density
- Multidrive concept with one supply unit and DC bus arrangement with multiple inverters which reduces line power, cabinet size and investment costs
- Mechanical and electrical accessories which provide full design to install the modules into Rittal VX25 cabinets

Liquid-cooled multidrive modules

ACS880-x04LC, ACS880-1007LC/1604LC

The compact and robust ACS880 liquid-cooled drive modules with direct liquid cooling are an ultimate solution for various applications where space savings, silent operation or durability in harsh environments is a must.

Advanced liquid cooling and compact design

Liquid cooling offers easy heat transfer without air filtering problems. Since the coolant takes care of 98% of the heat losses, no additional filtered air cooling is needed. This increases the total efficiency of the drive installation.

The ACS880 liquid-cooled modules have high power density making their design extremely compact. The small footprint enables significant space and weight reduction.

—
Optimal for harsh environmental conditions

Optimal solution for different environments

The possibility to have totally enclosed cabinet structure makes the ACS880 liquid-cooled modules perfect for harsh environmental conditions. The modules can even be integrated into explosion-proof enclosures for installations in hazardous locations.

The ACS880 liquid-cooled offering fulfills marine and offshore requirements. The modules have marine type approvals from various key classification bodies.

As the direct liquid cooling enables silent operation, the ACS880 liquid-cooled modules are suitable for applications where noise levels are an important environmental factor.

Simple and cost-efficient installation

The high-efficient liquid cooling removes the need for air-conditioning in the installation rooms, bringing the installation and operation costs down. As there is no need for additional air conditioning devices or air ducts, the installation is significantly simplified.

The used coolant type is Antifrogen® L, by Clariant International Ltd, cooling liquid with glycol and inhibitor. It is a ready-made, commercially available mix, which enables easy commissioning and prevents the risk of errors in coolant selection.

—
Robust, reliable and compact

Wide selection of drive module products

Covering a wide power range with very small footprint, the liquid-cooled ACS880 is available for single and multidrive purposes. The product family includes compact diode supply, IGBT supply, inverter units and DC/DC converters. Optional stand-alone liquid cooling units are offered for cooling the modules. All piping and heat exchangers can be combined to the same closed-loop cooling system.

In addition ABB offers an extensive selection of electrical and mechanical installation accessories including piping components. These minimize cabinet engineering and assembly effort and ensure a safe, tested cabinet design.

—
01 ACS880-304LC
diode supply module,
frame D8D

—
02 ACS880-104LC
inverter module, frame
R8i. The same module
is used in -204LC IGBT
supply and -1604LC
DC/DC converter units.

—
03 ACS880-1007LC
liquid cooling unit,
70 kW



01



02



03

Liquid-cooled modules, ACS880-X04LC

- Power ratings:
 - Diode supply units (DSU): 745 to 3466 kW
 - IGBT supply units (ISU): 430 to 3502 kVA
 - Inverter units (INU): 250 to 3000 kW
 - Brake choppers: 54 to 714 kW
 - DC/DC converters: 400 to 1800 A
- Enclosure class: IP00
- 3-phase inverter modules with internal du/dt filters as standard
- Quick connectors for motor cable output connection

Main options:

- Support for 6/12/24-pulse network configurations
- Electrical and mechanical installation accessories including piping components – full design for Rittal VX25 cabinet installations
- Wide selection of ACS880 options

Liquid cooling unit, ACS880-1007LC

- Power ratings: 70 to 195 kW cooling power
- Enclosure class: IP54
- Stand-alone cabinet with cooling pipe connections on the right side
- Built-in cabinet heater
- Heat exchanger for industrial cooling water
- Fulfills marine requirements

Main options:

- Single pump and two pump versions
- Redundant pump version
- Different piping solutions and sea water heat exchanger available as engineered variants

The drives have an extensive selection of built-in features and options. See page 102.

Highlights

- Advanced liquid cooling which reduces the need for air cooling in installation rooms
- High power density with compact design
- Optimized design for cabinet assembly
- Silent operation
- Suitable for harsh environments
- Marine approvals from various key classification bodies

Ratings, types and voltages

Inverter units, air-cooled, ACS880-104, 400 V

$U_N = 400$ V (range 380 to 415 V). The power ratings are valid at nominal voltage 400 V (1.5 to 2800 kW).

Drive type	Frame size	Nominal ratings			Light overload use		Heavy-duty use		Noise level (dB(A))	Heat dissipation (kW)	Air flow (m ³ /h)
		I_N AC (A)	I_{max} AC (A)	P_N (kW)	I_{Ld} (A)	P_{Ld} (kW)	I_{Hd} (A)	P_{Hd} (kW)			
Inverter modules (INU), ACS880-104											
ACS880-104-004A8-3	R1i	4.8	7	1.5	4.5	1.5	4	1.5	47	0.07	24
ACS880-104-006A0-3	R1i	6	8.8	2.2	5.5	2.2	5	1.5	47	0.08	24
ACS880-104-008A0-3	R1i	8	10.5	3	7.6	3	6	2.2	47	0.09	24
ACS880-104-0011A-3	R2i	10.5	13.5	4	9.7	4	9	3	39	0.11	48
ACS880-104-0014A-3	R2i	14	16.5	5.5	13	5.5	11	4	39	0.14	48
ACS880-104-0018A-3	R2i	18	21	7.5	16.8	7.5	14	5.5	39	0.17	48
ACS880-104-0025A-3	R3i	25	33	11	23	11	19	7.5	63	0.2	142
ACS880-104-0035A-3	R3i	35	44	15	32	15	29	11	63	0.3	142
ACS880-104-0044A-3	R3i	44	53	18.5	41	18.5	35	15	71	0.35	200
ACS880-104-0050A-3	R3i	50	66	22	46	22	44	22	71	0.41	200
ACS880-104-0061A-3	R4i	61	78	30	57	30	52	22	70	0.5	290
ACS880-104-0078A-3	R4i	78	100	37	74	37	69	30	70	0.6	290
ACS880-104-0094A-3	R4i	94	124	45	90	45	75	37	70	0.74	290
ACS880-104-0100A-3	R4i	104	125	55	100	55	78	37	70	0.75	290
ACS880-104-0140A-3	R6i	141	183	75	135	75	105	55	71	1.1	650
ACS880-104-0170A-3	R6i	169	220	90	162	90	126	55	71	1.4	650
ACS880-104-0210A-3	R6i	206	268	110	198	110	154	75	71	1.8	650
ACS880-104-0250A-3	R6i	246	320	132	236	132	184	90	71	2	650
ACS880-104-0300A-3	R7i	300	390	160	288	160	224	110	72	2.5	940
ACS880-104-0350A-3	R7i	350	455	200	336	160	262	132	72	3.1	940
ACS880-104-0470A-3	R8i	470	620	250	451	250	352	160	72	4.8	1300
ACS880-104-0640A-3	R8i	640	840	355	614	315	479	250	72	6.7	1300
ACS880-104-0760A-3	R8i	760	990	400	730	400	568	315	72	8	1300
ACS880-104-0900A-3	R8i	900	1080	500	864	450	673	355	72	10	1300
ACS880-104-1250A-3	2×R8i	1250	1630	630	1200	630	935	500	74	13	2600
ACS880-104-1480A-3	2×R8i	1480	1930	800	1421	800	1107	630	74	16	2600
ACS880-104-1760A-3	2×R8i	1760	2120	1000	1690	900	1316	710	74	20	2600
ACS880-104-2210A-3	3×R8i	2210	2880	1200	2122	1200	1653	900	76	23	3900
ACS880-104-2610A-3	3×R8i	2610	3140	1400	2506	1400	1952	1000	76	30	3900
ACS880-104-3450A-3	4×R8i	3450	4140	1800	3312	1800	2581	1400	76	40	5200
ACS880-104-4290A-3	5×R8i	4290	5150	2400	4118	2000	3209	1800	77	50	6500
ACS880-104-5130A-3	6×R8i	5130	6160	2800	4925	2400	3837	2000	78	60	7800

Nominal ratings

I_N	Rated current available continuously without overloadability at 40 °C.
S_N	Nominal apparent power.
P_N	Typical motor power in no-overload use.

Maximum output current

I_{max}	Maximum output current. Available for 10 seconds at start, then as long as allowed by drive temperature.
-----------	--

Light-overload use

I_{Ld}	Continuous current allowing 110% I_{Ld} for 1 minute every 5 minutes at 40 °C.
P_{Ld}	Typical motor power in light-overload use.

Heavy-duty use

I_{Hd}	Continuous current allowing 150% I_{Hd} for 1 minute every 5 minutes at 40 °C.
P_{Hd}	Typical motor power in heavy-duty use.

The ratings apply at 40 °C ambient temperature. At higher temperatures (up to 50 °C) the derating is 1%/1 °C.

¹⁾ +A003 Uncontrolled diode bridge, +A018 Half-controlled diode bridge, +A004 12-pulse DSU.

Ratings, types and voltages

Supply units, air-cooled, ACS880-x04, 400 V

$U_N = 400$ V (range 380 to 415 V). The power ratings are valid at nominal voltage 400 V (5.5 to 3788 kVA).

Drive type	Frame size	Nominal ratings				No over-load use		Light overload use		Heavy-duty use		Noise level (dB(A))	Heat dissipation (kW)	Air flow (m ³ /h)
		I_N AC (A)	I_N DC (A)	I_{max} DC (A)	S_N (kVA)	P_N DC (kW)	I_{Ld} DC (A)	P_{Ld} DC (KW)	I_{Hd} DC (A)	P_{Hd} DC (kW)				
IGBT supply modules (ISU), ACS880-204														
ACS880-204-008A0-3	R1i+WFU-01	8	9.7	12.6	5.5	5.5	9.3	5.3	7.3	4.1	47	0.22	24	
ACS880-204-0018A-3	R2i+WFU-02	18	22	28	12	12	21	12	16	9	39	0.5	48	
ACS880-204-0035A-3	R3i+WFU-11	35	42	55	24	24	41	23	32	18	63	0.97	63	
ACS880-204-0050A-3	R3i+WFU-21	50	61	79	35	34	58	33	45	26	71	1.39	200	
ACS880-204-0093A-3	R4i+WFU-22	93	113	147	64	64	108	61	84	48	70	2.58	290	
ACS880-204-0210A-3	R6i+ALCL-05-5	210	255	331	145	144	244	138	190	108	72	4.1	1150	
ACS880-204-0420A-3	R8i+BLCL-13-5	423	513	667	293	290	492	279	384	217	72	9.2	2200	
ACS880-204-0580A-3	R8i+BLCL-13-5	576	698	908	399	395	670	379	522	296	72	12	2200	
ACS880-204-0810A-3	R8i+BLCL-15-5	810	982	1277	561	556	943	533	735	416	72	17.5	2200	
ACS880-204-1130A-3	2×R8i+BLCL-24-5	1125	1364	1773	779	772	1309	741	1020	577	74	21.5	4100	
ACS880-204-1330A-3	2×R8i+BLCL-24-5	1332	1615	2100	923	914	1550	877	1208	683	74	24	4100	
ACS880-204-1580A-3	2×R8i+BLCL-25-5	1584	1921	2497	1097	1086	1844	1043	1437	813	74	31.8	4100	
ACS880-204-2350A-3	3×R8i+2×BLCL-24-5	2349	2848	3703	1627	1611	2734	1547	2130	1205	76	47.1	6900	
ACS880-204-3110A-3	4×R8i+2×BLCL-25-5	3105	3765	4894	2151	2130	3614	2045	2816	1593	76	63.1	8200	
ACS880-204-4620A-3	6×R8i+3×BLCL-25-5	4617	5598	7278	3199	3167	5374	3040	4187	2369	78	94.6	12300	
Regenerative rectifier units (RRU), ACS880-904														
ACS880-904-0600A-3	1xR8i + BL-15-5	600	727	955	416	393	698	377	544	294	72	8.4	2200	
ACS880-904-0900A-3	1xR8i + BL-15-5	900	1091	1433	624	589	1048	566	816	441	72	12.9	2200	
ACS880-904-1180A-3	2xR8i + BL-25-5	1180	1431	1879	818	773	1374	742	1070	578	74	15.7	4100	
ACS880-904-1770A-3	2xR8i + BL-25-5	1770	2146	2818	1226	1159	2060	1113	1605	867	74	25.2	4100	
ACS880-904-2310A-3	4xR8i + 2xBL-25-5	2310	2801	3678	1600	1512	2689	1452	2095	1131	76	31.5	8200	
ACS880-904-3460A-3	4xR8i + 2xBL-25-5	3460	4195	5509	2397	2265	4027	2175	3138	1695	76	50.4	8200	
Diode supply modules (DSU), ACS880-304														
6-pulse diode ¹⁾														
ACS880-304-0080A-3+A003	D6D	80	98	137	55	53	94	51	78	42	62	0.8	370	
ACS880-304-0170A-3+A003	D6D	173	212	297	120	114	203	110	170	92	62	1.3	370	
ACS880-304-0330A-3+A003	D7D	327	400	561	227	216	384	208	320	173	62	2	720	
ACS880-304-0490A-3+A003	D7D	490	600	840	339	324	576	311	480	259	62	3	720	
ACS880-304-0650A-3+A003	D8D	653	800	1120	452	432	768	415	640	345	65	4.5	900	
ACS880-304-0980A-3+A003	D8D	980	1200	1680	679	648	1152	622	960	519	65	6	900	
ACS880-304-0650A-3+A018	D8T	653	800	1120	452	432	768	415	598	323	72	4.6	1300	
ACS880-304-0980A-3+A018	D8T	980	1200	1680	679	648	1152	622	898	485	72	6.6	1300	
ACS880-304-1210A-3+A018	2×D8T	1215	1488	2083	842	804	1428	771	1113	601	74	9.2	2600	
ACS880-304-1820A-3+A018	2×D8T	1823	2232	3125	1263	1205	2143	1157	1670	902	74	13.3	2600	
ACS880-304-2730A-3+A018	3×D8T	2734	3348	4687	1894	1808	3214	1736	2504	1352	76	19.9	3900	
ACS880-304-3640A-3+A018	4×D8T	3645	4464	6250	2525	2411	4285	2314	3339	1803	76	26.6	5200	
ACS880-304-4560A-3+A018	5×D8T	4557	5580	7812	3157	3013	5357	2893	4174	2254	77	33.3	6500	
ACS880-304-5470A-3+A018	6×D8T	5468	6696	9374	3788	3616	6428	3471	5009	2705	78	40	7800	
12-pulse diode ¹⁾														
ACS880-304-0910A-3+A004+A018	2×D7T	912	1116	1562	632	625	1071	600	835	467	74	8.4	1800	
ACS880-304-1210A-3+A004+A018	2×D8T	1215	1488	2083	842	833	1428	800	1113	623	74	9.2	2600	
ACS880-304-1820A-3+A004+A018	2×D8T	1823	2232	3125	1263	1250	2143	1200	1670	935	74	13.3	2600	
ACS880-304-2430A-3+A004+A018	4×D8T	2430	2976	4166	1684	1667	2857	1600	2226	1247	76	18.4	5200	
ACS880-304-3640A-3+A004+A018	4×D8T	3645	4464	6250	2525	2500	4285	2400	3339	1870	76	26.6	5200	
ACS880-304-5470A-3+A004+A018	6×D8T	5468	6696	9374	3788	3750	6428	3600	5009	2805	78	40	7800	

Ratings, types and voltages

Inverter units, air-cooled, ACS880-104, 500 V

$U_N = 500$ V (range 380 to 500 V). The power ratings are valid at nominal voltage 500 V (1.5 to 3200 kW).

Drive type	Frame size	Nominal ratings			Light overload use		Heavy-duty use		Noise level (dB(A))	Heat dissipation (kW)	Air flow (m ³ /h)
		I_N AC (A)	I_{max} AC (A)	P_N (kW)	I_{Ld} (A)	P_{Ld} (kW)	I_{Hd} (A)	P_{Hd} (kW)			
Inverter modules (INU), ACS880-104											
ACS880-104-003A6-5	R1i	3.6	5.3	1.5	3.4	1.5	3	1.5	47	0.06	24
ACS880-104-004A8-5	R1i	4.8	7	2.2	4.5	2.2	4	1.5	47	0.07	24
ACS880-104-006A0-5	R1i	6	8.8	3	5.5	3	5	2.2	47	0.08	24
ACS880-104-008A0-5	R1i	8	10.5	4	7.6	4	6	3	47	0.09	24
ACS880-104-0011A-5	R2i	10.5	13.5	5.5	9.7	5.5	9	4	39	0.13	48
ACS880-104-0014A-5	R2i	14	16.5	7.5	13	7.5	11	5.5	39	0.15	48
ACS880-104-0018A-5	R2i	18	21	11	16.8	11	14	7.5	39	0.18	48
ACS880-104-0025A-5	R3i	25	33	15	23	15	19	11	63	0.23	142
ACS880-104-0030A-5	R3i	30	36	18.5	28	18.5	24	15	63	0.28	142
ACS880-104-0035A-5	R3i	35	44	22	32	22	29	18.5	63	0.32	142
ACS880-104-0050A-5	R3i	50	66	30	46	30	44	22	71	0.48	200
ACS880-104-0061A-5	R4i	61	78	37	57	37	52	30	70	0.55	290
ACS880-104-0078A-5	R4i	78	100	45	74	45	69	45	70	0.65	290
ACS880-104-0094A-5	R4i	94	124	55	90	55	75	45	70	0.8	290
ACS880-104-0110A-5	R6i	113	147	75	108	75	85	55	71	1	650
ACS880-104-0140A-5	R6i	136	177	90	131	90	102	55	71	1.2	650
ACS880-104-0170A-5	R6i	165	215	110	158	110	123	75	71	1.5	650
ACS880-104-0200A-5	R6i	197	256	132	189	132	147	90	71	1.8	650
ACS880-104-0240A-5	R6i	240	312	160	230	160	180	110	71	2	650
ACS880-104-0300A-5	R7i	302	393	200	290	200	226	132	72	2.7	940
ACS880-104-0340A-5	R7i	340	442	250	326	200	254	160	72	3.2	940
ACS880-104-0440A-5	R8i	440	580	250	422	250	329	200	72	4.7	1300
ACS880-104-0590A-5	R8i	590	770	400	566	355	441	250	72	6.3	1300
ACS880-104-0740A-5	R8i	740	970	500	710	450	554	355	72	8.1	1300
ACS880-104-0810A-5	R8i	810	1060	560	778	500	606	400	72	9.3	1300
ACS880-104-1150A-5	2×R8i	1150	1500	800	1104	710	860	560	74	12	2600
ACS880-104-1450A-5	2×R8i	1450	1890	1000	1392	900	1085	710	74	16	2600
ACS880-104-1580A-5	2×R8i	1580	2060	1100	1517	1000	1182	800	74	18	2600
ACS880-104-2150A-5	3×R8i	2150	2800	1500	2064	1400	1608	1100	76	24	3900
ACS880-104-2350A-5	3×R8i	2350	3060	1600	2256	1500	1758	1200	76	27	3900
ACS880-104-3110A-5	4×R8i	3110	4050	2000	2986	2000	2326	1600	76	36	5200
ACS880-104-3860A-5	5×R8i	3860	5020	2400	3706	2400	2887	2000	77	44	6500
ACS880-104-4610A-5	6×R8i	4610	6000	3200	4426	2800	3448	2400	78	53	7800

Nominal ratings

I_N	Rated current available continuously without overloadability at 40 °C.
S_N	Nominal apparent power.
P_N	Typical motor power in no-overload use.

Maximum output current

I_{max}	Maximum output current. Available for 10 seconds at start, then as long as allowed by drive temperature.
-----------	--

Light-overload use

I_{Ld}	Continuous current allowing 110% I_{Ld} for 1 minute every 5 minutes at 40 °C.
P_{Ld}	Typical motor power in light-overload use.

Heavy-duty use

I_{Hd}	Continuous current allowing 150% I_{Hd} for 1 minute every 5 minutes at 40 °C.
P_{Hd}	Typical motor power in heavy-duty use.

The ratings apply at 40 °C ambient temperature. At higher temperatures (up to 50 °C) the derating is 1%/1 °C.

¹⁾ +A003 Uncontrolled diode bridge, +A018 Half-controlled diode bridge, +A004 12-pulse DSU.

Ratings, types and voltages

Supply units, air-cooled, ACS880-x04, 500 V

$U_N = 500$ V (range 380 to 500 V). The power ratings are valid at nominal voltage 400 V (5.7 to 4735 kVA).

Drive type	Frame size	Nominal ratings				No over-load use		Light overload use		Heavy-duty use		Noise level (dB(A))	Heat dissipation (kW)	Air flow (m ³ /h)
		I_N AC (A)	I_N DC (A)	I_{max} DC (A)	S_N (kVA)	P_N DC (kW)	I_{Ld} DC (A)	P_{Ld} DC (KW)	I_{Hd} DC (A)	P_{Hd} DC (kW)				
IGBT supply modules (ISU), ACS880-204														
ACS880-204-006A6-5	R1i+WFU-01	6.6	8	10.4	5.7	6	7.7	5.4	6	4.2	47	0.22	24	
ACS880-204-0015A-5	R2i+WFU-02	15	18	24	13	13	17	12	14	10	39	0.5	48	
ACS880-204-0029A-5	R3i+WFU-11	29	35	46	25	25	34	24	26	19	63	0.97	63	
ACS880-204-0041A-5	R3i+WFU-21	41	50	65	35	35	48	34	37	26	71	1.39	200	
ACS880-204-0077A-5	R4i+WFU-22	77	93	121	66	66	90	63	70	49	70	2.58	290	
ACS880-204-0210A-5	R6i+ALCL-05-5	210	255	331	182	180	244	173	190	135	72	4.2	1150	
ACS880-204-0400A-5	R8i+BLCL-13-5	396	480	624	343	340	461	326	359	254	72	9.2	2200	
ACS880-204-0530A-5	R8i+BLCL-13-5	531	644	837	460	455	618	437	482	341	72	11.5	2200	
ACS880-204-0730A-5	R8i+BLCL-15-5	729	884	1149	631	625	849	600	661	468	72	16.7	2200	
ACS880-204-1040A-5	2×R8i+BLCL-24-5	1035	1255	1631	896	887	1205	852	939	664	74	20.8	4100	
ACS880-204-1420A-5	2×R8i+BLCL-25-5	1422	1724	2241	1231	1219	1655	1170	1290	912	74	29.4	4100	
ACS880-204-2120A-5	3×R8i+2×BLCL-24-5	2115	2564	3334	1832	1813	2462	1741	1918	1356	76	43.9	6900	
ACS880-204-2800A-5	4×R8i+2×BLCL-25-5	2799	3394	4412	2424	2400	3258	2304	2539	1795	76	58.5	8200	
ACS880-204-4150A-5	6×R8i+3×BLCL-25-5	4149	5031	6540	3593	3557	4829	3415	3763	2661	78	87.6	12300	
Regenerative rectifier units (RRU), ACS880-904														
ACS880-904-0600A-5	1xR8i + BL-15-5	600	727	955	520	491	698	471	544	367	72	8.5	2200	
ACS880-904-0900A-5	1xR8i + BL-15-5	900	1091	1433	779	737	1047	707	816	551	72	13	2200	
ACS880-904-1180A-5	2xR8i + BL-25-5	1180	1431	1879	1022	966	1374	927	1070	722	74	16.1	4100	
ACS880-904-1770A-5	2xR8i + BL-25-5	1770	2146	2818	1533	1449	2060	1391	1605	1084	74	25.6	4100	
ACS880-904-2310A-5	4xR8i + 2xBL-25-5	2310	2801	3678	2001	1891	2689	1815	2095	1414	76	32.2	8200	
ACS880-904-3460A-5	4xR8i + 2xBL-25-5	3460	4195	5509	2996	2832	4027	2719	3138	2118	76	51.1	8200	
Diode supply modules (DSU), ACS880-304														
6-pulse diode¹⁾														
ACS880-304-0080A-5+A003	D6D	80	98	137	69	66	94	63	78	53	62	0.8	370	
ACS880-304-0170A-5+A003	D6D	173	212	297	150	143	203	137	170	114	62	1.3	370	
ACS880-304-0330A-5+A003	D7D	327	400	561	283	270	384	260	320	216	62	2	720	
ACS880-304-0490A-5+A003	D7D	490	600	840	424	405	576	389	480	324	62	3	720	
ACS880-304-0650A-5+A003	D8D	653	800	1120	566	540	768	518	640	432	65	4.5	900	
ACS880-304-0980A-5+A003	D8D	980	1200	1680	849	810	1152	778	960	648	65	6	900	
ACS880-304-0650A-5+A018	D8T	653	800	1120	566	540	768	518	598	404	72	4.6	1300	
ACS880-304-0980A-5+A018	D8T	980	1200	1680	849	810	1152	778	898	606	72	6.6	1300	
ACS880-304-1210A-5+A018	2×D8T	1215	1488	2083	1052	1004	1428	964	1113	751	74	9.2	2600	
ACS880-304-1820A-5+A018	2×D8T	1823	2232	3125	1579	1507	2143	1446	1670	1127	74	13.3	2600	
ACS880-304-2730A-5+A018	3×D8T	2734	3348	4687	2368	2260	3214	2170	2504	1690	76	19.9	3900	
ACS880-304-3640A-5+A018	4×D8T	3645	4464	6250	3157	3013	4285	2893	3339	2254	76	26.6	5200	
ACS880-304-4560A-5+A018	5×D8T	4557	5580	7812	3946	3767	5357	3616	4174	2817	77	33.3	6500	
ACS880-304-5470A-5+A018	6×D8T	5468	6696	9374	4735	4520	6428	4339	5009	3381	78	40	7800	
12-pulse diode¹⁾														
ACS880-304-0910A-5+A004+A018	2×D7T	912	1116	1562	790	781	1071	750	835	584	74	8.4	1800	
ACS880-304-1210A-5+A004+A018	2×D8T	1215	1488	2083	1052	1042	1428	1000	1113	779	74	9.2	2600	
ACS880-304-1820A-5+A004+A018	2×D8T	1823	2232	3125	1579	1562	2143	1500	1670	1169	74	13.3	2600	
ACS880-304-2430A-5+A004+A018	4×D8T	2430	2976	4166	2104	2083	2857	2000	2226	1558	76	18.4	5200	
ACS880-304-3640A-5+A004+A018	4×D8T	3645	4464	6250	3157	3125	4285	3000	3339	2337	76	26.6	5200	
ACS880-304-5470A-5+A004+A018	6×D8T	5468	6696	9374	4735	4687	6428	4500	5009	3506	78	40	7800	

Ratings, types and voltages

Inverter units, air-cooled, ACS880-104, 690 V

$U_N = 690$ V (range 525 to 690 V). The power ratings are valid at nominal voltage 690 V (4 to 3200 kW).

Drive type	Frame size	Nominal ratings			Light overload use		Heavy-duty use		Noise level (dB(A))	Heat dissipation (kW)	Air flow (m ³ /h)
		I_N AC (A)	I_{max} AC (A)	P_N (kW)	I_{Ld} (A)	P_{Ld} (kW)	I_{Hd} (A)	P_{Hd} (kW)			
Inverter modules (INU), ACS880-104											
ACS880-104-007A3-7	R5i	7.3	9.5	5.5	6.9	5.5	5.6	4	62	0.22	280
ACS880-104-009A8-7	R5i	9.8	12.7	7.5	9.3	7.5	7.3	5.5	62	0.28	280
ACS880-104-014A2-7	R5i	14.2	18.5	11	13.5	11	9.8	7.5	62	0.4	280
ACS880-104-0018A-7	R5i	18	23.4	15	17.1	15	14.2	11	62	0.49	280
ACS880-104-0022A-7	R5i	22	29	18.5	20.9	18.5	18	15	62	0.58	280
ACS880-104-0027A-7	R5i	27	35	22	25.7	22	22	18.5	62	0.66	280
ACS880-104-0035A-7	R5i	35	46	30	33.3	30	27	22	62	0.86	280
ACS880-104-0042A-7	R5i	42	55	37	39.9	37	35	30	62	1	280
ACS880-104-0052A-7	R5i	52	68	45	49.4	45	42	37	62	1.12	280
ACS880-104-0062A-7	R6i	62	81	55	60	55	46	45	71	0.8	650
ACS880-104-0082A-7	R6i	82	107	75	79	75	61	55	71	1.1	650
ACS880-104-0100A-7	R6i	99	129	90	95	90	74	75	71	1.3	650
ACS880-104-0130A-7	R6i	125	163	110	120	110	94	75	71	1.5	650
ACS880-104-0140A-7	R6i	144	187	132	138	132	108	90	71	1.8	650
ACS880-104-0190A-7	R6i	192	250	160	184	160	144	132	71	2.5	650
ACS880-104-0220A-7	R7i	217	282	200	208	200	162	160	72	2.8	940
ACS880-104-0270A-7	R7i	270	351	250	259	250	202	200	72	3.3	940
ACS880-104-0340A-7	R8i	340	510	315	326	250	254	200	72	5.2	1300
ACS880-104-0410A-7	R8i	410	620	400	394	355	307	250	72	6.1	1300
ACS880-104-0530A-7	R8i	530	800	500	509	450	396	355	72	7.9	1300
ACS880-104-0600A-7	R8i	600	900	560	576	560	449	400	72	9	1300
ACS880-104-0800A-7	2×R8i	800	1200	800	768	710	598	560	74	12	2600
ACS880-104-1030A-7	2×R8i	1030	1550	1000	989	900	770	710	74	15	2600
ACS880-104-1170A-7	2×R8i	1170	1760	1100	1123	1000	875	800	74	18	2600
ACS880-104-1540A-7	3×R8i	1540	2310	1400	1478	1400	1152	1100	76	23	3900
ACS880-104-1740A-7	3×R8i	1740	2610	1600	1670	1600	1302	1200	76	26	3900
ACS880-104-2300A-7	4×R8i	2300	3450	2000	2208	2000	1720	1600	76	35	5200
ACS880-104-2860A-7	5×R8i	2860	4290	2800	2746	2400	2139	2000	77	43	6500
ACS880-104-3420A-7	6×R8i	3420	5130	3200	3283	3200	2558	2400	78	52	7800

Nominal ratings

I_N	Rated current available continuously without overloadability at 40 °C.
S_N	Nominal apparent power.
P_N	Typical motor power in no-overload use.

Maximum output current

I_{max}	Maximum output current. Available for 10 seconds at start, then as long as allowed by drive temperature.
-----------	--

Light-overload use

I_{Ld}	Continuous current allowing 110% I_{Ld} for 1 minute every 5 minutes at 40 °C.
P_{Ld}	Typical motor power in light-overload use.

Heavy-duty use

I_{Hd}	Continuous current allowing 150% I_{Hd} for 1 minute every 5 minutes at 40 °C.
P_{Hd}	Typical motor power in heavy-duty use.

The ratings apply at 40 °C ambient temperature. At higher temperatures (up to 50 °C) the derating is 1%/1 °C.

¹⁾ +A018 half-controlled diode bridge, +A004 12-pulse DSU

Ratings, types and voltages

Supply units, air-cooled, ACS880-x04, 690 V

$U_N = 690$ V (range 525 to 690 V). The power ratings are valid at nominal voltage 690 V (366 to 5446 kVA).

Drive type	Frame size	Nominal ratings				No over-load use		Light overload use		Heavy-duty use		Noise level (dB(A))	Heat dissipation (kW)	Air flow (m ³ /h)
		I_N AC (A)	I_N DC (A)	I_{max} DC (A)	S_N (kVA)	P_N DC (kW)	I_{Ld} DC (A)	P_{Ld} DC (kW)	I_{Hd} DC (A)	P_{Hd} DC (kW)				
IGBT supply units (ISU), ACS880-204														
ACS880-204-0310A-7	R8i+BLCL-13-7	306	371	557	366	362	356	348	278	271	72	11.8	2200	
ACS880-204-0370A-7	R8i+BLCL-13-7	369	447	671	441	437	430	419	335	327	72	13.5	2200	
ACS880-204-0540A-7	R8i+BLCL-15-7	540	655	982	645	639	629	613	490	478	72	17.6	2200	
ACS880-204-0720A-7	2×R8i+BLCL-24-7	720	873	1309	860	852	838	818	653	637	74	23.2	4100	
ACS880-204-1050A-7	2×R8i+BLCL-25-7	1053	1277	1915	1258	1246	1226	1196	955	932	74	31.7	4100	
ACS880-204-1570A-7	3×R8i+2×BLCL-24-7	1566	1899	2848	1872	1853	1823	1779	1420	1386	76	49.6	6900	
ACS880-204-2070A-7	4×R8i+2×BLCL-25-7	2070	2510	3765	2474	2449	2409	2351	1877	1832	76	63	8200	
ACS880-204-3080A-7	6×R8i+3×BLCL-25-7	3078	3732	5598	3679	3642	3583	3496	2792	2724	78	94.4	12300	
Regenerative rectifier units (RRU), ACS880-904														
ACS880-904-0600A-7	1xR8i + BL-15-7	600	727	1102	717	678	698	651	544	507	72	9.8	2200	
ACS880-904-0900A-7	1xR8i + BL-15-7	900	1091	1653	1076	1016	1048	976	816	760	72	14.3	2200	
ACS880-904-1180A-7	2xR8i + BL-25-7	1180	1431	2168	1410	1333	1374	1279	1070	997	74	18.5	4100	
ACS880-904-1770A-7	2xR8i + BL-25-7	1770	2146	3252	2115	1999	2060	1919	1605	1495	74	28.1	4100	
ACS880-904-2310A-7	4xR8i + 2xBL-25-7	2310	2801	4244	2761	2609	2689	2505	2095	1952	76	37.1	8200	
ACS880-904-3460A-7	4xR8i + 2xBL-25-7	3460	4195	6356	4135	3908	4027	3752	3138	2923	76	56.2	8200	
Diode supply units (DSU), ACS880-304														
6-pulse diode¹⁾														
ACS880-304-0570A-7+A018	D8T	572	700	980	684	652	672	626	524	488	72	4.5	1300	
ACS880-304-0820A-7+A018	D8T	817	1000	1400	976	932	960	894	748	697	72	5.8	1300	
ACS880-304-1060A-7+A018	2×D8T	1064	1302	1823	1272	1213	1250	1164	974	907	74	9	2600	
ACS880-304-1520A-7+A018	2×D8T	1519	1860	2604	1815	1733	1786	1663	1391	1296	74	12.7	2600	
ACS880-304-2280A-7+A018	3×D8T	2279	2790	3906	2724	2599	2678	2495	2087	1944	76	19.1	3900	
ACS880-304-3040A-7+A018	4×D8T	3038	3720	5208	3631	3465	3571	3327	2783	2592	76	25.5	5200	
ACS880-304-3800A-7+A018	5×D8T	3797	4650	6510	4538	4331	4464	4158	3478	3240	77	32	6500	
ACS880-304-4560A-7+A018	6×D8T	4557	5580	7812	5446	5198	5357	4990	4174	3888	78	38.4	7800	
12-pulse diode¹⁾														
ACS880-304-0760A-7+A004+A018	2×D7T	760	930	1302	908	898	893	862	696	672	74	7.7	1800	
ACS880-304-1060A-7+A004+A018	2×D8T	1064	1302	1823	1272	1258	1250	1207	974	941	74	9	2600	
ACS880-304-1520A-7+A004+A018	2×D8T	1519	1860	2604	1815	1797	1786	1725	1391	1344	74	12.7	2600	
ACS880-304-2130A-7+A004+A018	4×D8T	2127	2604	3646	2542	2515	2500	2415	1948	1882	76	18.1	5200	
ACS880-304-3040A-7+A004+A018	4×D8T	3038	3720	5208	3631	3594	3571	3450	2783	2688	76	25.5	5200	
ACS880-304-4560A-7+A004+A018	6×D8T	4557	5580	7812	5446	5390	5357	5175	4174	4032	78	38.4	7800	

Ratings, types and voltages

DC/DC converter, air-cooled, ACS880-1604

$U_N = 400$ V (range 380 to 415 V). The power ratings are valid at nominal voltage 400 V.

No overload use					Short time overload cycle (10 s/60 s)		Heavy overload cycle (1 min/5 min)		Noise level dB(A)	Heat dissipation (kW)	Air flow (m ³ /h)	Filter type	Converter type	Frame size
I_{dc} input DC (A)	I_{rms} output DC (A)	$P_{contmax}$ (kW)	I_{max} output DC (A)	I_{p2p} (A)	I_{short} time (A)	P_{short} time (kW)	I_{Hd} (A)	P_{Hd} (kW)						
600	600	305	900	22	450	229	510	260	74	5.2	2200	BDCL-14-5	ACS880-1604-0600A-3	R8i
900	900	458	1350	33	675	343	765	389	74	8	2200	BDCL-15-5	ACS880-1604-0900A-3	R8i
1200	1200	611	1800	11	899	458	1020	519	76	10.5	4400	2xBDCL-14-5	ACS880-1604-1200A-3	2xR8i
1800	1800	916	2700	16	1349	687	1529	779	76	16.5	4400	2xBDCL-15-5	ACS880-1604-1800A-3	2xR8i

$U_N = 500$ V (range 380 to 500 V). The power ratings are valid at nominal voltage 500 V.

No overload use					Short time overload cycle (10 s/60 s)		Heavy overload cycle (1 min/5 min)		Noise level dB(A)	Heat dissipation kW	Air flow (m ³ /h)	Filter type	Drive type	Frame size
I_{dc} input DC (A)	I_{rms} output DC (A)	$P_{contmax}$ (kW)	I_{max} output DC (A)	I_{p2p} (A)	I_{short} time (A)	P_{short} time (kW)	I_{Hd} (A)	P_{Hd} (kW)						
600	600	382	900	27	450	286	510	324	74	6	2200	BDCL-14-5	ACS880-1604-0600A-5	R8i
900	900	573	1350	41	675	429	765	487	74	9.1	2200	BDCL-15-5	ACS880-1604-0900A-5	R8i
1200	1200	764	1800	14	899	572	1020	649	76	12.1	4400	2xBDCL-14-5	ACS880-1604-1200A-5	2xR8i
1800	1800	1146	2700	20	1349	859	1529	973	76	18.8	4400	2xBDCL-15-5	ACS880-1604-1800A-5	2xR8i

$U_N = 690$ V (range 525 to 690 V). The power ratings are valid at nominal voltage 690 V.

No overload use					Short time overload cycle (10 s/60 s)		Heavy overload cycle (1 min/5 min)		Noise level dB(A)	Heat dissipation kW	Air flow (m ³ /h)	Filter type	Drive type	Frame size
I_{dc} input DC (A)	I_{rms} output DC (A)	$P_{contmax}$ (kW)	I_{max} output DC (A)	I_{p2p} (A)	I_{short} time (A)	P_{short} time (kW)	I_{Hd} (A)	P_{Hd} (kW)						
400	400	351	600	38	300	263	340	298	74	6.4	2200	BDCL-14-7	ACS880-1604-0400A-7	R8i
600	600	527	900	56	450	395	510	448	74	10.6	2200	BDCL-15-7	ACS880-1604-0600A-7	R8i
800	800	703	1200	19	600	527	680	597	76	12.8	4400	2xBDCL-14-7	ACS880-1604-0800A-7	2xR8i
1200	1200	1054	1800	28	899	790	1020	895	76	21.5	4400	2xBDCL-15-7	ACS880-1604-1200A-7	2xR8i

Ratings

No overload use

I_{dc} input	Maximum continuous input DC current from DC bus
I_{rms} output	Maximum continuous output current to/from energy storage
$P_{contmax}$	Maximum continuous output power to/from energy storage
I_{max} output	Maximum instantaneous output current to/from energy storage
I_{p2p}	Maximum output ripple current to/from energy storage

Short time / heavy overload cycle

I_{short} time	Continuous output current allowing 10 s of I_{max} (DC) every 60 seconds
P_{short} time	Continuous output power allowing 10 s of I_{max} (DC) every 60 seconds
I_{Hd}	Continuous output current allowing overload of 150% I_{hd} for 1 min every 5 min
P_{Hd}	Continuous output power allowing 150% I_{hd} for 1 min every 5 min

Ratings, types and voltages

Inverter units, liquid-cooled, ACS880-104LC, 690 V

$U_N = 690$ V (range 525 to 690 V). The power ratings are valid at nominal voltage 690 V (250 to 3000 kW).

Inverter module type	Frame size	Nominal ratings			Light overload use		Heavy-duty use		Noise level ¹⁾ (dB(A))	Losses ²⁾ P_{loss} (kW)	Coolant flow rate (l/min)
		I_N (A)	I_{max} (A)	P_N (kW)	I_{Ld} (A)	P_{Ld} (kW)	I_{Hd} (A)	P_{Hd} (kW)			
Liquid-cooled inverter units (INU), ACS880-104LC											
ACS880-104LC-0390A-7	R8i	390	590	355	374	355	292	250	63	5.1	16
ACS880-104LC-0430A-7	R8i	430	650	400	413	355	322	250	63	5.6	16
ACS880-104LC-0480A-7	R8i	480	720	450	461	400	359	315	63	6.4	16
ACS880-104LC-0530A-7	R8i	530	800	500	509	450	396	355	63	7.2	16
ACS880-104LC-0600A-7	R8i	600	900	560	576	560	449	400	63	8.2	16
ACS880-104LC-0670A-7	R8i	670	1010	630	643	630	501	450	63	9.4	16
ACS880-104LC-0750A-7	R8i	750	1130	710	720	710	561	500	63	10.8	16
ACS880-104LC-0850A-7	R8i	850	1280	800	816	800	636	560	63	12.7	16
ACS880-104LC-1030A-7	2xR8i	1030	1550	1000	989	900	770	710	66	14	32
ACS880-104LC-1170A-7	2xR8i	1170	1760	1100	1123	1100	875	800	66	16	32
ACS880-104LC-1310A-7	2xR8i	1310	1970	1200	1258	1200	980	900	66	18.4	32
ACS880-104LC-1470A-7	2xR8i	1470	2210	1400	1411	1200	1100	1000	66	21.2	32
ACS880-104LC-1660A-7	2xR8i	1660	2490	1600	1594	1400	1242	1200	66	24.8	32
ACS880-104LC-1940A-7	3xR8i	1940	2910	1800	1862	1800	1451	1400	68	27.2	48
ACS880-104LC-2180A-7	3xR8i	2180	3270	2000	2093	2000	1631	1400	68	31.4	48
ACS880-104LC-2470A-7	3xR8i	2470	3710	2300	2371	2300	1848	1800	68	36.9	48
ACS880-104LC-2880A-7	4xR8i	2880	4320	2700	2765	2700	2154	2000	69	41.5	64
ACS880-104LC-3260A-7	4xR8i	3260	4890	3000	3130	3000	2438	2300	69	48.7	64

Nominal ratings

I_N	Rated current available continuously without overloadability
P_N	Typical motor power in no-overload use
S_N	Nominal apparent (AC) power

Maximum output current

I_{max}	Maximum output current. Available for 10 seconds at start, then as long as allowed by module temperature.
-----------	---

Light-overload use

I_{Ld}	Continuous current allowing 110% I_{Ld} for 1 minute every 5 minutes.
P_{Ld}	Typical motor power in light-overload use.

Heavy-duty use

I_{Hd}	Continuous current allowing 150% I_{Hd} for 1 minute every 5 minutes
P_{Hd}	Typical motor power in heavy-duty use.

Losses

P_{loss}	Power loss conducted to coolant and emitted to air
------------	--

The ratings apply at an ambient air temperature of 45 °C and a coolant temperature of 40 °C.

Ratings, types and voltages

Supply units, liquid-cooled, ACS880-x04LC, 690 V

$U_N = 690$ V (range 525 to 690 V). The power ratings are valid at nominal voltage 690 V (430 to 3663 kVA).

Supply module type	Frame size	Nominal ratings					Light overload use		Heavy-duty use		Noise level ¹⁾ (dB(A))	Losses ²⁾ P_{loss} (kW)	Coolant flow rate ³⁾ (l/min)
		I_N AC (A)	I_N DC (A)	I_{max} DC (A)	S_N (kVA)	P_N DC (kW)	I_{Ld} DC (A)	P_{Ld} DC (kW)	I_{Hd} DC (A)	P_{Hd} DC (kW)			
Liquid-cooled IGBT supply units (ISU), ACS880-204LC													
ACS880-204LC-0360A-7	R8i+BLCL-15LC-7	360	436	655	430	426	419	409	327	319	58	7.2	36
ACS880-204LC-0400A-7	R8i+BLCL-15LC-7	400	485	727	478	473	466	454	363	354	58	8	36
ACS880-204LC-0450A-7	R8i+BLCL-15LC-7	450	546	818	538	532	524	511	408	398	58	9.2	36
ACS880-204LC-0480A-7	R8i+BLCL-15LC-7	480	582	873	574	568	559	545	435	425	58	10.2	36
ACS880-204LC-0560A-7	R8i+BLCL-15LC-7	560	679	1018	669	663	652	636	508	496	58	12.2	36
ACS880-204LC-0620A-7	R8i+BLCL-15LC-7	620	752	1128	741	734	722	704	562	549	58	13.9	36
ACS880-204LC-0700A-7	R8i+BLCL-15LC-7	700	849	1273	837	828	815	795	635	620	58	16.4	36
ACS880-204LC-0770A-7	R8i+BLCL-15LC-7	770	934	1400	920	911	896	875	698	681	58	18.8	36
ACS880-204LC-0930A-7	2xR8i+BLCL-24LC-7	930	1128	1691	1111	1100	1083	1056	843	823	59	18.8	72
ACS880-204LC-1090A-7	2xR8i+BLCL-24LC-7	1090	1322	1982	1303	1290	1269	1238	989	965	59	22.5	72
ACS880-204LC-1180A-7	2xR8i+BLCL-24LC-7	1180	1431	2146	1410	1396	1374	1340	1070	1044	59	25.7	72
ACS880-204LC-1360A-7	2xR8i+BLCL-25LC-7	1360	1649	2473	1625	1609	1583	1545	1233	1204	59	27.8	72
ACS880-204LC-1500A-7	2xR8i+BLCL-25LC-7	1500	1819	2728	1793	1775	1746	1704	1360	1328	59	31.6	72
ACS880-204LC-1800A-7	3xR8i+BLCL-24LC-7	1800	2182	3274	2151	2130	2095	2045	1633	1593	61	35.8	128
ACS880-204LC-2020A-7	3xR8i+BLCL-24LC-7	2020	2449	3674	2414	2390	2351	2294	1832	1788	61	41.8	128
ACS880-204LC-2220A-7	3xR8i+BLCL-24LC-7	2220	2692	4038	2653	2627	2584	2522	2013	1965	61	47.4	128
ACS880-204LC-2670A-7	4xR8i+BLCL-25LC-7	2670	3237	4856	3191	3159	3108	3033	2422	2363	61	53.4	144
ACS880-204LC-2930A-7	4xR8i+BLCL-25LC-7	2930	3553	5329	3502	3467	3411	3328	2657	2593	61	60.5	144

¹⁾ Noise level in a typical cabinet installation.

²⁾ In totally enclosed cabinet 98% of losses are conducted to coolant, 2% to ambient air.

³⁾ Coolant flow rate for the whole supply unit (supply module and filter).

$U_N = 690$ V (range 525 to 690 V). The power ratings are valid at nominal voltage 690 V (430 to 3663 kVA).

Supply module type	Frame size	Nominal ratings					Light overload use		Heavy-duty use		Noise level ⁴⁾ (dB(A))	Losses ⁵⁾ P_{loss} (kW)	Coolant flow rate (l/min)
		I_N AC (A)	I_N DC (A)	I_{max} DC (A)	S_N (kVA)	P_N DC (kW)	I_{Ld} DC (A)	P_{Ld} DC (kW)	I_{Hd} DC (A)	P_{Hd} DC (kW)			
Liquid-cooled diode supply units (DSU), ACS880-304LC⁶⁾													
ACS880-304LC-0820A-7+A019	D8D	820	1000	1500	980	932	960	895	800	745	63	3.5	12
ACS880-304LC-1540A-7+A019	2xD8D	1540	1880	2820	1840	1752	1805	1682	1504	1401	63	6.6	12
ACS880-304LC-2290A-7+A019	3xD8D	2290	2805	4208	2737	2614	2693	2509	2244	2091	63	9.8	24
ACS880-304LC-3040A-7+A019	4xD8D	3040	3720	5580	3633	3466	3571	3328	2976	2773	63	13	24

⁴⁾ Noise level in a typical cabinet installation.

⁵⁾ In totally enclosed cabinet 98% of losses are conducted to coolant, 2% to ambient air.

⁶⁾ Depending on the number of modules, diode supply units can be configured as 6/12/24 -pulse solutions.

Ratings, types and voltages

Stand-alone liquid cooling unit, ACS880-1007LC

Range 380 to 690 V										
Liquid cooling unit type	Nominal ratings			Noise level (dB(A))	Losses				Internal flow ¹⁾ (l/min)	External flow ²⁾ (l/min)
	P_{\max} (kW)	Internal coolant volume (l)	External coolant volume (l)		$P_{\text{loss total}}$ (kW)	$P_{\text{loss coolant}}$ (kW)	$P_{\text{loss air}}$ (kW)	P_{drop} (kPa)		
ACS880-1007LC-0070 ³⁾	70	17	3	55	0.4	0.3	0.1	150	81/107	120
ACS880-1007LC-0195+C140 ^{3)/C141⁴⁾}	195	31/35	8	55	1.3	1.0	0.3	150	270/355	467
ACS880-1007LC-0195+C213 ⁵⁾	195	35	8	57	2.1	1.8	0.3	150	310/415	467

¹⁾ 120 kPa, Antifrogen® L 25%, 40 °C, 50/60 Hz

²⁾ 36 °C water

³⁾ Single pump

⁴⁾ Redundant, one pump running at a time

⁵⁾ Two pumps running

Nominal ratings

P_{\max}	Maximum nominal cooling power
Internal flow	Nominal coolant flow rate from the liquid cooling unit to the drive modules
External flow	Nominal coolant flow rate to the liquid cooling unit from an external cooling circuit

Losses

$P_{\text{loss total}}$	Power loss conducted to coolant and emitted to air
$P_{\text{loss coolant}}$	Power loss conducted to coolant
$P_{\text{loss air}}$	Power loss emitted to air (ambient room)
P_{drop}	Pressure loss in external cooling unit

Ratings, types and voltages

DC/DC converter, liquid-cooled, ACS880-1604LC

$U_N = 690$ V (range 525 to 690 V). The power ratings are valid at nominal voltage 690 V.

No overload use					Short time overload cycle (10 s/60 s)		Heavy overload cycle (1 min/5 min)		Noise level	Losses	Coolant flow rate ¹⁾	Filter type	Converter type	Frame size
I_{dc} input DC (A)	I_{rms} output DC (A)	$P_{contmax}$ (kW)	I_{max} output DC (A)	I_{p2p} (A)	$I_{short\ time}$ (A)	$P_{short\ time}$ (kW)	I_{Hd} (A)	P_{Hd} (kW)	dB(A)	P_{loss} (kW)	(l/min)			
391	400	351	500	38	250	219	302	266	TBD	4.2	36	BDCL-14LC-7	ACS880-1604LC-0400A-7	R8i
490	500	439	625	38	312	274	378	332	TBD	5.3	36	BDCL-14LC-7	ACS880-1604LC-0500A-7	R8i
590	600	527	750	56	375	329	453	398	TBD	6.2	36	BDCL-15LC-7	ACS880-1604LC-0600A-7	R8i
690	700	615	875	56	437	384	529	465	TBD	7.3	36	BDCL-15LC-7	ACS880-1604LC-0700A-7	R8i
790	800	703	1000	56	500	439	605	531	TBD	8.5	36	BDCL-15LC-7	ACS880-1604LC-0800A-7	R8i
880	900	790	1125	56	562	494	680	597	TBD	9.7	36	BDCL-15LC-7	ACS880-1604LC-0900A-7	R8i
980	1000	878	1250	19	625	549	756	664	TBD	11.2	72	2xBDCL-14LC-7	ACS880-1604LC-1000A-7	2xR8i
1180	1200	1054	1500	28	750	658	907	797	TBD	13.6	72	2xBDCL-15LC-7	ACS880-1604LC-1200A-7	2xR8i
1370	1400	1230	1750	28	874	768	1058	929	TBD	16.3	72	2xBDCL-15LC-7	ACS880-1604LC-1400A-7	2xR8i
1570	1600	1405	2000	28	999	878	1209	1062	TBD	19	72	2xBDCL-15LC-7	ACS880-1604LC-1600A-7	2xR8i
1760	1800	1581	2250	28	1124	987	1360	1195	TBD	22	72	2xBDCL-15LC-7	ACS880-1604LC-1800A-7	2xR8i

¹⁾ Coolant flow rate for the whole converter unit (DC/DC converter module and filter)

Ratings

No overload use

I_{dc} input	Maximum continuous input DC current from DC bus
I_{rms} output	Maximum continuous output current to/from energy storage
$P_{contmax}$	Maximum continuous output power to/from energy storage
I_{max} output	Maximum instantaneous output current to/from energy storage
I_{p2p}	Maximum output ripple current to/from energy storage

Short time / heavy overload cycle

$I_{short\ time}$	Continuous output current allowing 10 s of I_{max} (DC) every 60 seconds
$P_{short\ time}$	Continuous output power allowing 10 s of I_{max} (DC) every 60 seconds
I_{Hd}	Continuous output current allowing overload of 150% I_{hd} for 1 min every 5 min
P_{Hd}	Continuous output power allowing 150% I_{hd} for 1 min every 5 min

Losses

P_{loss}	Power loss conducted to coolant and emitted to air
------------	--

Dimensions

ACS880 drive modules

ACS880-01+P940, IP20						
Frame size	Height (mm)	Width (mm)	Depth		Weight	
			+P940 (mm)	+P944 (mm)	+P940 (kg)	+P944 (kg)
R1	376 ¹⁾	155	226	226	6.1	6.5
R2	376 ¹⁾	155	249	249	7.5	7.9
R3	436 ¹⁾	173	261	261	9.6	10.1
R4	563 ¹⁾	203	333	274	17.1	17.8
R5	653 ¹⁾	203	333	274	20.5	21.4
R6	593	252	357	357	38.7	39.5
R7	645	284	365	365	48.0	49.0
R8	724	300	386	386	61.0	62.0
R9	723	380	413	413	86.0	87.0

¹⁾ Comes with main power clamp.

ACS880-04, IP20 (IP00)				
Frame size	Height (mm)	Width (mm)	Depth (mm)	Weight (kg)
R10	1541 ²⁾	350 ²⁾	506	161
R11	1741 ²⁾	350 ²⁾	506	199

²⁾ Without pedestal (+0H354) and without IP20 shrouds and full-size terminals (+0B051+0H371) height is 179 mm less and width 45 mm less. More information from hardware manual.

ACS880-04XT, IP00 (IP20)				
Frame size	Height (mm)	Width (mm)	Depth (mm)	Weight (kg)
R10	1462 (1541 ³⁾)	305 (350 ³⁾)	506 (506 ³⁾)	156 (161 ³⁾)
R11	1662 (1741 ³⁾)	305 (350 ³⁾)	506 (506 ³⁾)	194 (199 ³⁾)

³⁾ With option "IP20 shrouds for covering the input and motor cabling area".

ACS880-04F, IP20 (backside IP55)				
Without IP shrouds (+0B051) and full size output bus bars (+0H371) but with flange.				
Frame size	Height (mm)	Width (mm)	Depth (mm)	Weight (kg)
R11	1647	620	405	219

ACS880-04FXT, IP00 (backside IP55)				
With flange and shrouds.				
Frame size	Height (mm)	Width (mm)	Depth (mm)	Weight (kg)
R11	1733	620	477	224

ACS880-04 module packages nxR8i, IP00				
Frame size	Height (mm)	Width (mm)	Depth (mm)	Weight (kg)
R8i	1397	240	583	125
D7T	1178	170	417	80
D8T	1397	240	584	180

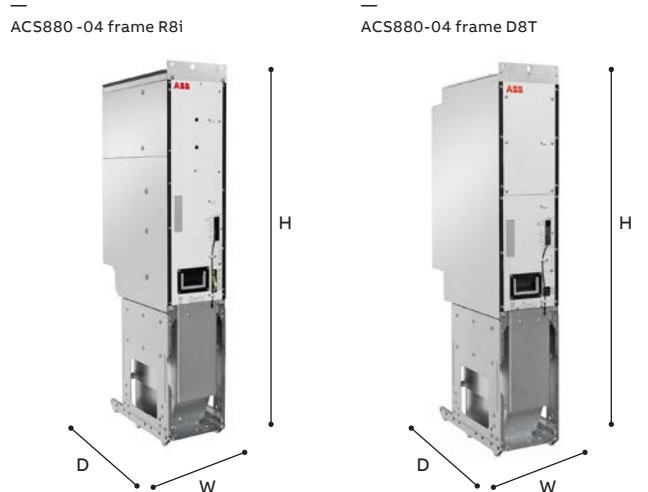
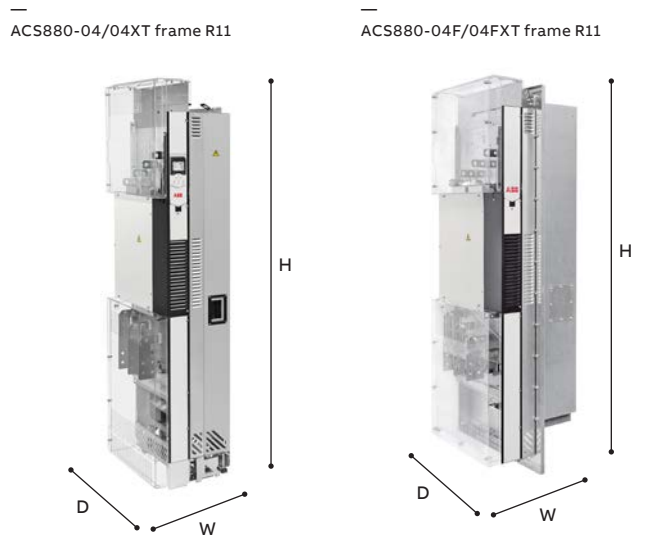
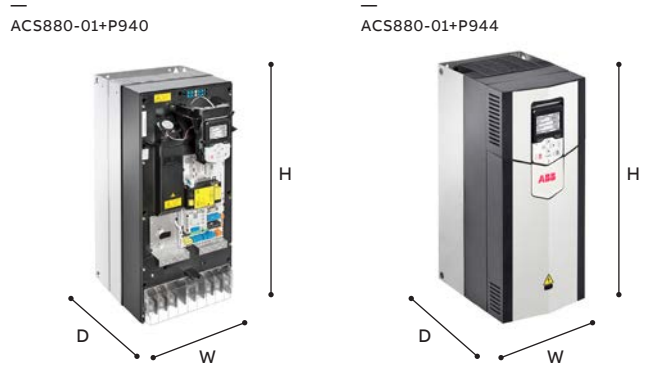

ACS880-11/31+P940, IP20

Frame size	Height (mm)	Width (mm)	Depth (mm)	Weight (kg)
R3	490	203	349	18.3
R6	771	252	358	59
R8	965	300	430	100/115 ¹⁾

¹⁾ 100 kg for 105A-3, 145A-3, 101A-5 and 124A-5.
115 kg for 169A-3, 206A-3, 156A-5 and 180A-5.

ACS880-14/34 frame R11, IP20

Frame size	Height (mm)	Width (mm)	Depth (mm)	Weight (kg)
R11	1741	713	512	365

ACS880-14/34 module packages, IP00

Frame size	Height (mm)	Width (mm)	Depth (mm)	Weight (kg)
Multidrive module				
R8i	1397	240	583	125
LCL line filter				
BLCL-13-5	1397	240	505	181
BLCL-15-5	1397	240	505	224
BLCL-24-5	1397	240	581	320
BLCL-25-5	1397	240	581	324
BLCL-13-7	1397	240	505	178
BLCL-15-7	1397	240	505	217
BLCL-24-7	1397	240	581	301
BLCL-25-7	1397	240	581	310

ACS880-104, air-cooled inverter unit (INU), IP20 (frames R1i to R5i), IP00 (frames R6i to R8i)

Frame size	Height (mm)	Width (mm)	Depth (mm)	Weight (kg)
R1i	364	90	234	3
R2i	380	100	312	5
R3i	467	168	313	10
R4i	467	223	313	17
R5i	596	203	240	14
R6i	890	170	456	38
R7i	890	170	456	39
R8i	1397	240	583	125

With module covers and without strain relief clamps (R1i to R4i).
With module covers (R5i).

ACS880-11/31+P940

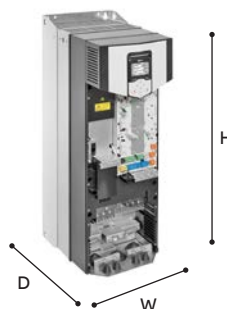

ACS880-14/34 R11

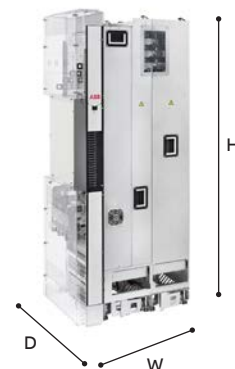

ACS880-14/34 frame R8i



BLCL filter



ACS880-104 frame R6i



ACS880-104 frame R8i



ACS880-204, air-cooled IGBT supply unit (ISU), IP20 (frames R1i to R4i), IP00 (frames R6i and R8i)

Frame size	Height (mm)	Width (mm)	Depth (mm)	Weight (kg)
Multidrive module				
R1i	364	90	234	4
R2i	380	100	312	6
R3i	467	165	313	11
R4i	467	220	313	18
R6i	900	170	456	38
R8i	1397	240	583	125

LCL line filter

WFU-01	315	213	218	11
WFU-02	315	213	218	11
WFU-11	386	288	256	34
WFU-21	406	318	299	45
WFU-22	406	318	299	51
ALCL-05-5	845	378	305	100
BLCL-13-5	1397	240	505	181
BLCL-15-5	1397	240	505	224
BLCL-24-5	1397	240	581	320
BLCL-25-5	1397	240	581	324
BLCL-13-7	1397	240	505	178
BLCL-15-7	1397	240	505	218
BLCL-24-7	1397	240	581	301
BLCL-25-7	1397	240	581	310

ACS880-204 frame R8i



BLCL filter



ACS880-304, air-cooled diode supply modules (DSU), IP00

Frame size	Height (mm)	Width (mm)	Depth (mm)	Weight (kg)
D6D	815	170	415	37
D7D	1054	170	417	73
D8D	1397	240	589	173
D7T	1178	170	417	80
D8T	1397	240	589	180

ACS880-304 frame D8T



ACS880-904, air-cooled regenerative rectifier unit (RRU), IP00

Frame size	Height (mm)	Width (mm)	Depth (mm)	Weight (kg)
Multidrive module				
R8i	1397	240	583	125
L filter				
BL-15-5	1397	240	444	155
BL-25-5	1397	240	549	215
BL-15-7	1397	240	444	155
BL-25-7	1397	240	549	215

ACS880-904 frame R8i



L filter

**ACS880-1604, DC/DC converter, IP00**

Frame size	Height (mm)	Width (mm)	Depth (mm)	Weight (kg)
Multidrive module				
R8i	1397	240	583	125
DCL filter				
BDCL-14-5	1397	240	444	195
BDCL-14-7	1397	240	444	195
BDCL-15-5	1397	240	444	225
BDCL-15-7	1397	240	444	225

ACS880-1604 frame R8i



BDCL

**ACS880-104LC, liquid-cooled inverter unit (INU), IP00**

Frame size	Height (mm)	Width (mm)	Depth (mm)	Weight (kg)
R8i	880	210	487	59/63 ¹⁾

¹⁾ For 0390A-7 to 0530A-7 the weight is 59 kg.
 For 0600A-7 to 0850A-7 the weight is 63 kg.
 For 1030A-7 the weight is 59 kg per module.
 For 1170A-7 to 3260A-7 the weight is 63 kg per module.

ACS880-104LC

**ACS880-304LC, liquid-cooled diode supply unit (DSU), IP00**

Frame size	Height (mm)	Width (mm)	Depth (mm)	Weight (kg)
D8D	242	170	292	12

ACS880-304LC

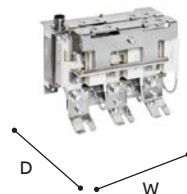

ACS880-204LC, liquid-cooled IGBT supply unit (ISU), IP00

Frame size	Height (mm)	Width (mm)	Depth (mm)	Weight (kg)
Multidrive module				
R8i	880	210	487	59/63 ¹⁾
LCL filter				
Grid-side choke				
BLCL-15LC-7	447	345	369	144
BLCL-24LC-7	447	345	369	146
BLCL-25LC-7	478	441	380	212
Converter-side choke				
BLCL-15LC-7	449	345	378	150
BLCL-24LC-7	449	345	378	148
BLCL-25LC-7	477	443	386	216

¹⁾ For 0360A-7 to 0480A-7 the weight is 59 kg.
 For 0560A-7 to 0770A-7 the weight is 63 kg.
 For 0930A-7 the weight is 59 kg per module.
 For 1090A-7 the weight is 63 kg per module.

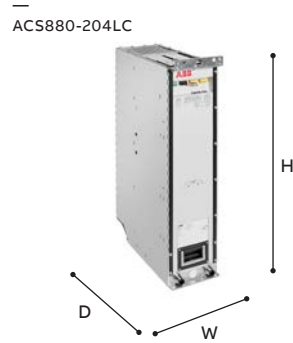

ACS880-1604LC, liquid-cooled DC/DC converter, IP00

Frame size	Height (mm)	Width (mm)	Depth (mm)	Weight (kg)
Multidrive module				
R8i	880	210	487	59/63 ¹⁾
DCL filter				
BDCL-14LC-7	1009	240	455	235
BDCL-15LC-7	1009	240	455	265

¹⁾ For 0400A-7 and 0500A-7 the weight is 59 kg.
 For 0600A-7 to 0850A-7 the weight is 63 kg.
 For 1000A-7 the weight is 59 kg per module.
 For 1200A-7 to 1800A-7 the weight is 63 kg per module.

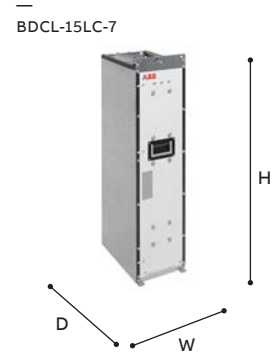
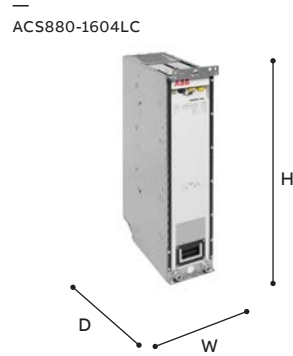

ACS880-1007LC, liquid cooling unit, IP54

Unit type	Height (mm)	Width (mm)	Depth (mm)	Weight (kg)
ACS880-1007LC-0070	2002	330	644	200
ACS880-1007LC-0195+C140	2002	630	644	310
ACS880-1007LC-0195+C141	2002	630	644	366
ACS880-1007LC-0195+C213	2002	630	644	373



Standard interface and extensions for plug-in connectivity

—
01 Control unit ZCU
—
02 Example of a typical drive modules input/output connection diagram. Variations maybe possible. For further information, please see the ACS880 user manual.

ACS880 drive modules offer a wide range of standard interfaces including extensive selection of I/O connections, Safe Torque Off (STO) and a galvanically isolated RS485 link that can be configured as either Modbus RTU or high speed drive-to-drive link.

In addition, the drive control unit (ZCU/BCU) has three option slots that can be used for extensions, including communication protocol adapters, input/output extension modules, feedback modules, and a safety functions module. For I/O extensions, see page 68.

External control unit BCU-X2 is used with all parallel connected modules, such as n×R8i, n×DxT, -04XT and 04FXT.



Control connections	Description
2 analog inputs (XAI)	Current input: -20 to 20 mA, R_{in} : 100 ohm Voltage input: -10 to 10 V, $R_{in} > 200$ kohm Resolution: 11 bit + sign bit
2 analog outputs (XAO)	0 to 20 mA, $R_{load} < 500$ ohm Frequency range: 0 to 300 Hz Resolution: 11 bit + sign bit
6 digital inputs (XDI)	Input type: NPN/PNP (DI1 to DI5), NPN (DI6) DI6 (XD1:6) can alternatively be used as an input for a PTC thermistor.
Digital input interlock (DIIL)	Input type: NPN/PNP
2 digital inputs/outputs (XDIO)	As input: 24 V logic levels: "0" < 5 V, "1" > 15 V R_{in} : 2.0 kohm Filtering: 0.25 ms As output: Total output current from 24 V DC is limited to 200 mA Can be set as pulse train input and output
3 relay outputs (XRO1, XRO2, XRO3)	250 V AC/30 V DC, 2 A
Safe torque off (XSTO)	For the drive to start, both connections must be closed
Drive-to-drive link (XD2D)	Physical layer: EIA-485
Built-in Modbus	EIA-485
Assistant control panel/PC tool connection	Connector: RJ-45

—
02

Relay outputs		XRO1, XRO2, XRO3		
Ready 250 V AC/30 V DC 2 A	NO	13		
	COM	12		
	NC	11		
Running 250 V AC/30 V DC 2 A	NO	23		
	COM	22		
	NC	21		
Faulted(-1) 250 V AC/30 V DC 2 A	NO	33		
	COM	32		
	NC	31		
External power input		XPOW		
24 V DC, 2 A	GND	2		
	+24VI	1		
Reference voltage and analog inputs		J1, J2, XAI		
AI1/AI2 current/voltage selection	AI1:U	AI2:U		
	AI1:I	AI2:I		
By default not in use. 0(4) to 20 mA, $R_{in} = 100 \text{ ohm}$	AI2-	7		
	AI2+	6		
Speed reference 0(2) to 10 V, $R_{in} > 200 \text{ kohm}$	AI1-	5		
	AI1+	4		
Ground	AGND	3		
-10 V DC, $R_L 1 \text{ to } 10 \text{ kohm}$	-VREF	2		
10 V DC, $R_L 1 \text{ to } 10 \text{ kohm}$	+VREF	1		
Analog outputs		XAO		
Motor current 0 to 20 mA, $R_L < 500 \text{ ohm}$	AGND	4		
	AO2	3		
Motor speed rpm 0 to 20 mA, $R_L < 500 \text{ ohm}$	AGND	2		
	AO1	1		
Drive-to-drive link		J3, XD2D		
Drive-to-drive link termination	ON	OFF		
	Shield	4		
Drive-to-drive link or built-in Modbus	BGND	3		
	A	2		
	B	1		
Safe torque off		XSTO		
Safe torque off. Both circuits must be closed for the drive to start.	IN2	4		
	IN1	3		
	SGND	2		
	OUT	1		
Digital inputs		XDI		
By default not in use	DI6	6		
Constant speed 1 select (1=on)	DI5	5		
Acceleration and deceleration select	DI4	4		
Reset	DI3	3		
Forward (0)/Reverse (1)	DI2	2		
Stop (0)/Start (1)	DI1	1		
Digital input/outputs		XDIO		
Output: Running	DIO2	2		
Output: Ready	DIO1	1		
Ground selection		XD24		
Digital input/output ground	DIOGND	5		
+24 V DC 200 mA	+24VD	4		
Digital input ground	DICOM	3		
+24 V DC 200 mA	+24VD	2		
Digital interlock	DIIL	1		
Safety functions module connection		X12		
Control panel/PC connection		X13		
Memory unit connection		X205		

Control panel options

— 01 Bluetooth assistant control panel, ACS-AP-W

— 02 Industrial assistant control panel without Bluetooth, ACS-AP-I

— 03 Control panel mounting platform DPMP-01

— 04 Control panel mounting platform DPMP-02

Standard *) Bluetooth assistant control panel, ACS-AP-W and Industrial assistant control panel, ACS-AP-I

Assistant control panel with clear multilingual graphical display can be used for parameter setting and back-up, drive monitoring and operation, fault tracing and as a USB link for a PC tool. There are two different assistant control panels – with (ACS-AP-W) or without (ACS-AP-I) Bluetooth. The panels can be mounted either on the drive or on the door of the enclosure and they are compatible with any ABB all-compatible drive.

Control panel helps you to set up the essential settings quickly and get the drive into action. Also diagnostics is easy due to event history, clear text messages and realtime stamps.

The Bluetooth connection enables the use of mobile apps like Drivetune. This app is available for free on the Google Play and the Apple App store. Drivetune features include: commissioning, troubleshooting, monitoring and controlling the drive remotely. Drivetune also has full parameter access and backup and restore functionality.

Control panel mounting platform, DPMP-01, is for flush mountings and has IP54/UL Type 12 protection class (IP20, when control panel is not mounted). Supports daisy chaining of the control panel link.

Control panel mounting platform, DPMP-02, is for surface mounting and has IP65 / UL Type 12 protection class (IP20, when control panel not mounted).



Control panel options

Option code	Ordering code for loose item	Description	Type
+0J400 ¹⁾	—	No control panel	—
—	3AXD50000025965	Bluetooth Assistant control panel. *) Included as standard for ACS880-01/11/31 and ACS880-04/04F up to frame size R11.	ACS-AP-W
+J425 ¹⁾	3AUA0000088311	Industrial assistant control panel without Bluetooth connection	ACS-AP-I
—	3AUA0000108878	Control panel mounting platform, flush mounted, IP54 / UL Type 12 (does not include control panel)	DPMP-01
—	3AXD50000009374	Control panel mounting platform, surface mounted, IP65 / UL Type 12 (does not include control panel)	DPMP-02

¹⁾ Plus codes are valid for ACS880-01/11/31/04/04F and -14/34 frame R11.

ABB Ability™ smartphone apps

Better connectivity and user experience with Drivetune

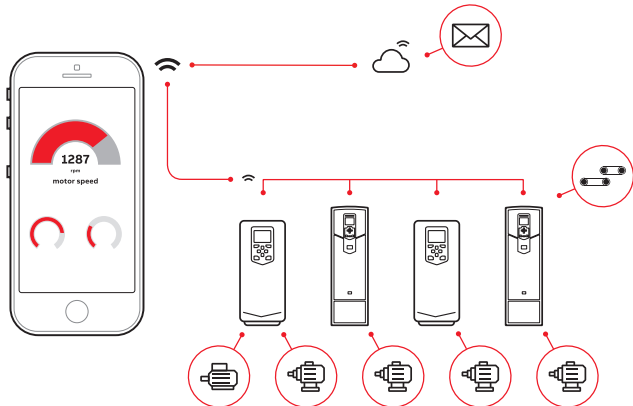

Easy and fast access to product information and support



Start-up, commission and tune your drive and application



Instantly access drive status and configuration with a simplified user guidance



Optimize performance via drive troubleshooting features



Create and share backups and support packages

Services and support on the go with Drivebase

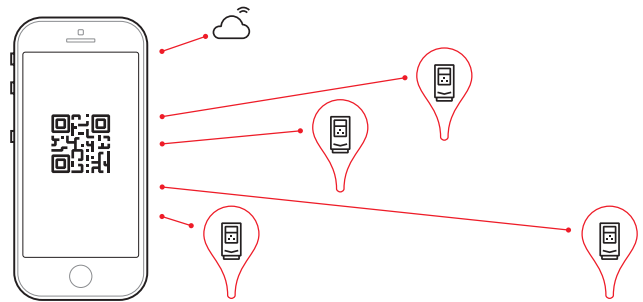

Search for support documents and contacts



Access your product and service information in the cloud from anywhere



View your drives installed base and plan service activities



Use dynamic QR code to troubleshoot your drive



Report service events

Access information anywhere

Download the apps using the QR codes below or directly from the app stores



Drivetune for commissioning and managing drives



Drivebase for ensured reliability and reduced downtime on production sites

Connectivity to automation systems

—
01 ACS880 is compatible with many communication protocols

—
02 Input/output extension modules

Communication protocol adapters

ACS880 industrial drives are compatible with a wide range of communication protocols. The drive comes with a Modbus RTU fieldbus interface as standard.

The ACS880 supports two different communication connections simultaneously and offers the possibility for redundant communication. PROFIsafe (functional safety over PROFINET) is also supported.

Communication protocol adapters

Option code ¹⁾	Ordering code for loose item	Communication protocol	Adapter
+K451	68469341	DeviceNet™	FDNA-01
+K454	68469325	PROFIBUS DP, DPV0/DPV1	FPBA-01
+K457	68469376	CANopen®	FCAN-01
+K458	3AUA0000031336	Modbus RTU	FSCA-01
+K462	3AUA0000094512	ControlNet	FCNA-01
+K469	3AUA0000072069	EtherCAT®	FECA-01
+K470	3AXD5000019239	POWERLINK	FEPL-02
+K475	3AUA0000089109	Two port EtherNet/IP™, Modbus TCP, PROFINET IO, PROFIsafe ²⁾	FENA-21
+K491	3AXD50000049964	Modbus/TCP	FMBT-21
+K492	3AXD50000192779	PROFINET IO	FPNO-21
+K490	3AXD50000192786	EtherNet/IP	FEIP-21
+Q986	3AXD50000112821	PROFIsafe safety functions module	FSPS-21

¹⁾ Plus codes are valid for ACS880-01/11/31/04/04F and -14/34 frame R11.

²⁾ For the PROFIsafe to work the PROFINET fieldbus adapter module (FENA-21) and the safety functions module FSO-12 (+Q973) or FSO-21 (+Q972) are required.



01



02

Input/output extension modules

Standard input and output can be extended by using optional analog and digital input/output extension modules. The modules are easily installed in the extension slots located on the drive.

If there are not enough I/O extension slots in the drive, the FEA-03 module can increase the number of slots. The FEA-03 has two option slots for digital I/O extensions and speed feedback interface modules. The connection to the control unit is via an optical fiber link, and the adapter can be mounted on a DIN rail (35 × 7.5 mm).

Analog and digital input/output extension modules

Option code ¹⁾	Ordering code for loose item	Description	I/O module
+L501	68805368	4×DI/O, 2×RO	FIO-01
+L500	68805384	3×AI (mA/V), 1×AO (mA), 2×DI/O	FIO-11
+L515	3AUA0000108669	2×F-type option extension slots	FEA-03
+L525	3AUA0000141436	2×AI(mA/V), 2×AO(mA)	FAIO-01
+L526	3AUA0000141438	3×DI (up to 250 V DC or 230 V AC), 2×RO	FDIO-01

¹⁾ Plus codes are valid for ACS880-01/11/31/04/04F and -14/34 frame R11.

Feedback interface and DDCS communication options

- 03 FEN-01 TTL encoder interface module
- 04 FDCO-01 DDCS communication module

Speed feedback interfaces for precise process control

ACS880 drives can be connected to various feedback devices, such as HTL pulse encoders, TTL pulse encoders, absolute encoders and resolvers. The optional feedback module is installed in the option slot on the drive. It is possible to use two feedback modules at the same time, either of the same type or different types *).

*) Excluding FSE-31.



— 03

Feedback interface modules

Option code ¹⁾	Ordering code for loose item	Description	Feedback module
+L517	68805422	2 inputs (TTL pulse encoder), 1 output	FEN-01
+L518	68805830	2 inputs (SinCos absolute, TTL pulse encoder), 1 output	FEN-11
+L516	68805848	2 inputs (Resolver, TTL pulse encoder), 1 output	FEN-21
+L502	68978955	1 input (HTL pulse encoder), 1 output	FEN-31
+L521	3AXD5000023272	Pulse encoder interface for functional safety (for more details see section "Safety options")	FSE-31

DDCS communication option modules

The FDCO-0X optical DDCS communication options are add-on modules on the ACS880 industrial drives control unit. The modules include connectors for two fiber optic DDCS channels. The FDCO-0X modules make it possible to perform master-follower and AC800 M communication. Alternative way for drive to drive communication is to use the standard RS485 connection.



— 04

Optical communication modules

Option code ¹⁾	Ordering code for loose item	Description	Module
+L503	3AUA0000107392	Optical DDCS (10 Mbd/10 Mbd)	FDCO-01
+L508	3AUA0000107393	Optical DDCS (5 Mbd/10 Mbd)	FDCO-02

¹⁾ Plus codes are valid for ACS880-01/11/31/04/04F and -14/34 frame R11.

Remote monitoring options

- 01 Remote monitoring tool NETA-21
- 02 RMDE reliability monitoring device

Remote monitoring access worldwide

The NETA-21 remote monitoring tool gives easy access to the drive via the Internet or a local Ethernet network. NETA-21 comes with a built-in web server. Compatible with standard web browsers, it ensures easy access to a web-based user interface. Through the web interface, the user can configure drive parameters, and monitor drive log data, load levels, runtime, energy consumption, I/O data, and the bearing temperatures of the motor connected to the drive. One NETA-21 supports up to 10 ABB single drives.



01

Remote monitoring option

Ordering code	Description	Type
3AUA0000094517	2 x panel bus interface max. 10 drives 2 x Ethernet interface SD memory card USB port for WLAN/3G	NETA-21



02

RMDE reliability monitoring device

The RMDE reliability monitoring device collects drive performance and event data so that it can be stored remotely and utilized for service, maintenance and troubleshooting. RMDE consists of the NETA-21 remote monitoring tool, a modem, and environmental sensors that enable collection of measured ambient temperature and humidity values. The device comes in a compact IP54 enclosure, making it suitable even for harsh environments.

RMDE reliability monitoring device

Ordering code	Description	Type
RMDE-01-1-1 Configurable product	RMDE reliability monitoring device	RMDE-01

PC tool options

- 03 Drive Composer PC tool
- 04 Automation Builder PC tool

PC tools

The **Drive Composer** PC tool offers fast and harmonized setup, commissioning and monitoring for ABB's all-compatible drives. The free version of the tool, **Drive Composer Entry**, provides startup and maintenance capabilities, and includes support for adaptive programming. It also gathers all drive information, such as parameter loggers, faults, backups and event lists, into a support diagnostics file.

Drive Composer Pro provides additional features, such as

- graphical reference and control chain diagrams
- possibility to connect to several drives simultaneously over Ethernet
- graphical interface for configuring functional safety features.

Automation Builder can be used as an alternative configuration tool to Drive Composer. It is a common tool for several ABB automation products, such as drives, PLCs, HMIs and robots.

For customized solutions, drive application programming based on IEC61131 standard is available for full PLC programmability with the **Drive Application Builder** tool.



— 03



— 04

PC tools

Ordering code	Description	PC tool
3AUA0000108087	PC tool for setup, commissioning and monitoring of drives	Drive Composer Pro
3AXD50000342389	Standard version of the Drive Application Builder for IEC 61131-3 programming, DABS-STANDARD	licenses for Drive Application Builder ¹⁾
3AXD50000342402	Premium version of the Drive Application Builder for IEC 61131-3 programming, DABP-PREMIUM	
3AXD50000343027	Software development productivity add-ons for Drive Application Builder, version control and static analysis extensions for improve software engineering productivity, single workstation, DABX-PRODUCTIVITY-ADD-ONS	
1SAS010000R0102	Automation Builder 2.x Standard (2). Integrated engineering for PLC, drives, motion, SCADA and panels.	Automation Builder
1SAS010002R0102	Automation Builder 2.x Premium (5). Integrated Engineering and features for engineering productivity and collaboration.	Automation Builder
+N8010	License key for drive application programming based on IEC 61131-3 using Drive Application Builder	IEC programming

¹⁾ For IEC programming license key is needed for the ACS880 drive (+N8010)

Safety options

—
01 ACS880 drive
with FSO-21, FSE-31
and FENA-21

Integrated safety

Integrated safety reduces the need for external safety components, simplifying configuration and reducing installation space. The safety functionality is a built-in feature of the ACS880, with safe torque off (STO) as standard. The STO function corresponds to an uncontrolled stop in accordance with stop category 0 of EN 60204-1. Additional safety functions can be commissioned with the optional and compact safety functions module. ACS880 drives offer functional safety with or without encoder. The drive's functional safety is designed in accordance with EN/IEC 61800-5-2 and complies with the requirements of the European Union Machinery Directive (2006/42/EC).

The safety functions are certified by TÜV Nord and comply with the highest performance requirements (SIL 3/PL e) in machinery safety.¹⁾

The safety functions module can also be ordered separately and installed afterwards to the drive.

PROFIsafe safety functions module, FSPS-21, with integrated PROFIsafe, and PROFINET IO connection supports STO and SS1-t safety functions. Since the functions are automatically configured, no additional safety settings are required in the drive.

Safety functions modules, FSO-12 and FSO-21, support a wide range of safety functions. Configuration of the functions is done with the Drive Composer Pro PC tool, which provides an easy-to-use graphical user interface. Larger safety systems can be built using PROFIsafe over PROFINET connection between a safety PLC (such as AC500-S) and the ACS880 drive.

Safety function modules

Option code ²⁾	Ordering code for loose item	Description	Safety module
+Q973	3AXD50000016771	Safety functions module FSO-12	FSO-12
+Q972+L521	3AXD50000023987 + 3AXD50000023272	Safety functions module FSO-21 and encoder FSE-31	FSO-21+FSE-31
+Q971	—	ATEX-certified safe disconnection function, EX II (2) GD	
+Q982	—	PROFIsafe safety communication to be used together with FSO-12 or FSO-21: forces to select a functional safety module and PROFINET adapter, FPNO-21	FSO-12 or FSO-21 +FPNO-21
+Q986 ³⁾	3AXD50000112821	PROFIsafe safety functions module FSPS-21	FSPS-21
+L536	3AXD50000024934	Thermistor protection module FPTC-01	FPTC-01
+L537+Q971	3AXD50000024924	ATEX-certified thermistor protection module FPTC-02, Ex II (2) GD	FPTC-02

¹⁾ Thermistor modules comply with SIL 2 / PL c.

²⁾ Plus codes are valid for ACS880-01/11/31/04/04F and -14/34 frame R11.

³⁾ Please contact your local ABB office to check availability.



—
01

The connection is achieved by adding a PROFINET adapter, FPNO-21, to the drive.

Supported safety functions:

- Encoderless: SS1-t, SS1-r, SLS, SBC, SMS, SSE, POUS, STO
- With encoder (requires FSO-21 + FSE-31): SDI, SSM, SS1-t, SS1-r, SLS, SBC, SMS, SSE, POUS, STO

Pulse encoder interface module, FSE-31, provides safe encoder data to the safety functions module, and can simultaneously be used as a feedback device for the drive. FSE-31 requires an FSO-21 safety functions module and supports HTL encoders.

Thermistor protection modules, FPTC-01 and FPTC-02

Safe temperature monitoring (STM) can be achieved by using FPTC thermistor protection modules.¹⁾

Safety function	Description	Supported functions			
		FSPS-21 (SS1-t)	FSO-12 without encoder (SS1-t) (SS1-r)	FSO-21 + FSE-31 + HTL encoder (SS1-t) (SS1-r)	
Safe stop 1 SS1-t SS1-r	Brings the machine to a stop using a monitored deceleration ramp. It is typically used in applications where the machinery motion needs to be brought to a stop (stop category 1) in a controlled way before switching over to the no-torque (STO) state	x	x	x	
Safe stop emergency SSE	Can be configured to, upon request, either activate STO instantly (category 0 stop), or first initiate motor deceleration and then, once the motor has stopped, activate the STO (category 1 stop).		x	x	
Safe brake control SBC	Provides a safe output for controlling the motor's external (mechanical) brakes, together with STO.		x	x	
Safely-limited speed SLS	Ensures that the specified speed limit of the motor is not exceeded. This allows machine interaction to be performed at slow speed without stopping the drive. The safety function module comes with four individual SLS settings for speed monitoring.		x	x	
Safe maximum speed SMS	Monitors that the speed of the motor does not exceed the configured maximum speed limit.		x	x	
Prevention of unexpected start-up POUS	Ensures that the machine remains stopped when people are in the danger area.		x	x	
Safe direction SDI	Ensures that rotation is allowed only in the selected direction (available only with FSO-21 and FSE-31).			x	
Safe speed monitor SSM	Provides a safe output signal to indicate whether the motor speed is between user-defined limits (available only with FSO-21).			x	
Safe torque off STO	Brings the drive safely to a no-torque state, i.e. switches off the drive output to the motor, motor speed then coasts to a stop. ACS880 has safe torque off as standard.	x	x	x	

EMC – electromagnetic compatibility

—
01 Immunity and
emission compatibility

Each ACS880 model can be equipped with a built-in filter to reduce high-frequency emissions.

EMC standards

The EMC product standard (EN 61800-3) covers the specific EMC requirements for drives (tested with motor and motor cable) within the EU. EMC standards such as EN 55011 or EN 61000-6-3/4 are applicable to industrial and domestic equipment and systems, including the components inside the drive. Drive units compliant with EN 61800-3 are also compliant with comparable categories in EN 55011 and EN 61000-6-3/4, but not necessarily vice versa. EN 55011 and EN 61000-6-3/4 do not specify cable length or require a motor to be connected as a load. The emission limits are comparable

to EMC standards according to the table on the next page.

Domestic environments versus public low voltage networks

The first environment includes domestic premises. It also includes establishments directly connected without an intermediate transformer to a low voltage power supply network that supplies buildings used for domestic purposes.

The second environment includes all establishments other than those directly connected to a low voltage power supply network that supplies buildings used for domestic purposes.

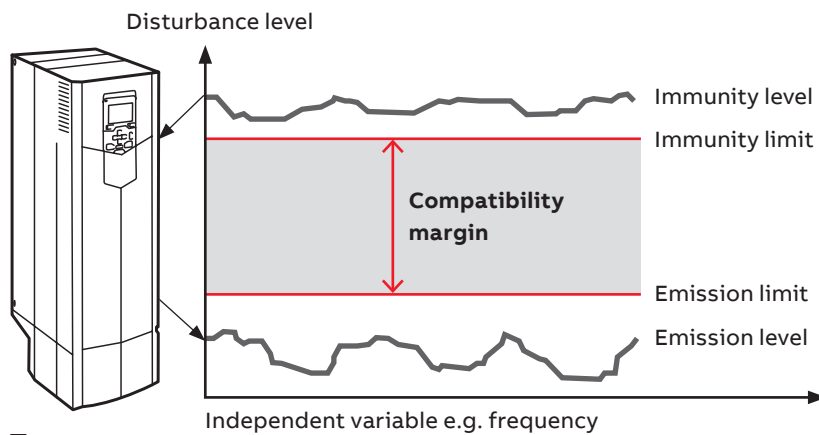

—
01

EMC standards				
EMC according to EN 61800-3:2004 + A1:2012 product standard	EN 61800-3 product standard	EN 55011, product family standard for industrial, scientific and medical (ISM) equipment	EN 61000-6-4, generic emission standard for industrial environments	EN 61000-6-3, generic emission standard for residential, commercial and light-industrial environment
1 st environment, restricted distribution	Category C2	Group 1. Class A	Applicable	Not applicable
2 nd environment, unrestricted distribution	Category C3	Group 2. Class A	Not applicable	Not applicable
2 nd environment, restricted distribution	Category C4	Not applicable	Not applicable	Not applicable

Selecting an EMC filter

Drive type	Voltage (V)	Frame sizes	1 st environment, restricted distribution, C2, grounded network (TN) Option code	2 nd environment, C3, grounded network (TN) Option code	2 nd environment, C3, ungrounded network (IT) Option code	2 nd environment, C4, grounded network (TN) ⁴⁾
ACS880-01	380 to 500	R1 to R9	+E202	+E200	+E201 ¹⁾	As standard
ACS880-01	690	R3 to R9	-	+E200	+E201 ¹⁾	As standard
ACS880-04	380 to 500	R10, R11	+E202	+E200	+E201	As standard
ACS880-04	690	R10, R11	-	+E200	+E201	As standard
ACS880-04	380 to 690	nxD8T+ n×R8i	Not for 690 V. Only for 1×D8T ²⁾	As standard ³⁾	As standard ³⁾	As standard
ACS880-04F	380 to 690	R11	-	+E200	+E201	As standard
ACS880-04XT	380 to 500	2×R10/11	ARFI-10	+E200	+E201	As standard
ACS880-04XT	690	2×R10/11	-	+E200	+E201	As standard
ACS880-04FXT	380 to 500	n×R11	ARFI-10	+E200	+E201	As standard
ACS880-04FXT	690	n×R11	-	+E200	+E201	As standard
ACS880-11	380 to 500	R3 to R8	+E202 (not available for R8)	+E200	+E201	As standard
ACS880-31	380 to 500	R3 to R8	+E202 (not available for R8)	+E200	+E201	As standard
ACS880-14	380 to 690	R11	+E202	+E200	-	As standard
ACS880-14	380 to 690	n×R8i	Not for 690 V. Only for 1×R8i ²⁾	As standard ³⁾	As standard ³⁾	As standard
ACS880-34	380 to 690	R11	+E202	+E200	-	As standard
ACS880-34	380 to 690	n×R8i	Not for 690 V. Only for 1×R8i ²⁾	As standard ³⁾	As standard ³⁾	As standard
ACS880-104	380 to 690	R1 to n×R8i	-	As standard ³⁾	As standard ³⁾	As standard
ACS880-204	380 to 690	R1i to R4i, R6i, n×R8i	Not for 690 V. Only for sizes up to 1×R8i ²⁾	As standard ³⁾	As standard ³⁾	As standard
ACS880-304	380 to 690	D×D, n×DXT	Not for 690 V. Only for 1×D8T ²⁾	As standard ³⁾	As standard ³⁾	As standard
ACS880-104LC	690	n×R8i	-	As standard ³⁾	As standard ³⁾	As standard
ACS880-204LC	690	n×R8i	-	As standard ³⁾	As standard ³⁾	As standard
ACS880-304LC	690	n×D8D	-	As standard ³⁾	As standard ³⁾	As standard

¹⁾ 2nd environment, C4: ACS880-01, 380 to 500 V, frame sizes R1 to R5. ACS880-01, 690 V, frame sizes R3 to R6.

²⁾ For Category C2 optional equipment is needed, and the drive must be installed according to the instructions given in the manuals.

³⁾ For Category C3 no optional equipment is needed, but the drive must be installed according to the instructions given in the manuals.

⁴⁾ For Category C4 no optional equipment is needed, but the drive must be installed according to the instructions given in the manuals.

Sine filters

Together with a sine filter, ACS880 drives offer smooth motor operation in both DTC and scalar modes. The sine filter suppresses the high-frequency components of the motors output voltage, creating almost a sinusoidal voltage wave form for the motor. The filter offers an optimized LC design that takes into account the switching frequency, voltage drop and filtering characteristics.

The ACS880 inverter and sine filter solution can be used together with a variety of requirements for products and components:

- For motors without adequate insulation for the role
- Where the total motor cable length is long as a result of a number of parallel motors
- For step-up applications, e.g. where a medium voltage motor needs to be driven
- For submersible pumps with long motor cables, e.g. in the oil industry
- When the motor noise needs to be reduced
- When there are industry-specific requirements for peak voltage level and voltage rise time

Sine filter for wall-mounted single drives, ACS880-01

$U_N = 400\text{ V}$ (range 380 to 415 V). The power ratings are valid at nominal voltage 400 V.

I_N (A)	P_N ¹⁾ (kW)	Noise level ²⁾ (dB)	Heat dissipation ²⁾ (W)	Drive type	Frame size	Filter type	Degree of protection	Filter width		Filter depth		Filter height		Filter weight	
								IP00 (mm)	IP21 (mm)	IP00 (mm)	IP21 (mm)	IP00 (mm)	IP21 (mm)	IP00 (kg)	IP21 (kg)
2.3	0.75	72	60	ACS880-01-02A4-3	R1	B84143V0004R229	IP00/IP21	235	384	95	152	200	246	5	14.4
3.1	1.1	72	60	ACS880-01-03A3-3	R1	B84143V0004R229	IP00/IP21	235	384	95	152	200	246	5	14.4
3.8	1.5	72	60	ACS880-01-04A0-3	R1	B84143V0004R229	IP00/IP21	235	384	95	152	200	246	5	14.4
5.3	2.2	72	100	ACS880-01-05A6-3	R1	B84143V0006R229	IP00/IP21	235	384	95	152	200	246	5	14.4
7.2	3	72	90	ACS880-01-07A2-3	R1	B84143V0011R229	IP00/IP21	235	384	110	152	200	246	7	14.4
9.2	4	72	90	ACS880-01-09A4-3	R1	B84143V0011R229	IP00/IP21	235	384	110	152	200	246	7	14.4
12.1	5.5	72	80	ACS880-01-12A6-3	R1	B84143V0016R229	IP00/IP21	275	420	122	200	235	290	12	24.4
16	7.5	75	140	ACS880-01-017A-3	R2	B84143V0025R229	IP00/IP21	355	500	120	200	285	360	20	36
24	11	75	140	ACS880-01-025A-3	R2	B84143V0025R229	IP00/IP21	355	500	120	200	285	360	20	36
31	15	75	160	ACS880-01-032A-3	R3	B84143V0033R229	IP00/IP21	355	500	120	200	285	360	24	36
37	18.5	78	220	ACS880-01-038A-3	R3	B84143V0050R229	IP00/IP21	400	650	140	350	360	460	41	90.3
43	22	78	220	ACS880-01-045A-3	R4	B84143V0050R229	IP00/IP21	400	650	140	350	360	460	41	90.3
58	30	78	250	ACS880-01-061A-3	R4	B84143V0066R229	IP00/IP21	400	650	147	350	360	460	43	90.3
64	30	79	310	ACS880-01-072A-3	R5	B84143V0075R229	IP00/IP21	400	650	173	350	360	460	62	90.3
77	37	79	400	ACS880-01-087A-3	R5	B84143V0095R229	IP00/IP21	440	700	164	350	500	580	70	132
91	45	80	600	ACS880-01-105A-3	R6	B84143V0130R230	IP00/IP21	560	850	300	480	420	500	110	192
126	55	80	550	ACS880-01-145A-3	R6	B84143V0162S229	IP00/IP21	500	730	300	400	380	430	112	129.9
153	75	80	550	ACS880-01-169A-3	R7	B84143V0162S229	IP00/IP21	500	730	300	400	380	430	112	129.9
187	90	80	900	ACS880-01-206A-3	R7	B84143V0230S229	IP00/IP21	570	850	285	480	430	500	120	192
209	110	80	900	ACS880-01-246A-3	R8	B84143V0230S229	IP00/IP21	570	850	285	480	430	500	120	192
249	132	80	1570	ACS880-01-293A-3	R8	B84143V0390S229	IP00/IP21	555	850	328	550	580	610	212	268.4
297	160	80	1570	ACS880-01-363A-3	R9	B84143V0390S229	IP00/IP21	555	850	328	550	580	610	212	268.4
352	160	80	1570	ACS880-01-430A-3	R9	B84143V0390S229	IP00/IP21	555	850	328	550	580	610	212	268.4

Nominal ratings

I_N	Rated current of the drive-filter combination available continuously without overload at 40 °C.
P_N	Typical motor power

¹⁾ Please note that sine filters cause a voltage drop, reducing the available shaft power from the motor.

²⁾ Noise level is a combined value for the drive and the filter. Heat dissipation is a value for the filter.

For further information, please contact your local ABB office.

$U_N = 500\text{ V}$ (range 380 to 500 V). The power ratings are valid at nominal voltage 500 V.

I_N (A)	$P_N^{1)}$ (kW)	Noise level ⁽²⁾ (dB)	Heat dissipation ⁽²⁾ (W)	Drive type	Frame size	Filter type	Degree of protection	Filter width		Filter depth		Filter height		Filter weight	
								IP00 (mm)	IP21 (mm)	IP00 (mm)	IP21 (mm)	IP00 (mm)	IP21 (mm)	IP00 (kg)	IP21 (kg)
1.9	0.8	72	60	ACS880-01-02A1-5	R1	B84143V0004R229	IP00/IP21	235	384	95	152	200	246	5	14.4
2.8	1.1	72	60	ACS880-01-03A0-5	R1	B84143V0004R229	IP00/IP21	235	384	95	152	200	246	5	14.4
3.1	1.5	72	60	ACS880-01-03A4-5	R1	B84143V0004R229	IP00/IP21	235	384	95	152	200	246	5	14.4
4.4	2.2	72	100	ACS880-01-04A8-5	R1	B84143V0006R229	IP00/IP21	235	384	95	152	200	246	5	14.4
4.8	3	72	100	ACS880-01-05A2-5	R1	B84143V0006R229	IP00/IP21	235	384	95	152	200	246	5	14.4
7	4	72	90	ACS880-01-07A6-5	R1	B84143V0011R229	IP00/IP21	235	384	110	152	200	246	7	14.4
10.2	5.5	72	90	ACS880-01-11A0-5	R1	B84143V0011R229	IP00/IP21	235	384	110	152	200	246	7	14.4
13	7.5	70	80	ACS880-01-014A-5	R2	B84143V0016R229	IP00/IP21	275	420	122	200	235	290	12	24.4
20	11	75	140	ACS880-01-021A-5	R2	B84143V0025R229	IP00/IP21	355	500	120	200	285	360	20	36
25	15	75	160	ACS880-01-027A-5	R3	B84143V0033R229	IP00/IP21	355	500	120	200	285	360	24	36
32	18.5	78	220	ACS880-01-034A-5	R3	B84143V0050R229	IP00/IP21	400	650	140	350	360	460	41	90.3
35	22	78	220	ACS880-01-040A-5	R4	B84143V0050R229	IP00/IP21	400	650	140	350	360	460	41	90.3
44	30	78	250	ACS880-01-052A-5	R4	B84143V0066R229	IP00/IP21	400	650	147	350	360	460	43	90.3
52	37	78	250	ACS880-01-065A-5	R5	B84143V0066R229	IP00/IP21	400	650	147	350	360	460	43	90.3
61	37	78	310	ACS880-01-077A-5	R5	B84143V0075R229	IP00/IP21	400	650	173	350	360	460	62	132
80	55	80	630	ACS880-01-096A-5	R6	B84143V0130S230	IP00/IP21	565	850	300	480	420	500	110	192
104	55	80	630	ACS880-01-124A-5	R6	B84143V0130S230	IP00/IP21	565	850	300	480	420	500	110	192
140	90	80	550	ACS880-01-156A-5	R7	B84143V0162S229	IP00/IP21	500	730	300	400	380	430	112	129.9
161	110	80	550	ACS880-01-180A-5	R7	B84143V0162S229	IP00/IP21	500	730	300	400	380	430	112	129.9
205	132	80	900	ACS880-01-240A-5	R8	B84143V0230S229	IP00/IP21	570	850	285	480	430	500	120	192
221	132	80	900	ACS880-01-260A-5	R8	B84143V0230S229	IP00/IP21	570	850	285	480	430	500	120	192
289	200	80	1570	ACS880-01-361A-5	R9	B84143V0390S229	IP00/IP21	555	850	328	550	580	610	212	268.4
332	200	80	1570	ACS880-01-414A-5	R9	B84143V0390S229	IP00/IP21	555	850	328	550	580	610	212	268.4

$U_N = 690\text{ V}$ (range 525 to 690 V). The power ratings are valid at nominal voltage 690 V.

I_N (A)	$P_N^{1)}$ (kW)	Noise level ⁽²⁾ (dB)	Heat dissipation ⁽²⁾ (W)	Drive type	Frame size	Filter type	Degree of protection	Filter width		Filter depth		Filter height		Filter weight	
								IP00 (mm)	IP21 (mm)	IP00 (mm)	IP21 (mm)	IP00 (mm)	IP21 (mm)	IP00 (kg)	IP21 (kg)
7.3	5.5	72	90	ACS880-01-07A4-7	R3	B84143V0010R230	IP00/IP21	380	500	110	200	290	360	15	36
9.3	7.5	72	90	ACS880-01-09A9-7	R3	B84143V0010R230	IP00/IP21	380	500	110	200	290	360	15	36
13.5	11	72	130	ACS880-01-14A3-7	R3	B84143V0018R230	IP00/IP21	380	500	121	200	290	360	19	36
17.1	15	72	130	ACS880-01-019A-7	R3	B84143V0018R230	IP00/IP21	380	500	121	200	290	360	19	36
21	18.5	72	160	ACS880-01-023A-7	R3	B84143V0026R230	IP00/IP21	380	500	141	200	290	360	30	68
25	22	72	160	ACS880-01-027A-7	R3	B84143V0026R230	IP00/IP21	380	500	141	200	290	360	30	68
7.3	5.5	72	90	ACS880-01-07A3-7	R5	B84143V0010R230	IP00/IP21	380	500	110	200	290	360	15	36
9.3	7.5	72	90	ACS880-01-09A8-7	R5	B84143V0010R230	IP00/IP21	380	500	110	200	290	360	15	36
13.5	11	72	130	ACS880-01-14A2-7	R5	B84143V0018R230	IP00/IP21	380	500	121	200	290	360	19	36
17.1	15	72	130	ACS880-01-018A-7	R5	B84143V0018R230	IP00/IP21	380	500	121	200	290	360	19	36
21	18.5	72	160	ACS880-01-022A-7	R5	B84143V0026R230	IP00/IP21	380	500	141	200	290	360	30	68
25	22	72	160	ACS880-01-026A-7	R5	B84143V0026R230	IP00/IP21	380	500	141	200	290	360	30	68
33	30	75	250	ACS880-01-035A-7	R5	B84143V0040R230	IP00/IP21	440	650	147	350	355	430	49	90.3
40	37	75	250	ACS880-01-042A-7	R5	B84143V0040R230	IP00/IP21	440	650	147	350	355	430	49	90.3
48	45	78	290	ACS880-01-049A-7	R5	B84143V0056R230	IP00/IP21	440	650	162	350	355	430	52	90.3
56	55	78	290	ACS880-01-061A-7	R6	B84143V0056R230	IP00/IP21	440	600	162	350	355	430	52	90.3
78	75	79	610	ACS880-01-084A-7	R6	B84143V0092R230	IP00/IP21	500	700	193	350	490	580	85	132
92	90	79	610	ACS880-01-098A-7	R7	B84143V0092R230	IP00/IP21	500	700	193	350	490	580	85	132
112	110	80	630	ACS880-01-119A-7	R7	B84143V0130S230	IP00/IP21	565	850	300	480	420	500	110	192
112	110	80	630	ACS880-01-142A-7	R8	B84143V0130S230	IP00/IP21	560	850	230	480	569	500	110	192
138	132	80	930	ACS880-01-174A-7	R8	B84143V0207S230	IP00/IP21	560	850	279	550	570	610	185	268.4
161	132	80	930	ACS880-01-210A-7	R9	B84143V0207S230	IP00/IP21	560	850	279	550	570	610	185	268.4
208	200	80	930	ACS880-01-271A-7	R9	B84143V0207S230	IP00/IP21	560	850	279	550	570	610	185	268.4

Sine filters for wall-mounted regenerative and ultra-low harmonic drives, ACS880-11 and ACS880-31

$U_N = 400\text{ V}$ (range 380 to 415 V). The power ratings are valid at nominal voltage 400 V.

I_N (A)	$P_N^{1)}$ (kW)	Noise level ²⁾ (dB)	Heat dissipation ²⁾ (W)	Drive type	Frame size	Filter type	Degree of protection	Filter width		Filter depth		Filter height		Filter weight	
								IP00 (mm)	IP21 (mm)	IP00 (mm)	IP21 (mm)	IP00 (mm)	IP21 (mm)	IP00 (kg)	IP21 (kg)
9.2	4	72	90	ACS880-11/31-09A4-3	R3	B84143V0011R229	IP00/IP21	235	384	110	152	200	246	5.2	14.4
12.1	5.5	72	80	ACS880-11/31-12A6-3	R3	B84143V0016R229	IP00/IP21	275	420	122	200	235	290	7.9	24.4
16	7.5	75	140	ACS880-11/31-017A-3	R3	B84143V0025R229	IP00/IP21	355	500	120	200	285	360	12.1	36
24	11	75	140	ACS880-11/31-025A-3	R3	B84143V0025R229	IP00/IP21	355	500	120	200	285	360	12.1	36
31	15	75	160	ACS880-11/31-032A-3	R6	B84143V0033R229	IP00/IP21	355	500	120	200	285	360	12.1	36
37	18.5	78	220	ACS880-11/31-038A-3	R6	B84143V0050R229	IP00/IP21	400	650	140	350	360	460	20.2	104.7
43	22	78	220	ACS880-11/31-045A-3	R6	B84143V0050R229	IP00/IP21	400	650	140	350	360	460	20.2	104.7
58	30	78	250	ACS880-11/31-061A-3	R6	B84143V0066R229	IP00/IP21	400	650	147	350	360	460	21.2	104.7
64	37	79	310	ACS880-11/31-072A-3	R6	B84143V0075R229	IP00/IP21	400	650	173	350	360	460	24.9	104.7
77	45	79	400	ACS880-11/31-087A-3	R6	B84143V0095R229	IP00/IP21	440	700	164	350	500	580	36.1	142.1
91	55	80	600	ACS880-11/31-105A-3	R8	B84143V0130R230	IP00/IP21	565	850	300	480	420	500	71.2	204
126	75	80	550	ACS880-11/31-145A-3	R8	B84143V0162S229	IP00/IP21	500	730	300	400	380	430	57	125.6
153	90	80	550	ACS880-11/31-169A-3	R8	B84143V0162S229	IP00/IP21	500	730	300	400	380	430	57	125.6
187	110	80	900	ACS880-11/31-206A-3	R8	B84143V0230S229	IP00/IP21	570	850	285	480	430	500	69.9	204

$U_N = 500\text{ V}$ (range 380 to 500 V). The power ratings are valid at nominal voltage 500 V.

I_N (A)	$P_N^{1)}$ (kW)	Noise level ²⁾ (dB)	Heat dissipation ²⁾ (W)	Drive type	Frame size	Filter type	Degree of protection	Filter width		Filter depth		Filter height		Filter weight	
								IP00 (mm)	IP21 (mm)	IP00 (mm)	IP21 (mm)	IP00 (mm)	IP21 (mm)	IP00 (kg)	IP21 (kg)
7	4	72	90	ACS880-11/31-07A6-5	R3	B84143V0011R229	IP00/IP21	235	384	110	152	200	246	5.2	14.4
10.2	5.5	72	90	ACS880-11/31-11A0-5	R3	B84143V0011R229	IP00/IP21	235	384	110	152	200	246	5.2	14.4
13	7.5	70	80	ACS880-11/31-014A-5	R3	B84143V0016R229	IP00/IP21	275	420	122	200	235	290	7.9	24.4
20	11	75	140	ACS880-11/31-021A-5	R3	B84143V0025R229	IP00/IP21	355	500	120	200	285	360	12.1	36
25	15	75	160	ACS880-11/31-027A-5	R6	B84143V0033R229	IP00/IP21	355	500	120	200	285	360	12.1	36
32	18.5	78	220	ACS880-11/31-034A-5	R6	B84143V0050R229	IP00/IP21	400	650	140	350	360	460	20.2	104.7
35	22	78	220	ACS880-11/31-040A-5	R6	B84143V0050R229	IP00/IP21	400	650	140	350	360	460	20.2	104.7
44	30	78	250	ACS880-11/31-052A-5	R6	B84143V0066R229	IP00/IP21	400	650	147	350	360	460	21.2	104.7
52	37	78	250	ACS880-11/31-065A-5	R6	B84143V0066R229	IP00/IP21	400	650	147	350	360	460	21.2	104.7
61	37	78	310	ACS880-11/31-077A-5	R6	B84143V0075R229	IP00/IP21	400	650	173	350	360	460	24.9	104.7
80	55	80	630	ACS880-11/31-096A-5	R8	B84143V0130S230	IP00/IP21	565	850	300	480	420	500	71.2	204
104	55	80	630	ACS880-11/31-124A-5	R8	B84143V0130S230	IP00/IP21	565	850	300	480	420	500	71.2	204
140	90	80	550	ACS880-11/31-156A-5	R8	B84143V0162S229	IP00/IP21	500	730	300	400	380	430	57	125.6
161	110	80	550	ACS880-11/31-180A-5	R8	B84143V0162S229	IP00/IP21	500	730	300	400	380	430	57	125.6

Nominal ratings

I_N	Rated current of the drive-filter combination available continuously without overload at 40 °C.
P_N	Typical motor power

¹⁾ Please note that sine filters cause a voltage drop, reducing the available shaft power from the motor.

²⁾ Noise level is a combined value for the drive and the filter. Heat dissipation is a value for the filter.

For further information please contact your local ABB office.

Sine filters for single drive modules, ACS880-04

$U_N = 400\text{ V}$ (range 380 to 415 V). The power ratings are valid at nominal voltage 400 V.

I_N (A)	$P_N^{1)}$ (kW)	Heat dissipation ²⁾ (W)	Drive type	Frame size	Filter type
470	250	7000	ACS880-04-505A-3	R10	NSIN0900-6
540	250	9000	ACS880-04-585A-3	R10	NSIN0900-6
600	315	11000	ACS880-04-650A-3	R10	NSIN0900-6
647	355	12000	ACS880-04-725A-3	R11	NSIN0900-6
731	400	14000	ACS880-04-820A-3	R11	NSIN0900-6
785	450	15000	ACS880-04-880A-3	R11	NSIN0900-6

$U_N = 500\text{ V}$ (range 380 to 500 V). The power ratings are valid at nominal voltage 500 V.

I_N (A)	$P_N^{1)}$ (kW)	Heat dissipation ²⁾ (W)	Drive type	Frame size	Filter type
430	250	7000	ACS880-04-460A-5	R10	NSIN0485-6
470	315	9000	ACS880-04-503A-5	R10	NSIN0900-6
514	355	10000	ACS880-04-583A-5	R10	NSIN0900-6
560	400	11000	ACS880-04-635A-5	R10	NSIN0900-6
637	450	13000	ACS880-04-715A-5	R11	NSIN0900-6
730	500	15000	ACS880-04-820A-5	R11	NSIN0900-6
730	500	15000	ACS880-04-880A-5	R11	NSIN0900-6

$U_N = 690\text{ V}$ (range 525 to 690 V). The power ratings are valid at nominal voltage 690 V.

I_N (A)	$P_N^{1)}$ (kW)	Heat dissipation ²⁾ (W)	Drive type	Frame size	Filter type
330	315	7000	ACS880-04-330A-7	R10	NSIN0485-6
340	315	9000	ACS880-04-370A-7	R10	NSIN0485-6
360	355	10000	ACS880-04-430A-7	R10	NSIN0485-6
³⁾	³⁾	10000	ACS880-04-425A-7	R11	NSIN0485-6
³⁾	³⁾	12000	ACS880-04-470A-7	R11	NSIN0900-6
³⁾	³⁾	13000	ACS880-04-522A-7	R11	NSIN0900-6
530	500	14000	ACS880-04-590A-7	R11	NSIN0900-6
550	560	15000	ACS880-04-650A-7	R11	NSIN0900-6
550	630	15000	ACS880-04-721A-7	R11	NSIN0900-6

Nominal ratings

I_N	Rated current of the drive-filter combination available continuously without overload at 40 °C.
P_N	Typical motor power

¹⁾ Please note that sine filters cause voltage drop thus reducing the available shaft power from the motor.

²⁾ Noise level is a combined value for the drive and the filter. Heat dissipation is a value for the filter. For further information please contact your local ABB office.

³⁾ For further information please contact your local ABB office.

Sine filters for single drive modules, ACS880-04XT

ACS880-04XT uses the same sine filters as ACS880-04, except two filters are needed: one filter for each drive module.

Sine filters for module packages, ACS880-01/14/34 and multidrive modules, ACS880-104

Sine filters are available also for ACS880-04/14/34 high power single drive module packages and for ACS880-104 multidrive modules. Please contact your local ABB office for further information.

Brake options

—
01 Brake resistor,
SACE15RE13

Brake chopper

Brake chopper handles the energy generated by a decelerating motor. The chopper connects the brake resistor to the DC bus whenever the voltage in the bus exceeds the limit defined by the control program. Energy consumption by the resistor losses lowers the voltage until the resistor can be disconnected. For ACS880 the brake chopper is either built-in as standard or offered as an internal or external option:

Brake resistor

The brake resistors (JBR, SACE, SAFUR) are separately available for ACS880 drive modules. Resistors other than the standard option resistors may be used, provided that the specified resistance value is not decreased and that the heat dissipation capacity of the resistor is sufficient for the drive application.

—
01



ACS880 type (frame sizes)	Brake chopper		
	Built-in as standard	Internal option	External option
-01 (R1 to R4)	X		
-01 (R5 to R9)		X	
-04/04F (R10, R11)		X	
-04XT (2×R10/11)		X	
-11/14/31/34 (R3 to R8, R11)			X ^{*)}
-04/14/34 (n×R8i)			X
-X04			X

^{*)} For more information, please contact your local ABB office.

Brake resistor	Height (mm)	Width (mm)	Depth (mm)	Weight (kg)
JBR-03	124	340	77	0.8
SACE08RE44	365	290	131	6.1
SACE15RE22	365	290	131	6.1
SACE15RE13	365	290	131	6.8
SAFUR80F500	600	300	345	14
SAFUR90F575	600	300	345	12
SAFUR125F500	1320	300	345	25
SAFUR200F500	1320	300	345	30

Brake options, ACS880-01

$U_N = 230 \text{ V}$ (range 208 to 240 V)								
Braking power		Type	Brake resistor(s)			Drive type	Frame size	
P_{brcont} (kW)	R_{min} (ohm)		R (ohm)	E_f (kJ)	P_{rcont} (kW)			
0.75	65	JBR-03	80	40	0.14	ACS880-01-04A6-2	R1	
1.1	65	JBR-03	80	40	0.14	ACS880-01-06A6-2	R1	
1.5	65	JBR-03	80	40	0.14	ACS880-01-07A5-2	R1	
2.2	65	JBR-03	80	40	0.14	ACS880-01-10A6-2	R1	
4	18	SACE15RE22	22	420	2	ACS880-01-16A8-2	R2	
5.5	18	SACE15RE22	22	420	2	ACS880-01-24A3-2	R2	
7.5	13	SACE15RE13	13	435	2	ACS880-01-031A-2	R3	
11	12	SACE15RE13	13	435	2	ACS880-01-046A-2	R4	
11	12	SACE15RE13	13	435	2	ACS880-01-061A-2	R4	
18.5	6	SAFUR90F575	8	1800	4.5	ACS880-01-075A-2+D150	R5	
22	6	SAFUR90F575	8	1800	4.5	ACS880-01-087A-2+D150	R5	
30	3.5	SAFUR125F500	4	3600	9	ACS880-01-115A-2+D150	R6	
37	3.5	SAFUR125F500	4	3600	9	ACS880-01-145A-2+D150	R6	
45	2.4	SAFUR200F500	2.7	5400	13.5	ACS880-01-170A-2+D150	R7	
55	2.4	SAFUR200F500	2.7	5400	13.5	ACS880-01-206A-2+D150	R7	
75	1.8	SAFUR200F500	2.7	5400	13.5	ACS880-01-274A-2+D150	R8	

$U_N = 400\text{ V}$ (range 380 to 415 V)

Braking power		Type	R (ohm)	Brake resistor(s)		Drive type	Frame size
P_{brcont} (kW)	R_{min} (ohm)			E_r (kJ)	P_{rcont} (kW)		
0.75	78	JBR-03	80	40	0.14	ACS880-01-02A4-3	R1
1.1	78	JBR-03	80	40	0.14	ACS880-01-03A3-3	R1
1.5	78	JBR-03	80	40	0.14	ACS880-01-04A0-3	R1
2.2	78	JBR-03	80	40	0.14	ACS880-01-05A6-3	R1
3	78	JBR-03	80	40	0.14	ACS880-01-07A2-3	R1
4	78	JBR-03	80	40	0.14	ACS880-01-09A4-3	R1
5.5	78	JBR-03	80	40	0.14	ACS880-01-12A6-3	R1
7.5	39	SACE08RE44	44	210	1	ACS880-01-017A-3	R2
11	39	SACE08RE44	44	210	1	ACS880-01-025A-3	R2
15	19	SACE15RE22	22	420	2	ACS880-01-032A-3	R3
18.5	19	SACE15RE22	22	420	2	ACS880-01-038A-3	R3
22	13	SACE15RE13	13	435	2	ACS880-01-045A-3	R4
22	13	SACE15RE13	13	435	2	ACS880-01-061A-3	R4
37	8	SAFUR90F575	8	1800	4.5	ACS880-01-072A-3+D150	R5
45	8	SAFUR90F575	8	1800	4.5	ACS880-01-087A-3+D150	R5
55	5.4	SAFUR80F500	6	2400	6	ACS880-01-105A-3+D150	R6
75	5.4	SAFUR80F500	6	2400	6	ACS880-01-145A-3+D150	R6
90	3.3	SAFUR125F500	4	3600	9	ACS880-01-169A-3+D150	R7
110	3.3	SAFUR125F500	4	3600	9	ACS880-01-206A-3+D150	R7
132	2.3	SAFUR200F500	2.7	5400	13.5	ACS880-01-246A-3+D150	R8
132	2.3	SAFUR200F500	2.7	5400	13.5	ACS880-01-293A-3+D150	R8
160	2	SAFUR200F500	2.7	5400	13.5	ACS880-01-363A-3+D150	R9
160	2	SAFUR200F500	2.7	5400	13.5	ACS880-01-430A-3+D150	R9

 $U_N = 500\text{ V}$ (range 380 to 500 V)

Braking power		Type	R (ohm)	Brake resistor(s)		Drive type	Frame size
P_{brcont} (kW)	R_{min} (ohm)			E_r (kJ)	P_{rcont} (kW)		
0.75	78	JBR-03	80	40	0.14	ACS880-01-02A1-5	R1
1.1	78	JBR-03	80	40	0.14	ACS880-01-03A0-5	R1
1.5	78	JBR-03	80	40	0.14	ACS880-01-03A4-5	R1
2.2	78	JBR-03	80	40	0.14	ACS880-01-04A8-5	R1
3	78	JBR-03	80	40	0.14	ACS880-01-05A2-5	R1
4	78	JBR-03	80	40	0.14	ACS880-01-07A6-5	R1
5.5	78	JBR-03	80	40	0.14	ACS880-01-11A0-5	R1
7.5	39	SACE08RE44	44	210	1	ACS880-01-014A-5	R2
11	39	SACE08RE44	44	210	1	ACS880-01-021A-5	R2
15	19	SACE15RE22	22	420	2	ACS880-01-027A-5	R3
18.5	19	SACE15RE22	22	420	2	ACS880-01-034A-5	R3
22	13	SACE15RE13	13	435	2	ACS880-01-040A-5	R4
22	13	SACE15RE13	13	435	2	ACS880-01-052A-5	R4
37	8	SAFUR90F575	8	1800	4.5	ACS880-01-065A-5+D150	R5
45	8	SAFUR90F575	8	1800	4.5	ACS880-01-077A-5+D150	R5
55	5.4	SAFUR80F500	6	2400	6	ACS880-01-096A-5+D150	R6
75	5.4	SAFUR80F500	6	2400	6	ACS880-01-124A-5+D150	R6
90	3.3	SAFUR125F500	4	3600	9	ACS880-01-156A-5+D150	R7
110	3.3	SAFUR125F500	4	3600	9	ACS880-01-180A-5+D150	R7
132	2.3	SAFUR200F500	2.7	5400	13.5	ACS880-01-240A-5+D150	R8
132	2.3	SAFUR200F500	2.7	5400	13.5	ACS880-01-260A-5+D150	R8
160	2.3	SAFUR200F500	2.7	5400	13.5	ACS880-01-361A-5+D150	R9
160	2.3	SAFUR200F500	2.7	5400	13.5	ACS880-01-414A-5+D150	R9
200	2.3	SAFUR200F500	2.7	5400	13.5	ACS880-01-441A-5+D150	R9

$U_N = 690 \text{ V}$ (range 525 to 690 V)									
Braking power		Type				Brake resistor(s)		Drive type	Frame size
P_{brcont} (kW)	R_{min} (ohm)		R (ohm)	E_r (kJ)	P_{rcont} (kW)				
5.5	44	SACE08RE44	44	210	1	ACS880-01-07A4-7	R3		
7.5	44	SACE08RE44	44	210	1	ACS880-01-09A9-7	R3		
11	44	SACE08RE44	44	210	1	ACS880-01-14A3-7	R3		
15	44	SACE08RE44	44	210	1	ACS880-01-019A-7	R3		
18.5	44	SACE08RE44	44	210	1	ACS880-01-023A-7	R3		
22	44	SACE08RE44	44	210	1	ACS880-01-027A-7	R3		
6	18	SACE08RE44	44	210	1	ACS880-01-07A3-7+D150	R5		
8	18	SACE08RE44	44	210	1	ACS880-01-09A8-7+D150	R5		
11	18	SACE08RE44	44	210	1	ACS880-01-14A2-7+D150	R5		
17	18	SACE15RE22	22	420	2	ACS880-01-018A-7+D150	R5		
23	18	SACE15RE22	22	420	2	ACS880-01-022A-7+D150	R5		
28	18	SACE15RE22	22	420	2	ACS880-01-026A-7+D150	R5		
33	18	SACE15RE22	22	420	2	ACS880-01-035A-7+D150	R5		
45	18	SACE15RE22	22	420	2	ACS880-01-042A-7+D150	R5		
45	18	SACE15RE22	22	420	2	ACS880-01-049A-7+D150	R5		
55	13	SACE15RE13	13	435	2	ACS880-01-061A-7+D150	R6		
65	13	SACE15RE13	13	435	2	ACS880-01-084A-7+D150	R6		
90	8	SAFUR90F575	8	1800	4.5	ACS880-01-098A-7+D150	R7		
110	8	SAFUR90F575	8	1800	4.5	ACS880-01-119A-7+D150	R7		
132	6	SAFUR80F500	6	2400	6	ACS880-01-142A-7+D150	R8		
160	6	SAFUR80F500	6	2400	6	ACS880-01-174A-7+D150	R8		
200	4	SAFUR125F500	4	3600	9	ACS880-01-210A-7+D150	R9		
200	4	SAFUR125F500	4	3600	9	ACS880-01-271A-7+D150	R9		

All brake resistors are to be installed outside the converter module. The JBR brake resistors are built-in to an IP20 metal housing. The SACE brake resistors are built-in to an IP21 metal housing. The SAFUR brake resistors are built-in to an IP00 metal frame.

Ratings

P_{brcont}	Continuous brake chopper power. The value applies to the minimum resistance value. With a higher resistance value, the P_{brcont} may increase in some ACS880 units.
R	Resistance value for the listed resistor type.
R_{min}	Minimum allowable resistance value for the brake resistor.
E_r	Energy pulse that the resistor assembly will withstand (400 s duty cycle). This energy will heat the resistor element from 40 °C to the maximum allowable temperature.
P_{rcont}	Continuous power (heat) dissipation of the resistor when placed correctly. Energy E_r dissipates in 400 seconds.

Brake options ACS880-04XT/04FXT

ACS880-04XT uses the same brake options as ACS880-04. The ACS880-04 brake option values are for one module. As ACS880-04XT has two modules, the values need be multiplied by 2.

ACS880-04FXT uses same brake options as ACS880-04F. ACS880-04F brake option values are for one module. As ACS880-04FXT has two, three or four modules, the values need be multiplied by 2, 3 or 4.

Brake options, ACS880-04, ACS880-04F and ACS880-X04

$U_N = 400\text{ V (range 380 to 415 V)}$									
Braking power		Type	R (ohm)	Brake resistor(s)			Drive type	Frame size	
P_{brcont} (kW)	R_{min} (ohm)			E_r (kJ)	P_{rcont} (kW)				
250	2.0	2×SAFUR125F500	2.0	7200	18	ACS880-04/04F-505A/504A-3	R10/R11		
315	1.3	2×SAFUR200F500	1.35	10800	27	ACS880-04/04F-585A/584A-3	R10/R11		
315	1.3	2×SAFUR200F500	1.35	10800	27	ACS880-04/04F-650A/649A-3	R10/R11		
400	0.7	3×SAFUR200F500	0.9	16200	40	ACS880-04/04F-725A-3	R11		
400	0.7	3×SAFUR200F500	0.9	16200	40	ACS880-04/04F-820A-3	R11		
400	0.7	3×SAFUR200F500	0.9	16200	40	ACS880-04/04F-880A-3	R11		

$U_N = 500\text{ V (range 380 to 500 V)}$									
Braking power		Type	R (ohm)	Brake resistor(s)			Drive type	Frame size	
P_{brcont} (kW)	R_{min} (ohm)			E_r (kJ)	P_{rcont} (kW)				
250	2.0	2×SAFUR125F500	2.0	7200	18	ACS880-04/04F-460A/459A-5	R10/R11		
250	2.0	2×SAFUR125F500	2.0	7200	18	ACS880-04/04F-503A/502A-5	R10/R11		
315	1.3	2×SAFUR200F500	1.35	10800	27	ACS880-04/04F-583A/582A-5	R10/R11		
315	1.3	2×SAFUR200F500	1.35	10800	27	ACS880-04/04F-635A/634A-5	R10/R11		
400	0.7	3×SAFUR200F500	0.9	16200	40	ACS880-04/04F-715A-5	R11		
400	0.7	3×SAFUR200F500	0.9	16200	40	ACS880-04/04F-820A-5	R11		
400	0.7	3×SAFUR200F500	0.9	16200	40	ACS880-04/04F-880A-5	R11		

$U_N = 690\text{ V (range 525 to 690 V)}$									
Braking power		Type	R (ohm)	Brake resistor(s)			Drive type	Frame size	
P_{brcont} (kW)	R_{min} (ohm)			E_r (kJ)	P_{rcont} (kW)				
285	2.2	SAFUR200F500	2.7	3600	13	ACS880-04/04F-330A/329A-7	R10/R11		
285	2.2	SAFUR200F500	2.7	3600	13	ACS880-04/04F-370A/369A-7	R10/R11		
285	2.2	SAFUR200F500	2.7	3600	13	ACS880-04/04F-430A/429A-7	R10/R11		
350	2.0	2×SAFUR125F500	2.0	7200	18	ACS880-04/04F-470A-7	R11		
350	2.0	2×SAFUR125F500	2.0	7200	18	ACS880-04/04F-522A-7	R11		
400	1.8	2×SAFUR125F500	2.0	7200	18	ACS880-04/04F-590A-7	R11		
400	1.8	2×SAFUR125F500	2.0	7200	18	ACS880-04/04F-650A-7	R11		
400	1.8	2×SAFUR125F500	2.0	7200	18	ACS880-04/04F-721A-7	R11		

$U_N = 400\text{ V (range 380 to 415 V)}$													
Nominal ratings				Duty cycle (1min/5min)		Duty cycle (10s/60s)		Noise dB(A)	Air flow (m ³ /h)	Brake chopper module type	Brake resistor type	Brake chopper unit type	
P_{brmax} (kW)	R_{min} (ohm)	I_{max} (A)	I_{rms} (A)	P_{cont} (kW)	P_{br} (kW)	I_{rms} (A)	P_{br} (kW)						I_{rms} (A)
Brake chopper without brake resistor													
230	1.7	384	109	70	230	355	230	355	64	660	NBRA658	–	ACS880-604-0210-3
353	1.2	545	149	96	303	468	353	545	64	660	NBRA659	–	ACS880-604-0320-3
706	0.6	1090	298	192	606	936	706	1090	67	1320	2×NBRA659	–	ACS880-604-0640-3
1058	0.4	1635	447	288	909	1404	1059	1635	68	1980	3×NBRA659	–	ACS880-604-0960-3
1411	0.3	2180	596	384	1212	1872	1412	2180	69	2640	4×NBRA659	–	ACS880-604-1280-3
1764	0.24	2725	745	480	1515	2340	1765	2725	70	3300	5×NBRA659	–	ACS880-604-1600-3
2117	0.2	3270	894	576	1818	2808	2118	3270	71	3960	6×NBRA659	–	ACS880-604-1920-3
Brake chopper with the resistor													
230	1.7	384	65	42	130	200	224	346	66	2500	NBRA658	2×SAFUR210F575	ACS880-604-0210-3
353	1.2	545	84	54	167	257	287	444	66	2500	NBRA659	2×SAFUR180F460	ACS880-604-0320-3
706	0.6	1090	168	108	333	514	575	888	69	5000	2×NBRA659	2×(2×SAFUR180F460)	ACS880-604-0640-3
1058	0.4	1635	252	162	500	771	862	1332	70	7500	3×NBRA659	3×(2×SAFUR180F460)	ACS880-604-0960-3
1411	0.3	2180	336	216	667	1028	1150	1776	71	10000	4×NBRA659	4×(2×SAFUR180F460)	ACS880-604-1280-3
1764	0.24	2725	420	270	833	1285	1437	2220	72	12500	5×NBRA659	5×(2×SAFUR180F460)	ACS880-604-1600-3
2117	0.2	3270	504	324	1000	1542	1724	2664	73	15000	6×NBRA659	6×(2×SAFUR180F460)	ACS880-604-1920-3

$U_N = 500 \text{ V}$ (range 380 to 500 V)													
Nominal ratings					Duty cycle (1min/5min)		Duty cycle (10s/60s)		Noise dB(A)	Air flow (m ³ /h)	Brake chopper module type	Brake resistor type	Brake chopper unit type
P_{brmax} (kW)	R_{min} (ohm)	I_{max} (A)	I_{rms} (A)	P_{cont} (kW)	P_{br} (kW)	I_{rms} (A)	P_{br} (kW)	I_{rms} (A)					
Brake chopper without brake resistor													
268	2.15	380	101	81	268	331	268	331	64	660	NBRA658	-	ACS880-604-0260-5
403	1.43	571	136	109	317	391	403	498	64	660	NBRA659	-	ACS880-604-0400-5
806	0.72	1142	272	218	634	782	806	996	67	1320	2×NBRA659	-	ACS880-604-0800-5
1208	0.48	1713	408	327	951	1173	1209	1494	68	1980	3×NBRA659	-	ACS880-604-1200-5
1611	0.36	2284	544	436	1268	1564	1612	1992	69	2640	4×NBRA659	-	ACS880-604-1600-5
2014	0.29	2855	680	545	1585	1955	2015	2490	70	3300	5×NBRA659	-	ACS880-604-2000-5
2417	0.24	3426	816	654	1902	2346	2418	2988	71	3960	6×NBRA659	-	ACS880-604-2400-5
Brake chopper with the resistor													
268	2	408	45	36	111	137	192	237	66	2500	NBRA658	2×SAFUR125F500	ACS880-604-0260-5
403	1.35	605	67	54	167	206	287	355	66	2500	NBRA659	2×SAFUR200F500	ACS880-604-0400-5
806	0.68	1210	134	108	333	412	575	710	69	5000	2×NBRA659	2×(2×SAFUR200F500)	ACS880-604-0800-5
1208	0.45	1815	201	162	500	618	862	1065	70	7500	3×NBRA659	3×(2×SAFUR200F500)	ACS880-604-1200-5
1611	0.34	2420	268	216	667	824	1150	1420	71	10000	4×NBRA659	4×(2×SAFUR200F500)	ACS880-604-1600-5
2014	0.27	3025	335	270	833	1030	1437	1775	72	12500	5×NBRA659	5×(2×SAFUR200F500)	ACS880-604-2000-5
2417	0.23	3630	402	324	1000	1236	1724	2130	73	15000	6×NBRA659	6×(2×SAFUR200F500)	ACS880-604-2400-5

$U_N = 690 \text{ V}$ (range 525 to 690 V)													
Nominal ratings					Duty cycle (1min/5min)		Duty cycle (10s/60s)		Noise dB(A)	Air flow (m ³ /h)	Brake chopper module type	Brake resistor type	Brake chopper unit type
P_{brmax} (kW)	R_{min} (ohm)	I_{max} (A)	I_{rms} (A)	P_{cont} (kW)	P_{br} (kW)	I_{rms} (A)	P_{br} (kW)	I_{rms} (A)					
Brake chopper without brake resistor													
404	2.72	414	107	119	298	267	404	361	64	660	NBRA669	-	ACS880-604-0400-7
807	1.36	828	214	238	596	534	808	722	64	660	2×NBRA669	-	ACS880-604-0800-7
1211	0.91	1242	321	357	894	801	1212	1083	64	1320	3×NBRA669	-	ACS880-604-1200-7
1615	0.68	1656	428	476	1192	1068	1616	1444	64	1980	4×NBRA669	-	ACS880-604-1600-7
2019	0.54	2070	535	595	1490	1335	2020	1805	64	2640	5×NBRA669	-	ACS880-604-2000-7
2422	0.45	2484	642	714	1788	1602	2424	2166	64	3300	6×NBRA669	-	ACS880-604-2400-7
Brake chopper with the resistor													
404	1.35	835	97	54	167	149	287	257	66	2500	NBRA669	2×SAFUR200F500	ACS880-604-0400-7
807	0.68	1670	194	108	333	298	575	514	69	5000	2×NBRA669	2×(2×SAFUR200F500)	ACS880-604-0800-7
1211	0.45	2505	291	162	500	447	862	771	70	7500	3×NBRA669	3×(2×SAFUR200F500)	ACS880-604-1200-7
1615	0.34	3340	388	216	667	596	1150	1028	71	10000	4×NBRA669	4×(2×SAFUR200F500)	ACS880-604-1600-7
2019	0.27	4175	485	270	833	745	1437	1285	72	12500	5×NBRA669	5×(2×SAFUR200F500)	ACS880-604-2000-7
2422	0.23	5010	582	324	1000	894	1724	1542	73	15000	6×NBRA669	6×(2×SAFUR200F500)	ACS880-604-2400-7

Heat loss of section with braking resistors is the same as braking power.

Ratings	
P_{brmax}	Maximum short time braking power.
R_{min}	Minimum allowable resistance value for the brake resistor.
E_r	SAFUR resistor nominal braking capacity without forced cooling. Energy pulse that the resistor assembly will withstand (400 s duty cycle). This energy will heat the resistor element from 40 °C to the maximum allowable temperature.
P_{cont}	Maximum continuous braking power. Continuous power (heat) dissipation of the resistor when placed correctly. Energy E_r dissipates in 400 seconds.
I_{max}	Maximum peak current per chopper during braking. Current is achieved with recommended resistor resistance.
I_{rms}	Corresponding rms current per chopper during load cycle.
P_{br}	Braking power during corresponding duty cycle: 1 min/5 min = 1 minute braking with power P_{br} and 4 minutes unload. 10 s/60 s = 10 second braking with power P_{br} and 50 seconds unload.

Dimensions for choppers				
Frame size	Height (mm)	Width (mm)	Depth (mm)	Weight (kg)
NBRA658	584	334	240	26
NBRA659	584	334	240	26
NBRA669	584	334	240	26

Dimensions for resistors				
Frame size	Height mm	Width mm	Depth mm	Weight kg
SAFUR180F460	1320	300	345	32
SAFUR125F500	1320	300	345	25
SAFUR200F500	1320	300	345	30
SAFUR210F575	1320	300	345	27

ACS880-604 3-phase dynamic brake units

$U_N = 400\text{ V}$ (range 380 to 415 V)

Resistor values		Ratings R_{min}								Ratings R_{max}								Brake unit type	Frame size
		No-overload use				Duty cycle (1min/5min)				No-overload use				Duty cycle (1min/5min)					
R_{min}	R_{max}	I_{dc}	I_{rms}	P_{rcont}	I_{max}	I_{dc}	I_{rms}	P_{br}	P_{br}	I_{dc}	I_{rms}	$P_{contmax}$	I_{max}	I_{dc}	I_{rms}	P_{br}	P_{br}		
(ohm)	(ohm)	DC (A)	DC (A)	(kW)	DC (A)	DC (A)	DC (A)	(kW)	(kW)	DC (A)	DC (A)	(kW)	DC (A)	DC (A)	DC (A)	DC (A)	(kW)		
1.7	2.1	781	310	500	370	999	351	640	781	282	500	312	827	291	530	ACS880-604-0500-3	R8i		
1.2	1.4	1171	465	750	555	1499	527	960	1171	424	750	468	1241	436	800	ACS880-604-0750-3	R8i		
1.7	2.1	1562	621	1000	740	1998	702	1290	1562	565	1000	625	1655	581	1060	ACS880-604-1000-3	2×R8i		
1.2	1.4	2342	931	1510	1110	2997	1053	1930	2342	847	1510	937	2482	872	1600	ACS880-604-1510-3	2×R8i		
1.2	1.4	3514	1396	2260	1665	4496	1580	2890	3514	1271	2260	1405	3723	1308	2400	ACS880-604-2260-3	3×R8i		
1.2	1.4	4685	1862	3010	2220	5994	2106	3860	4685	1694	3010	1874	4964	1744	3190	ACS880-604-3010-3	4×R8i		
1.2	1.4	5856	2327	3770	2775	7493	2633	4820	5856	2118	3770	2342	6205	2180	3990	ACS880-604-3770-3	5×R8i		

$U_N = 500\text{ V}$ (range 380 to 500 V)

Resistor values		Ratings R_{min}								Ratings R_{max}								Brake unit type	Frame size
		No-overload use				Duty cycle (1min/5min)				No-overload use				Duty cycle (1min/5min)					
R_{min}	R_{max}	I_{dc}	I_{rms}	P_{rcont}	I_{max}	I_{dc}	I_{rms}	P_{br}	P_{br}	I_{dc}	I_{rms}	$P_{contmax}$	I_{max}	I_{dc}	I_{rms}	P_{br}	P_{br}		
(ohm)	(ohm)	DC (A)	DC (A)	(kW)	DC (A)	DC (A)	DC (A)	(kW)	(kW)	DC (A)	DC (A)	(kW)	DC (A)	DC (A)	DC (A)	DC (A)	(kW)		
2.2	2.6	781	310	630	370	999	351	800	781	284	630	312	835	293	670	ACS880-604-0630-5	R8i		
1.4	1.7	1171	465	940	555	1499	527	1210	1171	430	940	468	1277	449	1030	ACS880-604-0940-5	R8i		
2.2	2.6	1562	621	1260	740	1998	702	1610	1562	568	1260	625	1671	587	1340	ACS880-604-1260-5	2×R8i		
1.4	1.7	2342	931	1880	1110	2997	1053	2410	2342	860	1880	937	2555	898	2060	ACS880-604-1880-5	2×R8i		
1.4	1.7	3514	1396	2830	1665	4496	1580	3620	3514	1289	2830	1405	3832	1347	3080	ACS880-604-2830-5	3×R8i		
1.4	1.7	4685	1862	3770	2220	5994	2106	4820	4685	1719	3770	1874	5110	1795	4110	ACS880-604-3770-5	4×R8i		
1.4	1.7	5856	2327	4710	2775	7493	2633	6030	5856	2149	4710	2342	6387	2244	5140	ACS880-604-4710-5	5×R8i		

$U_N = 690\text{ V}$ (range 525 to 690 V)

Resistor values		Ratings R_{min}								Ratings R_{max}								Brake unit type	Frame size
		No-overload use				Duty cycle (1min/5min)				No-overload use				Duty cycle (1min/5min)					
R_{min}	R_{max}	I_{dc}	I_{rms}	P_{rcont}	I_{max}	I_{dc}	I_{rms}	P_{br}	P_{br}	I_{dc}	I_{rms}	$P_{contmax}$	I_{max}	I_{dc}	I_{rms}	P_{br}	P_{br}		
(ohm)	(ohm)	DC (A)	DC (A)	(kW)	DC (A)	DC (A)	DC (A)	(kW)	(kW)	DC (A)	DC (A)	(kW)	DC (A)	DC (A)	DC (A)	DC (A)	(kW)		
3.0	3.6	781	310	870	370	999	351	1110	781	283	870	312	833	293	920	ACS880-604-0870-7	R8i		
2.0	2.4	1171	465	1300	555	1499	527	1660	1171	425	1300	468	1249	439	1390	ACS880-604-1300-7	R8i		
3.0	3.6	1562	621	1730	740	1998	702	2220	1562	567	1730	625	1665	585	1850	ACS880-604-1730-7	2×R8i		
2.0	2.4	2342	931	2600	1110	2997	1053	3330	2342	850	2600	937	2498	878	2770	ACS880-604-2600-7	2×R8i		
2.0	2.4	3514	1396	3900	1665	4496	1580	4990	3514	1275	3900	1405	3746	1316	4160	ACS880-604-3900-7	3×R8i		
2.0	2.4	4685	1862	5200	2220	5994	2106	6650	4685	1700	5200	1874	4995	1755	5540	ACS880-604-5200-7	4×R8i		
2.0	2.4	5856	2327	6500	2775	7493	2633	8320	5856	2125	6500	2342	6244	2194	6930	ACS880-604-6500-7	5×R8i		

Ratings

Resistor

R_{min}	Minimum allowed resistance value of the brake resistor for one phase of the brake module.
R_{max}	Resistance value of the brake resistor for one phase of the brake module corresponding to the maximum achieved continuous braking power.

Note: Connect one resistor per brake module phase. For example, a brake unit of frame size 2xR8i including two brake modules → 2 x 3 resistors are needed.

Typical ratings for no-overload use

I_{dc}	Total input DC current of brake unit.
I_{rms}	Total rms DC output phase current of brake unit.
I_{max}	Peak brake current (DC) per chopper module phase.
$P_{cont,max}$	Maximum continuous braking power per brake unit.

Cyclic load (1 min/5 min)

I_{dc}	Total input DC current of brake unit during a period of 1 minute with braking power P_{br} .
I_{rms}	Total rms DC current per brake unit phase during a period of 1 minute with braking power P_{br} .
P_{br}	Short term braking power

Dimensions

Frame size	Height (mm)	Width (mm)	Depth (mm)	Weight (kg)
R8i	1397	240	583	125

ACS880-604LC liquid cooled 1-phase brake units

$U_N = 690$ V (range 525 to 690 V)

Nominal ratings					Duty cycle (1min/5min)		Duty cycle (10s/60s)		Losses	Coolant flow rate ¹⁾	Air flow ²⁾	Module type	Brake resistor type	Type
P_{brmax} (kW)	R_{tot} (ohm)	I_{max} (A)	I_{rms} (A)	P_{brcont} (kW)	P_{br} (kW)	I_{rms} (A)	P_{br} (kW)	I_{rms} (A)	P_{loss} (kW)	(l/min)	(m ³ /h)			
Brake chopper without brake resistor														
404	–	414	107	119	298	267	404	361	2.0	1.6	–	NBRW-669C	–	ACS880-604LC-0400-7
807	–	828	214	238	596	534	808	722	4.0	3.2	–	2×NBRW-669C	–	ACS880-604LC-0800-7
1211	–	1242	321	357	894	801	1212	1083	6.0	4.8	–	3×NBRW-669C	–	ACS880-604LC-1200-7
1615	–	1656	428	476	1192	1068	1616	1444	8.0	6.4	–	4×NBRW-669C	–	ACS880-604LC-1600-7
2019	–	2070	535	595	1490	1335	2020	1805	10.0	8.0	–	5×NBRW-669C	–	ACS880-604LC-2000-7
2422	–	2484	642	714	1788	1602	2424	2166	12.0	9.6	–	6×NBRW-669C	–	ACS880-604LC-2400-7

$U_N = 690$ V (range 525 to 690 V)

Nominal ratings					Duty cycle (1min/5min)		Duty cycle (10s/60s)		Coolant flow rate ¹⁾	Air flow ²⁾	Module type	Brake resistor type	Type
P_{brmax} (kW)	R_{tot} (ohm)	I_{max} (A)	I_{rms} (A)	P_{brcont} (kW)	P_{br} (kW)	I_{rms} (A)	P_{br} (kW)	I_{rms} (A)	(l/min)	(m ³ /h)			
Brake chopper with the resistor													
404	1.35	835	97	54	167	149	287	257	1.6	1840	NBRW-669C	2×SAFUR200F500	ACS880-604LC-0400-7
807	0.68	1670	194	108	333	298	575	514	3.2	4340	2×NBRW-669C	2×(2×SAFUR200F500)	ACS880-604LC-0800-7
1211	0.45	2505	291	162	500	447	862	771	4.8	6180	3×NBRW-669C	3×(2×SAFUR200F500)	ACS880-604LC-1200-7
1615	0.34	3340	388	216	667	596	1150	1028	6.4	8020	4×NBRW-669C	4×(2×SAFUR200F500)	ACS880-604LC-1600-7
2019	0.27	4175	485	270	833	745	1437	1285	8.0	9860	5×NBRW-669C	5×(2×SAFUR200F500)	ACS880-604LC-2000-7
2422	0.23	5010	582	324	1000	894	1724	1542	9.6	11700	6×NBRW-669C	6×(2×SAFUR200F500)	ACS880-604LC-2400-7

¹⁾ Coolant flow rate is for the brake chopper module only.

²⁾ Air flow is for the brake resistor only, which is air-cooled.

Dimensions

	Type	Height (mm)	Width (mm)	Depth (mm)	Weight (kg)
Brake chopper	NBRW-669C	583.5	326	192	29
Brake resistor	SAFUR200F500	1320	300	345	32

Ratings

Nominal ratings

P_{brmax}	Maximum short-term (1 min every 10 mins) braking power.
R_{tot}	Total brake resistor resistance of the whole brake unit.
I_{max}	Maximum peak current of the whole brake unit.
I_{rms}	Corresponding rms current per chopper during load cycle.
P_{brcont}	Maximum continuous power rating.

Cyclic load (1 min/5 min)

P_{br}	Maximum braking power, allowed for 1 minute every 5 minutes.
I_{rms}	Total rms current during a period of 1 minute with braking power P_{br} .

Cyclic load (1 min/10 s)

P_{br}	Total rms current during a period of 10 seconds with braking power P_{br} .
I_{rms}	Maximum braking power, allowed for 10 seconds every 60 seconds

Losses

P_{loss}	Power loss conducted to coolant and emitted to air.
------------	---



K

Du/dt filters

Du/dt filtering suppresses inverter output voltage spikes and rapid voltage changes that stress motor insulation. Additionally, du/dt filtering reduces capacitive leakage currents and high-frequency emissions from the motor cable, as well as high-frequency losses and bearing currents in the motor. The need for du/dt filtering depends on the motor insulation. For information on the construction of the motor insulation, consult the manufacturer.

If the motor does not meet the following requirements, the lifetime of the motor might decrease. Insulated N-end (non-driven end) bearings and/or common mode filters are also required for motor bearing currents with motors bigger than 100 kW. For more information, please see the ACS880 hardware manuals.

Please see below for information about how to select a filter according to the motor.

Filter selection table for ACS880

Motor type	Nominal AC supply voltage	Motor insulation system	Requirements for		
			ABB du/dt and common mode filters, insulated N-end motor bearings		
			$P_N < 100$ kW and frame size < IEC 315	100 kW $\leq P_N < 350$ kW or IEC 315 \leq frame size < IEC 400	$P_N \geq 350$ kW or frame size \geq IEC 400
			$P_N < 134$ hp and frame size < NEMA 500	134 hp $\leq P_N < 469$ hp or NEMA 500 \leq frame size \leq NEMA 580	$P_N \geq 469$ hp or frame size \geq NEMA 580
ABB motors					
Random-wound M2__, M3__ and M4__	$U_N \leq 500$ V	Standard	–	+ N	+ N + CMF
	500 V $< U_N \leq 600$ V	Standard	+ du/dt	+ du/dt + N	+ du/dt + N + CMF
		Reinforced	–	+ N	+ N + CMF
	600 V $< U_N \leq 690$ V (cable length ≤ 150 m)	Reinforced	+ du/dt	+ du/dt + N	+ du/dt + N + CMF
Reinforced		–	+ N	+ N + CMF	
Form-wound HX__ and AM__	380 V $< U_N \leq 690$ V	Standard	n/a	+ N + CMF	$P_N < 500$ kW: + N + CMF $P_N \geq 500$ kW: + du/dt + N + CMF
Old ¹⁾ form-wound HX__ and modular	380 V $< U_N \leq 690$ V	Check with the motor manufacturer	+ du/dt with voltages over 500 V + N + CMF	+ du/dt with voltages over 500 V + N + CMF	+ du/dt with voltages over 500 V + N + CMF
Random-wound HX__ and AM__ ²⁾	0 V $< U_N \leq 500$ V	Enamelled wire with fiber glass taping	+ N + CMF	+ N + CMF	+ N + CMF
	500 V $< U_N \leq 690$ V		+ du/dt + N + CMF	+ du/dt + N + CMF	+ du/dt + N + CMF
HPD	Consult the motor manufacturer.				

¹⁾ Manufactured before 1.1.1998.

²⁾ For motors manufactured before 1.1.1998, check for additional instructions with the motor manufacturer.

Non-ABB motors

Random-wound and form-wound	$U_N \leq 420$ V	Standard: $\hat{U}_{LL} = 1300$ V	–	+ N or CMF	+ N + CMF
	420 V $< U_N \leq 500$ V	Standard: $\hat{U}_{LL} = 1300$ V	+ du/dt	+ du/dt + N or + du/dt + CMF	+ du/dt + N + CMF
		Reinforced: $\hat{U}_{LL} = 1600$ V, 0.2 microsecond rise time	–	+ N or CMF	+ N + CMF
	500 V $< U_N \leq 600$ V	Reinforced: $\hat{U}_{LL} = 1600$ V	+ du/dt	+ du/dt + N or + du/dt + CMF	+ du/dt + N + CMF
		Reinforced: $\hat{U}_{LL} = 1800$ V	–	+ N or CMF	+ N + CMF
	600 V $< U_N \leq 690$ V	Reinforced: $\hat{U}_{LL} = 1800$ V	+ du/dt	+ du/dt + N	+ du/dt + N + CMF
Reinforced: $\hat{U}_{LL} = 2000$ V, 0.3 microsecond rise time ³⁾		–	+ N + CMF	+ N + CMF	

³⁾ If the intermediate DC circuit voltage of the drive is increased from the nominal level due to long term resistor braking cycles, check with the motor manufacturer if additional output filters are needed in the applied drive operation range.

The abbreviations used in the table are defined below

Abbr.	Definition
U_N	Nominal AC line voltage.
\hat{U}_{LL}	Peak line-to-line voltage at motor terminals which the motor insulation must withstand.
P_N	Motor nominal power.
du/dt	du/dt filter at the output of the drive. Available from ABB as an optional add-on kit.
CMF	Common mode filter. Depending on the drive type, CMF is available from ABB as a factory-installed option (+208) or as an optional add-on kit.
N	N-end bearing: insulated motor non-drive end bearing.
n/a	Motors of this power range are not available as standard units. Consult the motor manufacturer.



NOCH0016-60



NOCH0016-62



NOCH0016-65



FOCH0610-70

External du/dt filter for ACS880-01, ACS880-11 and ACS880-31

			du/dt filter type															
			Unprotected IP00			Protected to IP22			Protected to IP54									
			NOCH0016-60	NOCH0030-60	NOCH0070-60	NOCH0120-60 ^{*)}	FOCH0260-70	FOCH0320-50	NOCH0016-62	NOCH0030-62	NOCH0070-62	NOCH0120-62	FOCH0260-72	FOCH0320-52	NOCH0016-65	NOCH0030-65	NOCH0070-65	NOCH0120-65
400 V	500 V	690 V	*) 3 filters included, dimensions apply to one filter.															
02A4-3	02A1-5		x						x					x				
03A3-3	03A0-5		x						x					x				
	03A4-5		x						x					x				
04A0-3	04A8-5	07A3-7	x						x					x				
05A6-3	05A2-5	07A4-7	x						x					x				
07A2-3	07A6-5	09A8-7	x						x					x				
09A4-3		09A9-7	x						x					x				
12A6-3	11A0-5	14A2-7	x						x					x				
		14A3-7	x						x					x				
	014A-5	018A-7	x						x					x				
017A-3		019A-7	x						x					x				
	021A-5	022A-7	x						x					x				
		023A-7	x						x					x				
025A-3		026A-7	x						x					x				
		027A-7	x						x					x				
	027A-5			x					x					x				
032A-3	034A-5	035A-7		x					x					x				
038A-3	040A-5	042A-7		x					x					x				
045A-3	052A-5	049A-7		x					x					x				
061A-3				x					x					x				
	065A-5	061A-7			x					x					x			
072A-3	077A-5				x					x					x			
087A-3		084A-7			x					x					x			
105A-3	096A-5	098A-7			x					x					x			
	124A-5	119A-7				x					x							
145A-3	156A-5	142A-7				x					x							
169A-3	180A-5	174A-7				x					x							
206A-3	240A-5	210A-7				x					x							
246A-3	260A-5	271A-7				x					x							
293A-3						x					x							
363A-3	361A-5						x					x						
430A-3	414A-5						x					x						

External du/dt filter for ACS880-04/04F, ACS880-14/34 R11 and ACS880-04XT/04FXT^{*)}

			du/dt filter type							
			400 V	500 V	690 V	FOCH0260-5X	FOCH0320-5X	FOCH0610-7X	FOCH0875-7X	FOCH0260-7X
				240A-5	142A-7					x
				260A-5	174A-7					x
					210A-7					x
					271A-7					x
246A-3							x			
293A-3							x			
363A-3	302A-5							x		
442A-3	361A-5							x		
	414A-5							x		
505A-3	460A-5	330A-7							x	
585A-3	503A-5	370A-7							x	
650A-3		430A-7							x	
		330A-7							x	
		370A-7							x	
	459A-5								x	
	460A-5	425A-7							x	
		430A-7							x	
504A-3	502A-5								x	
505A-3	503A-5	470A-7							x	
584A-3	582A-5								x	
585A-3	583A-5	522A-7							x	
649A-3	634A-5								x	
650A-3	635A-5	590A-7							x	
725A-3	715A-5	650A-7							x	
820A-3	820A-5	721A-7							x	
880A-3	880A-5								x	

^{*)} For ACS880-04XT/FXT one filter per drive module is needed.

Applicability

Separate du/dt filters are available for ACS880-01/04/04F/04XT/04FXT/11/31 and -14/34 R11. Unprotected IP00 filters must be placed into an enclosure that provides an adequate degree of protection.

External du/dt filter for ACS880-104						
ACS880-104						
400 V	500 V	690 V	NOCH0016-60	NOCH0030-60	NOCH0070-60	BOCH-0350A-7
004A8-3	003A6-5	007A3-7	x			
006A0-3	004A8-5	009A8-7	x			
008A0-3	006A0-5	014A2-7	x			
0011A-3	008A0-5		x			
0014A-3	0011A-5		x			
0018A-3	0014A-5		x			
	0018A-5		x			
0025A-3	0025A-5	0018A-7		x		
0030A-5		0022A-7		x		
0035A-3	0035A-5	0027A-7		x		
0044A-3		0035A-7			x	
0050A-3	0050A-5	0042A-7			x	
0061A-3	0061A-5	0052A-7			x	
0078A-3	0078A-5				x	
0094A-3	0094A-5				x	
0100A-3					x	
0140A-3	0110A-5	0062A-7				x
0170A-3	0140A-5	0082A-7				x
0210A-3	0170A-5	0100A-7				x
0250A-3	0200A-5	0130A-7				x
0300A-3	0240A-5	0140A-7				x
0350A-3	0300A-5	0190A-7				x
	0340A-5	0220A-7				x
		0270A-7				x

Dimensions and weights of the du/dt filters				
du/dt filter	Height (mm)	Width (mm)	Depth (mm)	Weight (kg)
BOCH-0350A-7 ²⁾	310	347	256	16
NOCH0016-60	195	140	115	2.4
NOCH0016-62/65	323	199	154	6
NOCH0030-60	215	165	130	4.7
NOCH0030-62/65	348	249	172	9
NOCH0070-60	261	180	150	9.5
NOCH0070-62/65	433	279	202	15.5
NOCH0120-60 ¹⁾	200	154	106	7
NOCH0120-62/65	765	308	256	45
FOCH0260-70	382	340	254	47
FOCH0260-72	900	314	384	73
FOCH0320-50	662	319	293	65
FOCH0320-52	1092	396	413	100
FOCH0610-70	662	319	293	65
FOCH0875-70	662	319	293	65

¹⁾ 3 filters included, dimensions apply to one filter.

²⁾ Values are for three single-phase filters.

All parallel connected ACS880-104 modules in frame size nxR8i and all 690V ACS880-104 modules in frame size 1xR8i and nxR8i have du/dt filters built-in as standard (+E205). Built-in du/dt filters are available as option (+E205) for ACS880-104 modules in frame size 1xR8i ranging from 380 to 500 V. The built-in du/dt filters in R8i modules do not impact the module dimensions.

ACS880 drives are compatible with the wide ABB product offering



Programmable Logic Controllers PLCs

The AC500, AC500-eCo, AC500-S and AC500-XC scalable PLC ranges provide solutions for small, medium and high-end applications. Our AC500 PLC platform offers different performance levels and is the ideal choice for high availability, extreme environments, condition monitoring, motion control or safety solutions.



All-compatible drives portfolio

The all-compatible drives share the same architecture; software platform, tools, user interfaces and options. Yet, there is an optimal drive from the smallest water pump to the biggest cement kiln, and everything in the between.



AC motors

ABB's low voltage AC motors are designed to save energy, reduce operating costs and minimize unscheduled downtime. General performance motors ensure convenience, while process performance motors provide a broad set of motors for the process industries and heavy-duty applications.



Automation Builder Engineering suite

ABB Automation Builder is the software for machine builders and system integrators wanting to automate their machines and systems in a unified and efficient way. Automation Builder connects the engineering tools for PLC, safety, control panels, SCADA, drives, motion and robots.



Control panels

CP600-eCo, CP600 and CP600-Pro control panels offer a wide range of features and functionalities for maximum operability. ABB control panels are distinguished by their robustness and easy usability, providing all the relevant information from production plants and machines at one single touch.



Jokab safety products

ABB Jokab Safety offers an extensive range of innovative products and solutions for machine safety systems. It is represented in standardization organizations for machine safety and works daily with the practical application of safety requirements in combination with production requirements.

Choose the right motor for your application

Induction motors and the ACS880: a reliable combination

Induction motors are used throughout industry in applications that demand robust and high enclosure motor and drive solutions. ACS880 drives fit perfectly together with this type of motor by providing comprehensive functionality, yet simple operation. The drives are ideal for environments that require a high degree of protection and small footprint. ACS880 drives come with DTC as standard, ensuring high-speed accuracy. Our motors and drives provide the perfect foundation for energy efficiency, while delivering capabilities such as exceeding the nominal motor speed when maximum power is needed.

Our low voltage motors for explosive atmospheres and low voltage industrial drives have been tested and certified to verify that, when correctly dimensioned, they are safe to use in explosive atmospheres. ABB drives can also be used with non-ABB Ex motors with ATEX-certified thermistor protection. If this protection is not used, the motor and drive combination must be either type-tested or combined-tested for potentially explosive atmospheres by the customer, motor manufacturer or a third party. It is also important to verify that the motor can be used with ABB variable speed drives.

Permanent magnet motors and the ACS880: smooth operation

Permanent magnet technology is used for improved motor characteristics in terms of energy efficiency and compactness. This technology is particularly well-suited for low-speed control applications, as in some cases it eliminates the need to use gearboxes. The actual characteristics of different permanent magnet motors can vary considerably. Even without speed or rotor position sensors, ACS880 drives with DTC can control most types of permanent magnet motors.

IE4 synchronous reluctance motors and the ACS880: optimized energy efficiency

Combining the ACS880's control technology with our synchronous reluctance (SynRM) motors provides an IE4 motor and drive package that ensures high energy efficiency, reduces motor temperatures and provides a significant reduction in motor noise. Lower temperature results in better motor reliability and longer motor life.

ABB has tested our SynRM motor and drive packages and produced manufacturer's statements providing verified system (drive and motor) efficiency.



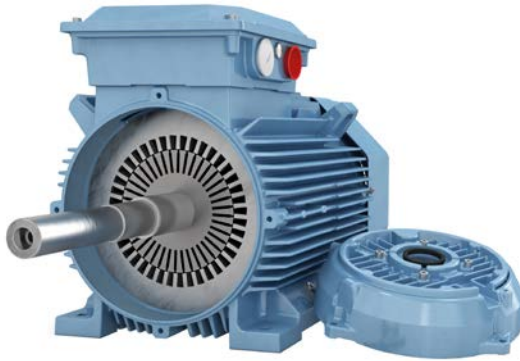

Traditional IE2 induction motor



IE4 synchronous reluctance motor SynRM

Losses

Induction motor	I^2R Stator	Other	I^2R Rotor	100%
SynRM	I^2R Stator	Other		60%

The idea is simple. Take a conventional, proven stator technology and a totally new, innovative rotor design. Then combine them with a drive loaded with new, application-specific software. Finally, optimize the whole package for applications such as pumps, fans, compressors, extruders, conveyors and mixers.

Synchronous reluctance technology combines the performance of a permanent magnet motor with the simplicity and service-friendliness of an induction motor. The new rotor has neither magnets nor windings and suffers virtually no

power losses. Because the footprints are identical, it is easy to replace an induction motor with a SynRM motor.

IE4 synchronous reluctance motors have very low winding temperatures, which increases the reliability and life of the winding. More importantly, the cooler synchronous reluctance rotor means significantly lower bearing temperatures – an important factor, because bearing failures cause about 70% of unplanned motor outages.



Keep your process running

From spare parts and technical support to cloud-based remote monitoring solutions, ABB offers the most extensive service offering to fit your needs. The global ABB service units complemented by external authorized value providers form a service network on your doorstep. Maximize performance, uptime and efficiency throughout the life cycle of your assets.

We can help you more by knowing where you are, register your drive at www.abb.com/drivereg.

Option code	Description
+P904	Extension of warranty to 24 months from commissioning or 30 months from delivery
+P909	Extension of warranty to 36 months from commissioning or 42 months from delivery
+P911	Extension of warranty to 66 months from delivery

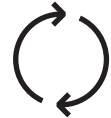

Replacements
Fast and efficient replacement services to minimize production downtime.



End-of-life services
Responsible dismantling, recycling and reusing of products, according to local laws and industrial standards.



Maintenance
Systematic and organized maintenance and support over the life cycle of your assets.



Z



ABB Ability™ Digital Powertrain

1 Intelligent powertrain

The powertrain is equipped with sensors and cloud connectivity and can comprise motors, drives, mechanical components including bearings, couplings and gearboxes – and also pumps. You can choose yourself what assets you want to monitor.

2 Turning data into valuable information

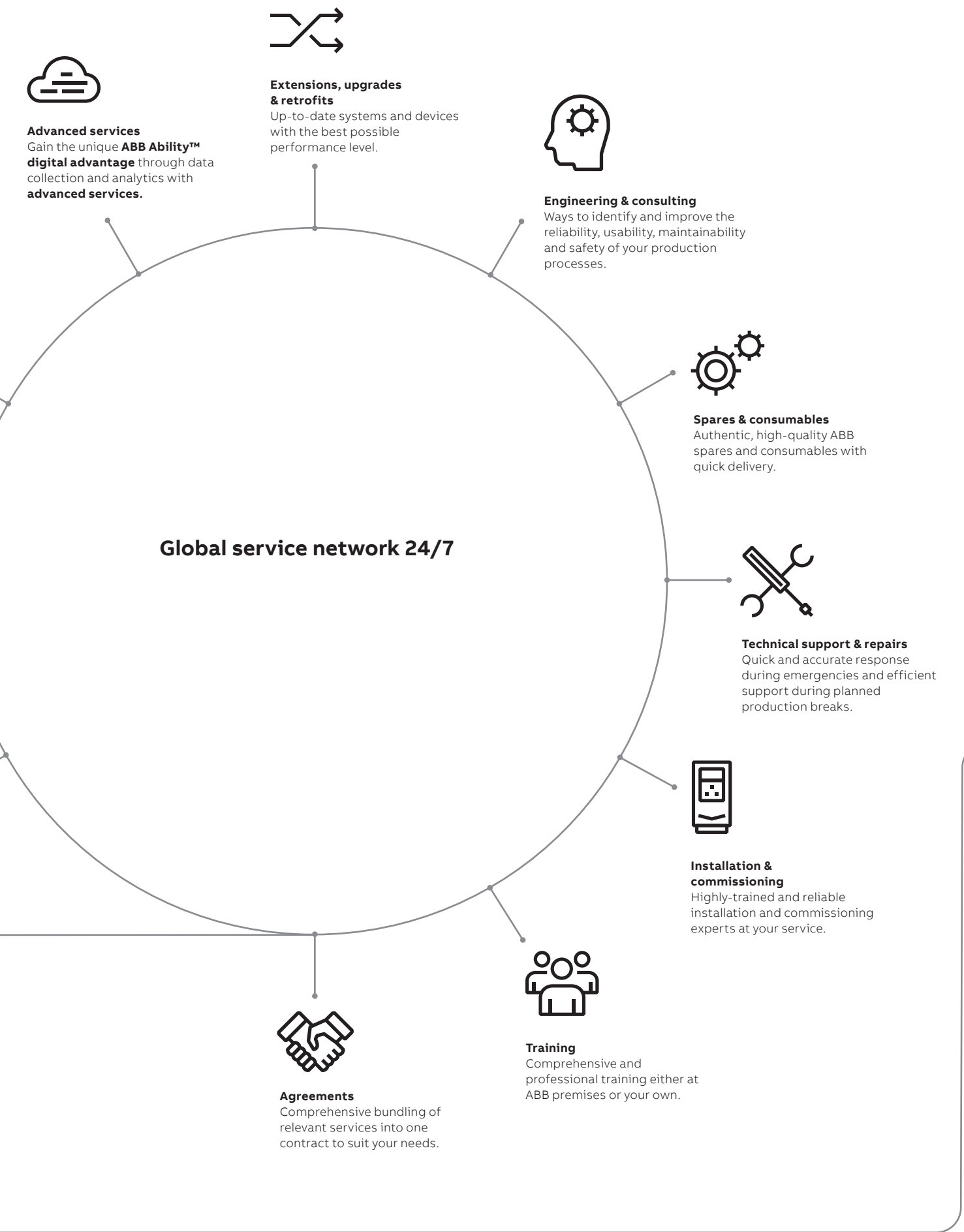
Data gathered from drives' inbuilt sensors and loggers together with that collected from ABB Ability™ Smart Sensors fitted to motors, bearings and pumps, can be aggregated, stored and further accessed via the cloud. The ability to gather and analyze this data can reveal information on the status and condition of your equipment, so that you can schedule service activities more effectively.



ABB Ability™ Condition Monitoring service for powertrains optimizes the performance and efficiency of rotating equipment. It enables full transparency on key parameters for drives, motors, mounted bearings and pumps, and can also be used in applications such as compressors, conveyors, mixers and extruder main shafts.

3 Accessing data for analytics

You have access to a monitoring portal to view key operational parameters of individual assets as one unified system. Detailed dashboards give full transparency so that you can take actions that lead to less downtime, extended equipment lifetime, lower costs, safer operations and increased profitability.

4 Gain a digital advantage

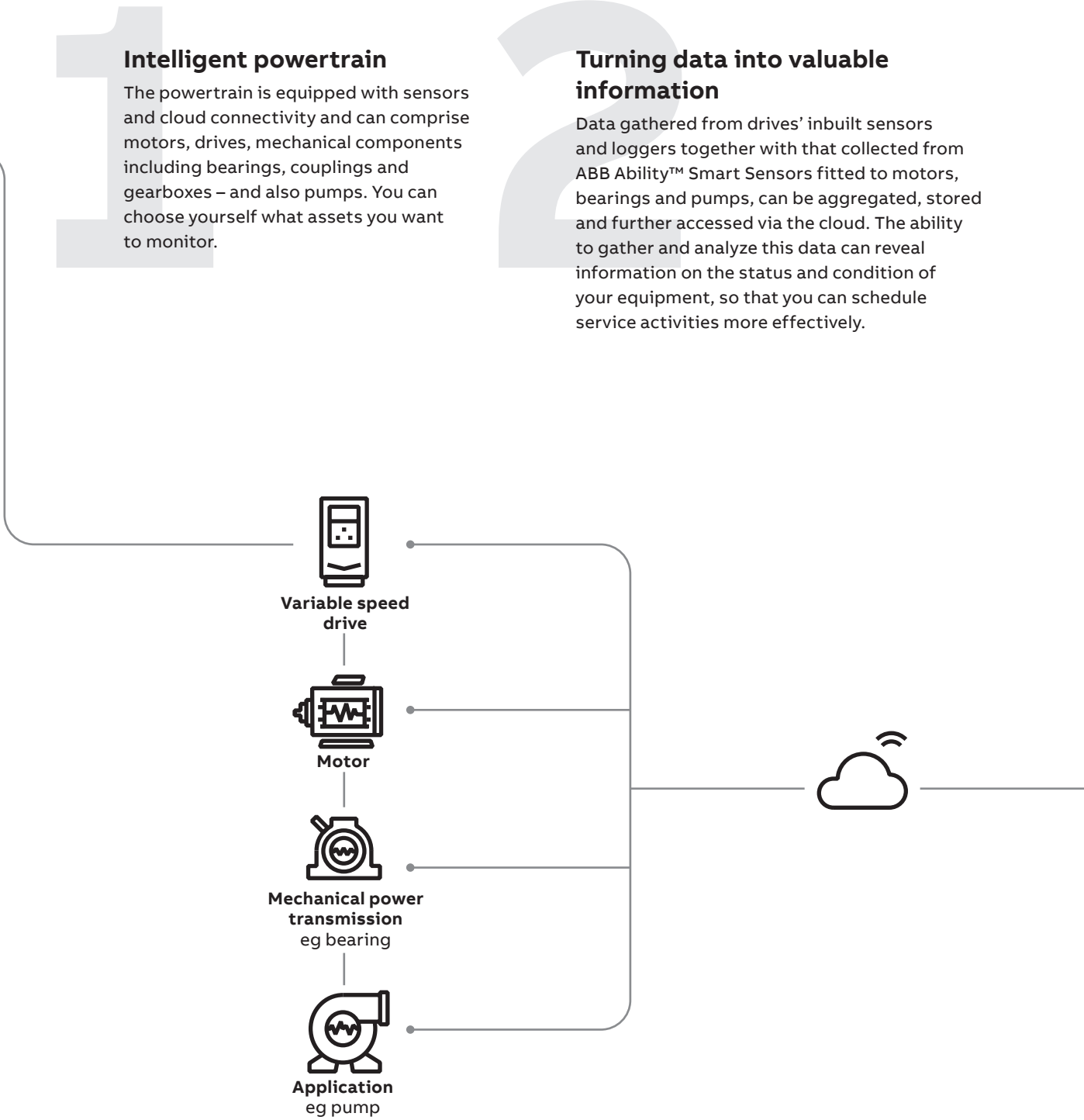
Ensuring that the right person has the right information to at the right time brings:

- Appropriate response to production challenges, minimizing operating costs and wastage of products
- Greater insight into various aspects of your process, thereby improving quality and reducing variations, errors and waste
- Lower risk of production downtime and change of the maintenance from reactive to predictive



Summary of features and options

	Ordering code	ACS880-01 +P940/P944 R1 to R9	ACS880-11/31 +P940 R3 to R8	ACS880-04/04F R10 (-04), R11 (-04/04F)	ACS880-04XT 2xR10 to 2xR11	ACS880-04FXT nxR11	ACS880-04 nxDxT + nxR8i	ACS880-14/34 R11	ACS880-14/34 nxR8i + nxR8i
Mounting									
For cabinet mounting	+P940 +P944	□ □	□ –	● ●	● ●	● ●	● ●	● ●	● ●
Mounting direction – bookshelf		●	●	●	●	–	●	●	●
Mounting direction – flat (= sideways)	+C173	–	–	□	■ ¹⁾	●	■ ¹⁾	–	■ ¹⁾
Flange mounting	+C135	□	□	□ ³⁾	–	●	–	–	–
Side by side mounting		●	●	●	●	●	●	●	●
External drive control unit		–	–	●	●	●	●	●	●
Integrated drive control unit	+P905	●	●	□ ⁶⁾	–	–	–	□	–
Installation frames for drive modules		–	–	–	–	–	■ ⁴⁾	–	■
Wheels for easy maneuvering of the module		–	–	● ⁶⁾	●	–	●	●	●
Cabling									
Supply bottom entry (module terminals)		●	●	–	–	–	●	–	●
Supply top entry (module terminals)		–	–	●	●	●	–	●	–
Inverter bottom exit (module terminals)		●	●	●	●	●	●	●	●
DC connection bus bars/terminals	+H356	●	●	□	●	●	■	●	■
Cabling panel for quick module installation/removal	+H381	–	–	□ ⁶⁾	■	–	–	□	–
Quick connectors for motor cables		–	–	–	–	–	□	–	□
Right hand side terminals (180 degrees turn)	+H391	–	–	□ ⁶⁾	■	–	–	–	–
Degree of protection									
IP00 (UL open type)	+0B051	–	–	□	●	●	●	□	●
IP20 (UL open type)		●	●	●	■	■	–	●	–
Motor control									
DTC motor control		●	●	●	●	●	●	●	●
Control panel									
Intuitive control panel		● ⁵⁾	● ⁵⁾	●	■	■	■	●	■
Integrated control panel holder in the drive	+J414	●	●	□ ⁶⁾	–	–	–	□	–
Control panel mounting platform DPMP-01 (flush) / DPMP-02 (surface)	+J410/ +J413	■	■	□	■	■	■	□	■
EMC filters									
EMC 1st environment, restricted distribution, C2, grounded network (TN)	+E202	□ ⁷⁾	□ ⁸⁾	□	■ ⁹⁾	■ ⁹⁾	■ ⁹⁾	–	■ ⁹⁾
EMC 2nd environment, C3, grounded network (TN)	+E200	□ ¹⁰⁾	□	□	□	□	–	– ²⁾	–
EMC 2nd environment, C3, ungrounded network (IT)	+E201	□ ¹²⁾	□	□	□	□	–	– ²⁾	–
Line filter									
AC or DC choke		●	–	●	●	●	●	–	–
Advanced line harmonic filter (LCL)		–	●	–	–	–	–	●	●
Output filter									
Common mode filter	+E208	□	□	□	●	●	●	□ ¹¹⁾	●
Built-in du/dt filters	+E205	–	–	–	–	–	●	–	●
External du/dt filters		■	■	■	■	■	–	■	–
Braking (see braking unit table)									
Brake chopper	+D150	□ ¹³⁾	■	□	□	□	■	¹⁴⁾	■
Brake resistor		■	■	■	■	■	■	¹⁴⁾	■

● Standard

□ Selectable option, with plus code

■ Selectable option, external, no plus code

	Ordering code	ACS880-01 +P940/P944 R1 to R9	ACS880-11/31 +P940 R3 to R8	ACS880-04/04F R10 (-04), R11 (-04/04F)	ACS880-04XT 2xR10 to 2xR11	ACS880-04FXT nxR11	ACS880-04 nxDxT + nxR8i	ACS880-14/34 R11	ACS880-14/34 nxR8i + nxR8i
Software									
Primary control program		●	●	●	●	●	●	●	●
Drive application programming based on IEC 61131-3 using Automation Builder (available for primary control program)	+N8010	□	□	□	□	□	□	□	□
Application control program for winder	+N5000	□	¹⁴⁾	□	□	□	□	¹⁴⁾	□
Application control program for crane	+N5050	□	□	□	□	□	□	□	□
Application control program for winch	+N5100	□	□	–	□	□	□	□	□
Application control program for centrifuge/decanter	+N5150	□	□	□	¹⁴⁾	¹⁴⁾	¹⁴⁾	□	¹⁴⁾
Application control program for PCP pump	+N5200	□	□	□	□	□	□	□	□
Application control program for Rod pump	+N5250	□	□	□	¹⁴⁾	¹⁴⁾	–	□	–
Application control program for test bench	+N5300	□	¹⁴⁾	–	□	□	□	¹⁴⁾	□
Application control program for cooling tower direct drive	+N5350	□	¹⁴⁾	□	–	–	–	¹⁴⁾	–
Application control program for override control	+N5450	□	□	□	□	□	□	□	□
Application control program for spinning and traverse	+N5500	□	¹⁴⁾	□	–	–	–	¹⁴⁾	–
Application control program for chemical industry process control	+N5550	□	¹⁴⁾	□	¹⁴⁾	¹⁴⁾	¹⁴⁾	¹⁴⁾	¹⁴⁾
Application control program for ESP pumps	+N5600	□	□	□	□	□	□	□	□
Application control program for tower cranes	+N5650	□	□	□	–	–	–	□	–
Application control program for position control	+N5700	□	□	□	□	□	□	□	□
Support for asynchronous motor		●	●	●	●	●	●	●	●
Support for permanent magnet motor		●	●	●	●	●	●	●	●
Support for synchronous reluctance motor (SynRM)	+N7502	□	□	□	–	–	–	□	–
High speed license. Allows high speed operation above 598 Hz output frequency.	+N8200	□ ¹⁷⁾	–	□ ¹⁷⁾	□ ¹⁷⁾	□ ¹⁷⁾	□ ¹⁷⁾	–	□ ¹⁷⁾
Auxiliary option kits									
Main circuit electrical components		–	–	–	–	–	■	–	■
Installation accessories for Rittal VX25 cabinets		■	■	■	■	■	■	■	■
Installation accessories for generic cabinets		■	■	■	■	■	■	■	■
IP20, IP42 and IP54 door and roof kits		–	–	■	■	■	■	■	■
Approvals									
CE		●	●	●	●	●	●	●	●
UL, cUL		●	●	●	●	^{14) 17)}	●	●	●
CSA		●	●	●	●	^{14) 17)}	●	●	●
EAC/GOST R ¹⁵⁾		●	●	●	●	^{14) 17)}	●	●	●
RoHS		●	●	●	●	●	●	●	●
RCM		●	●	●	–	–	–	●	–
Marine type approvals ¹⁶⁾	+C132	□ ¹⁶⁾	–	● ⁶⁾	□ ¹⁶⁾	–	□ ¹⁶⁾	–	□ ¹⁶⁾
TÜV nord certificate for safety functions		●	●	●	●	●	●	●	●
ATEX certified safe disconnection function, Ex II (2) GD (notified body: Eurofins)	+Q971	□	□	□	□	□	□	□	□
SEMI F47		●	●	●	●	●	●	●	●

● Standard

□ Selectable option, with plus code

■ Selectable option, external, no plus code

	Ordering code	ACS880-01 +P940/P944 R1 to R9	ACS880-11/31 +P940 R3 to R8	ACS880-04/04F R10 (-04), R11 (-04/04F)	ACS880-04XT 2xR10 to 2xR11	ACS880-04FXT nxR11	ACS880-04 nxDxT + nxR8i	ACS880-14/34 R11	ACS880-14/34 nxR8i + nxR8i
Safety functions ²⁰⁾									
Safe torque off (STO)		●	●	●	●	●	●	●	●
Safety functions module, FSO-12, without encoder, configurable functions: - Safe stop 1 (SS1-t, SS1-r) - Safely-limited speed (SLS) - Safe brake control (SBC) - Safe maximum speed (SMS) - Safe stop emergency (SSE) - Prevention of unexpected start-up (POUS) - Safe torque off (STO)	+Q973	□	□	□	■	■	■	□	■
Safety functions module, FSO-21, with encoder support, configurable functions: - Safe stop 1 (SS1-t, SS1-r) - Safely-limited speed (SLS) - Safe brake control (SBC) - Safe maximum speed (SMS) - Safe stop emergency (SSE) - Prevention of unexpected start-up (POUS) - Safe direction (SDI), requires encoder feedback, FSE-31 - Safe speed monitoring (SSM) - Safe torque off (STO)	+Q972	□	□	□	■	■	■	□	■
Pulse encoder interface module, FSE-31	+L521	□	□	□	■	■	■	□	■
PROFIsafe over PROFINET	+Q982	□	□	□	■	■	■	□	■
PROFIsafe safety functions module, FSPS-21	+Q986	□	□	□	■	■	■	□	■
ATEX certified thermistor protection module, FPTC-02, Ex II (2) GD	+L537 +Q971	□	□	□	■	■	■	□	■
Earth fault protection									
Earth fault monitoring, earthed mains		●	●	●	●	●	●	●	●
<ul style="list-style-type: none"> ● Standard □ Selectable option, with plus code ■ Selectable option, external, no plus code 									

Ordering code	ACS880-01 +P940/P944 R1 to R9	ACS880-11/31 +P940 R3 to R8	ACS880-04/04F R10 (-04), R11 (-04/04F)	ACS880-04XT 2xR10 to 2xR11	ACS880-04FXT nxR11	ACS880-04 nxDxT + nxR8i	ACS880-14/34 R11	ACS880-14/34 nxR8i + nxR8i	
Control connections (I/O) and communications									
2 pcs analog inputs, programmable, galvanically isolated	●	●	●	●	●	●	●	●	
2 pcs analog outputs, programmable	●	●	●	●	●	●	●	●	
6 pcs digital inputs, programmable, galvanically isolated – can be divided into two groups	●	●	●	●	●	●	●	●	
2 pcs digital inputs/outputs	●	●	●	●	●	●	●	●	
1 pcs digital input interlock	●	●	●	●	●	●	●	●	
3 pcs relay outputs programmable	●	●	●	●	●	●	●	●	
Drive-to-drive link/Built-in Modbus	●	●	●	●	●	●	●	●	
Assistant control panel/PC tool connection	●	●	●	●	●	●	●	●	
Possibility for external power supply for control unit	●	●	●	●	●	●	●	●	
Built-in I/O extension and speed feedback modules: for more details see sections: "Input/output extension modules", "Speed feedback interfaces for precise process control" and "DDCS communication option modules" ¹⁸⁾	□	□	□	■	■	■	□	■	
Built-in adapters for several communication protocols: for more details see section "Communication protocol adapters" ¹⁹⁾	□	□	□	■	■	■	□	■	

● Standard

□ Selectable option, with plus code

■ Selectable option, external, no plus code

– Not available

¹⁾ The drive must be installed according to the instructions given in the manuals.²⁾ Available with +E210.³⁾ Only for ACS880-04F⁴⁾ Only for 6-pulse D8T module⁵⁾ Without control panel, +0J400⁶⁾ Not for ACS880-04F⁷⁾ For frame sizes R1 to R9, 380 to 500 V. Not for 690 V.⁸⁾ +E202 for frame size R6: Please contact your local ABB office to check availability.⁹⁾ For 380 to 500 V and only for frame size 1xD8T (-04 module packages) and for frame size 1xR8i (-14/34 module packages)¹⁰⁾ For frame sizes R1 to R9, 380 to 500 V and frame sizes R3 to R9, 690 V.¹¹⁾ As standard for 690 V.¹²⁾ For frame sizes R6 to R9, 380 to 500 V and frame sizes R7 to R9, 690 V.¹³⁾ 2nd environment, C4: Frame sizes R1 to R5, 380 to 500 V and frame sizes R3 to R6, 690 V.¹⁴⁾ Frame sizes R1 to R4 built-in and R5 to R9 as selectable option¹⁵⁾ Pending¹⁶⁾ EAC has replaced GOST R¹⁷⁾ ACS880 marine type approvals and type approved drives are listed at <http://new.abb.com/drives/segments/marine/marine-type-approvals>.¹⁸⁾ For further information, please contact your local ABB office.¹⁸⁾ Three option slots are available for I/O extension, speed feedback, communication protocol and functional safety options.

The slot number for I/O and encoder options can be extended with FEA-03 option.

¹⁹⁾ Three option slots are available for I/O extension, speed feedback, communication protocol and functional safety options.²⁰⁾ Three option slots are available for I/O extension, speed feedback, communication protocol and functional safety options.

FSO-xx can also be mounted on a DIN rail by using a separate installation kit. DIN rail mounting does not consume the drive's option slots. With frames R6 to R11 it is possible to mount the FSO-xx inside the drive without using the drive's option slots.

Ordering code	ACS880-104 INU R1i to nxR8i	ACS880-204 ISU R1i to R4i, R6i and nxR8i	ACS880-304 DSU D6D to D8D	ACS880-304 DSU 2xD7T and nxD8T	ACS880-904 RRU nxR8i	ACS880-604 nxR8i	ACS880-1604 nxR8i	ACS880-104LC nxR8i	ACS880-204LC nxR8i	ACS880-304LC nxR8i	ACS880-1604LC nxR8i	
Mounting												
For cabinet mounting	●	●	●	●	●	●	●	●	●	●	●	●
Mounting direction – bookshelf	●	●	●	●	●	●	●	●	●	●	●	●
Mounting direction – flat (= sideways)	■ ¹⁾	■ ¹⁾	■ ¹⁾	■ ¹⁾	■ ¹⁾	■ ¹⁾	■ ¹⁾	–	–	–	–	–
Flange mounting	–	–	–	–	–	–	–	–	–	–	–	–
Side by side mounting	●	●	–	●	●	●	●	●	●	●	●	●
External drive control unit	● ²⁾	● ²⁾	●	●	●	●	●	●	●	●	●	●
Integrated drive control unit	● ³⁾	● ³⁾	–	–	–	–	–	–	–	–	–	–
Installation frames for drive modules	■ ⁵⁾	■ ⁵⁾	–	■ ⁵⁾	–	–	–	–	–	–	–	–
Wheels for easy maneuvering of the module	● ⁶⁾	● ⁶⁾	● ⁶⁾	● ⁶⁾	●	● ⁶⁾	●	–	–	–	–	–
Cabling												
Supply bottom entry (module terminals)	–	●	●	●	●	●	●	–	●	●	●	●
Supply top entry (module terminals)	–	–	–	–	–	–	–	–	–	–	–	–
Inverter bottom exit (module terminals)	●	–	–	–	–	●	●	●	–	–	●	●
DC connection bus bars/terminals	■ ⁸⁾	■ ⁸⁾	■	■	■	■	■	■	■	■	■	■
Degree of protection												
IP00 (UL open type)	●	●	●	●	●	●	●	●	●	●	●	●
IP20 (UL open type)	–	–	–	–	–	–	–	–	–	–	–	–
Motor control												
DTC motor control	●	–	–	–	–	–	–	●	–	–	–	–
Control panel												
Intuitive control panel	■	■	■	■	■	■	■	■	■	■	■	■
Integrated control panel holder in the drive	– ⁸⁾	– ⁸⁾	–	–	–	–	–	–	–	–	–	–
Control panel mounting platform DPMP-01 (flush) / DPMP-02 (surface)	■	■	■	■	■	■	■	■	■	■	■	■
EMC filters												
EMC 1st environment, restricted distribution, C2, grounded network (TN)	–	■ ¹⁴⁾	–	■ ¹⁴⁾	–	–	–	–	–	–	–	–
EMC 2nd environment, C3, grounded (TN) and ungrounded (IT)	● ¹⁵⁾	● ¹⁵⁾	● ¹⁵⁾	● ¹⁵⁾	● ¹⁵⁾	● ¹⁵⁾	● ¹⁵⁾	● ¹⁵⁾	● ¹⁵⁾	● ¹⁵⁾	● ¹⁵⁾	● ¹⁵⁾
Line filter												
AC or DC choke	–	–	●	●	–	–	–	–	–	–	–	–
Advanced line harmonic filter LCL	–	●	–	–	–	–	–	–	●	–	–	–
L	–	–	–	–	●	–	–	–	–	–	–	–
Output filter												
Common mode filter	● ¹⁶⁾	● ⁹⁾	–	–	●	●	–	●	●	–	–	–
Built-in du/dt filters +E205	□ ⁴⁾	● ⁴⁾	–	–	● ⁴⁾	● ⁴⁾	● ⁴⁾	●	● ⁴⁾	–	● ⁴⁾	● ⁴⁾
External du/dt filters	■	–	–	–	–	–	–	–	–	–	–	–
Braking (see braking unit table)												
Brake chopper	■ ¹⁷⁾	–	–	–	–	●	–	–	–	–	–	–
Brake resistor	■	–	–	–	–	■	–	–	–	–	–	–
Regenerative braking	–	●	–	–	●	–	–	–	●	–	–	–

● Standard

□ Selectable option, with plus code

■ Selectable option, external, no plus code

	Ordering code	ACS880-104 INU R1i to nxR8i	ACS880-204 ISU R1i to R4i, R6i and nxR8i	ACS880-304 DSU D6D to D8D	ACS880-304 DSU 2xD7T and nxD8T	ACS880-904 RRU nxR8i	ACS880-604 nxR8i	ACS880-1604 nxR8i	ACS880-104LC nxR8i	ACS880-204LC nxR8i	ACS880-304LC nxD8D	ACS-1604LC nxR8i
Software												
Primary control program		●	-	-	-	-	-	-	●	-	-	-
Drive application programming based on IEC 61131-3 using Automation Builder	+N8010	□	□	-	-	-	-	-	□	□	-	-
Application control program for winder	+N5000	□	-	-	-	-	-	-	-	-	-	-
Application control program for crane	+N5050	□	-	-	-	-	-	-	□	-	-	-
Application control program for winch	+N5100	□	-	-	-	-	-	-	□	-	-	-
Application control program for centrifuge/decanter	+N5150	- ⁷⁾	-	-	-	-	-	-	-	-	-	-
Application control program for PCP pump	+N5200	□	-	-	-	-	-	-	-	-	-	-
Application control program for Rod pump	+N5250	-	-	-	-	-	-	-	-	-	-	-
Application control program for test bench	+N5300	□	-	-	-	-	-	-	□	-	-	-
Application control program for cooling tower direct drive	+N5350	-	-	-	-	-	-	-	-	-	-	-
Application control program for override control	+N5450	-	-	-	-	-	-	-	-	-	-	-
Application control program for spinning and traverse	+N5500	-	-	-	-	-	-	-	-	-	-	-
Application control program for chemical industry process control	+N5550	- ⁷⁾	-	-	-	-	-	-	-	-	-	-
Application control program for ESP pumps	+N5600	□	-	-	-	-	-	-	-	-	-	-
Application control program for tower cranes	+N5650	-	-	-	-	-	-	-	-	-	-	-
Application control program for position control	+N5700	□	-	-	-	-	-	-	□	-	-	-
Support for asynchronous motor		●	-	-	-	-	-	-	●	-	-	-
Support for permanent magnet motor		●	-	-	-	-	-	-	●	-	-	-
Support for synchronous reluctance motor (SynRM)	+N7502	□	-	-	-	-	-	-	-	-	-	-
Optimal grid control of IGBT supply control program (grid converter)	+N8053	-	□ ^{4) 11)}	-	-	-	-	-	-	□ ^{4) 11)}	-	-
High speed license. Allows high speed operation above 598 Hz output frequency.	+N8200	□ ¹¹⁾	-	-	-	-	-	-	- ⁷⁾	-	-	-
Auxiliary option kits												
Main circuit electrical components		■	■	■	■	■	■	■	■	■	■	■
DC-fuse switch		■	-	-	-	-	-	■	■	■	-	■
Installation accessories for Rittal VX25 cabinet		■	■	■	■	■	■	■	■	■	■	■
Installation accessories for generic cabinets		■	■	■	■	■	■	■	■	■	■	■
IP20, IP42 and IP54 door and roof kits		■	■	■	■	■	■	■	-	-	-	-
Approvals												
CE		●	●	●	●	●	●	●	●	●	●	●
UL, cUL		●	●	●	●	●	●	●	● ⁷⁾	● ⁷⁾	● ⁷⁾	● ⁷⁾
CSA		●	●	●	●	●	●	●	● ⁷⁾	● ⁷⁾	● ⁷⁾	● ⁷⁾
EAC/GOST R ¹⁰⁾		●	●	●	●	●	●	●	● ⁷⁾	● ⁷⁾	● ⁷⁾	● ⁷⁾
RoHS		●	●	●	●	●	●	●	●	●	●	●
RCM		-	-	-	-	-	-	-	-	-	-	-
Marine type approvals ¹⁹⁾	+C132	□ ^{19, 20)}	□ ^{19, 20)}	-	□ ¹⁹⁾	-	□ ¹⁹⁾	□ ¹⁹⁾	□ ¹⁹⁾	□ ¹⁹⁾	□ ¹⁹⁾	□ ¹⁹⁾
TÜV nord certificate for safety functions		●	-	-	-	-	-	-	●	-	-	-
ATEX certified safe disconnection function, Ex II (2) GD (notified body: Eurofins)	+Q971	□	-	-	-	-	-	-	□	-	-	-
SEMI F47		●	●	●	●	●	-	●	●	●	●	●

- Standard
- Selectable option, with plus code
- Selectable option, external, no plus code

Ordering code	ACS880-104 INU R1i to nxR8i	ACS880-204 ISU R1i to R4i, R6i and nxR8i	ACS880-304 DSU D6D to D8D	ACS880-304 DSU 2xD7T and nxD8T	ACS880-904 RRU nxR8i	ACS880-604 nxR8i	ACS880-1604 nxR8i	ACS880-104LC nxR8i	ACS880-204LC nxR8i	ACS880-304LC nxD8D	ACS-1604LC nxR8i
Safety functions ¹³⁾											
Safe torque off (STO)	●	-	-	-	-	-	-	●	-	-	-
Safety functions module, FSO-12, without encoder, configurable functions: - Safe stop 1 (SS1-t, SS1-r) - Safely-limited speed (SLS) - Safe brake control (SBC) - Safe maximum speed (SMS) - Safe stop emergency (SSE) - Prevention of unexpected start-up (POUS) - Safe torque off (STO)	■	-	-	-	-	-	-	■	-	-	-
Safety functions module, FSO-21, with encoder support, configurable functions: - Safe stop 1 (SS1-t, SS1-r) - Safely-limited speed (SLS) - Safe brake control (SBC) - Safe maximum speed (SMS) - Safe stop emergency (SSE) - Prevention of unexpected start-up (POUS) - Safe direction (SDI), requires encoder feedback, FSE-31 - Safe speed monitoring (SSM) - Safe torque off (STO)	■	-	-	-	-	-	-	■	-	-	-
Pulse encoder interface module, FSE-31	■	-	-	-	-	-	-	■	-	-	-
PROFIsafe safety functions module, FSPS-21	■	-	-	-	-	-	-	■	-	-	-
PROFIsafe over PROFINET	■	-	-	-	-	-	-	■	-	-	-
ATEX certified thermistor protection module, Ex II (2) GD	FPTC-02 +Q971 ■	-	-	-	-	-	-	■	-	-	-
Earth fault protection											
Earth fault monitoring, earthed mains	●	●	-	●	●	-	-	●	●	-	-

- Standard
- Selectable option, with plus code
- Selectable option, external, no plus code

Ordering code	ACS880-104 INU R1i to nxR8i	ACS880-204 ISU R4i, R6i and nxR8i	ACS880-304 DSU D6D to D8D	ACS880-304 DSU 2xD7T and nxD8T	ACS880-904 RRU nxR8i	ACS880-604 nxR8i	ACS880-1604 nxR8i	ACS880-104LC nxR8i	ACS880-204LC nxR8i	ACS880-304LC nxD8D	ACS-1604LC nxR8i
Control connections (I/O) and communications											
2 pcs analog inputs, programmable, galvanically isolated	●	●	●	●	●	● ¹²⁾	●	●	●	●	●
2 pcs analog outputs, programmable	●	●	●	●	●	● ¹²⁾	●	●	●	●	●
6 pcs digital inputs, programmable, galvanically isolated – can be divided into two groups	●	●	●	●	●	● ¹²⁾	●	●	●	●	●
2 pcs digital inputs/outputs	●	●	●	●	●	● ¹²⁾	●	●	●	●	●
1 pcs digital input interlock	●	●	●	●	●	● ¹²⁾	●	●	●	●	●
3 pcs relay outputs programmable	●	●	●	●	●	● ¹²⁾	●	●	●	●	●
Drive-to-drive link/Built-in Modbus	●	●	●	●	●	● ¹²⁾	●	●	●	●	●
Assistant control panel/PC tool connection	●	●	●	●	●	● ⁹⁾	●	●	●	●	●
Possibility for external power supply for control unit	●	●	●	●	●	●	●	●	●	●	●
Built-in I/O extension and speed feedback modules: for more details see sections: "Input/output extension modules", "Speed feedback interfaces for precise process control" and "DDCS communication option modules" ¹⁸⁾	■	■	■	■	■	■	■	■	■	■	■
Built-in adapters for several communication protocols: for more details see section "Communication protocol adapters" ²¹⁾	■	■	■	■	■	■	■	■	■	■	■

- Standard
- Selectable option, with plus code
- Selectable option, external, no plus code
- Not available

¹⁾ The drive must be installed according to the instructions given in the manuals.
Possible for frames R6i-R8i, DxD, DxT, BLCL-, BL- and BDCL-filters.

²⁾ R1i to R7i on the module

³⁾ R8i as external

⁴⁾ Only for R8i module.

⁵⁾ Only for R6i-R8i modules, 6-pulse DxT modules and BLCL-filters

⁶⁾ R1i-R7i, D6D, D7D and D7T modules and 1-phase brake chopper without wheels

⁷⁾ Pending

⁸⁾ R1i to R5i as standard

⁹⁾ Available for R8i and R6i

¹⁰⁾ EAC has replaced GOST R

¹¹⁾ For further information, please contact your local ABB office.

¹³⁾ Three option slots are available for I/O extension, speed feedback, communication protocol and functional safety options.
FSO-xx can also be mounted on a DIN rail by using a separate installation kit.
DIN rail mounting does not consume the drives' option slots.

¹²⁾ Not available for 1-phase brake unit.

¹⁴⁾ For 380 to 500 V and for ISU frame sizes up to 1xR8i and for 1xD8T

¹⁵⁾ The standard module fulfills C3 requirements when installed according to the instructions given in the manuals.

¹⁶⁾ Available for R6i to R8i

¹⁷⁾ Internal with R1i to R4i

¹⁸⁾ Three option slots are available for I/O extension, speed feedback, communication protocol and functional safety options.
The slot number for I/O and encoder options can be extended with FEA-03 option.

¹⁹⁾ ACS880 marine type approvals and type approved drives are listed at <http://new.abb.com/drives/segments/marine/marine-type-approvals>.

²⁰⁾ ACS880-104 and ACS880-204 frames R1i-R4i do not have marine type approval (+C132).

²¹⁾ Three option slots are available for I/O extension, speed feedback, communication protocol and functional safety options.



—
For more information, please contact
your local ABB representative or visit

new.abb.com/ACS880
new.abb.com/drives
new.abb.com/drivespartners
new.abb.com/motors-generators

Video playlist:
ACS880 how-to videos

