

SIEMENS

Ingenuity for life

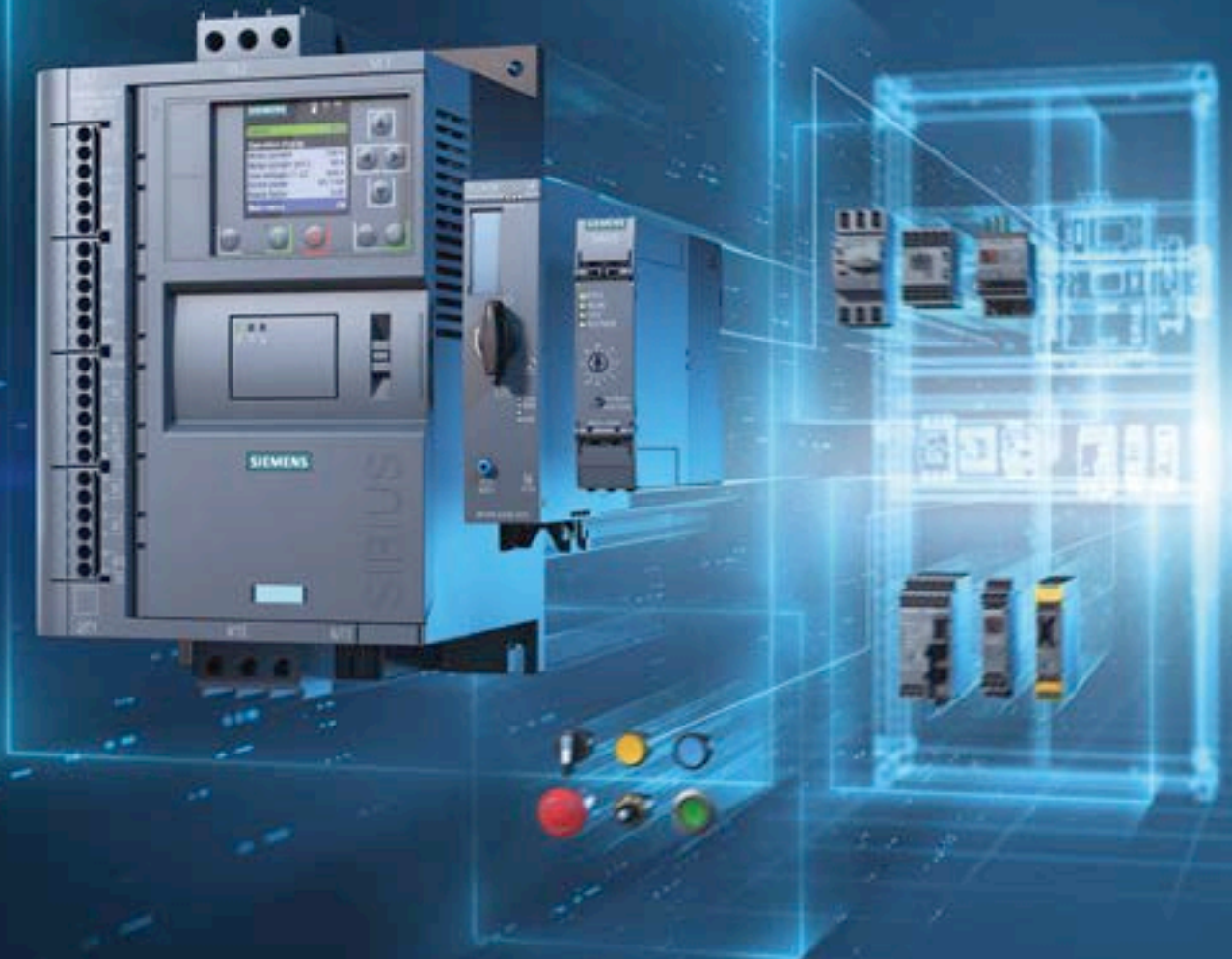

Pioneering SIRIUS hybrid industrial controls

Starting motors with SIRIUS

SIRIUS
Hybrid

[siemens.com/sirius-hybrid](https://www.siemens.com/sirius-hybrid)

Control perfection with SIRIUS industrial controls

SIRIUS, the most modern, complete and innovated range of industrial controls can be subdivided into four core areas. They provide a good overview of the full spectrum of products and their functions.

The most modern technology with a perfect design

The hybrid switching technology combines the best of relay and semiconductor switching technology: The devices switch electronically via the integrated power semiconductor, and then low-loss electromechanical bypass contacts take over the current flow during operation.



SIRIUS Control

- Contactors
- Motor starter protectors
- Overload relay
- Infeed system
- Load feeders
- Reversing contactor assemblies
- Star-delta (wye-delta) combinations
- Contactor relays

SIRIUS Command

- Pushbuttons and indicator lights
- Signaling columns
- Position and safety switches
- Cable-operated switches
- Foot switches
- Integrated signal lamps

SIRIUS Monitor

- Safety relays
- AS-Interface
- SIMOCODE
- Coupling/time/monitoring relay
- Standstill and speed monitor

SIRIUS Hybrid

- 3RW soft starters
- 3RM1 motor starters
- ET 200SP motor starters
- 3RF Solid-state switching devices



The SIRIUS 3RW5 soft starter received the RedDot Design and the iF Design awards thanks to numerous factors, including its slim, coordinated and uniform design across all sizes.

Low-wear switching thanks to hybrid switching technology

The spectrum of the SIRIUS 3RW soft starters ranges from 2-phase controlled devices for standard applications all the way to high-performance 3-phase controlled equipment for demanding tasks. It covers all power ranges from 1.5 to 1200 kW and is therefore ideal for creating cost-optimized and suitable drive solutions for any application. At the same time, users benefit from substantial energy savings in operation. In the **3RW55 high performance range, the failsafe version** is unique. Thus, you are able to reduce costs due to space savings, and fewer components are required. For more information, see www.siemens.com/IC10. For heavy starting, please always use the STS (Simulation Tool for Soft Starters) when selecting; see page 5.

Reduced power losses in operation

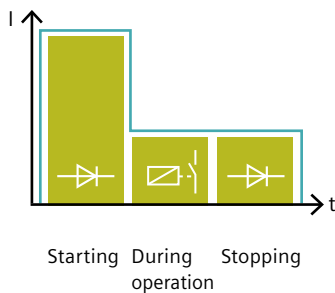

Conventional industrial controls result in wear to the mechanical switching contacts every time a system is switched on or off, albeit in very small increments. This is not the case with hybrid industrial controls, because the starting current is first engaged via electronic contact elements (Thyristor, Triac) and the mechanical contact elements are only engaged when the rated speed is reached. Thus, the mechanical components achieve a significantly higher switching service life.

Advantages at a glance

- Longer service lives for controls
- Economic advantages with increased switching cycles
- Lower energy costs and lower temperature rise in the control panel
- Prevention of current peaks and network voltage dips
- Low interference emission; smaller electrical voltage fluctuations in power systems (flicker)
- Reduced power losses in operation

SIRIUS 3RW soft starters at a glance

High Performance		3RW55 5.5 – 710/1,200 kW ($\sqrt{3}$)	$(\sqrt{3})$	3-phase controlled	TIA integration
		3RW55 Failsafe 5.5 – 315/560 kW ($\sqrt{3}$)			
General Performance		3RW52 5.5 – 315/560 kW ($\sqrt{3}$)	$(\sqrt{3})$	3-phase controlled	TIA integration
Basic Performance		3RW50 75 – 315 kW		2-phase controlled	TIA integration
		3RW40 5.5 – 55 kW			
		3RW30 1.5 – 55 kW			

Typical applications



Pumping



Ventilating



Compressing



Moving



Processing

Good reasons for using soft starters

Motor voltage, current and torque effects differ considerably compared with those experienced in direct-on-line or star-delta (wye-delta) starting: Soft increase of the motor voltage, limited motor current and flat motor torque provide considerable advantages.

- Lower mechanical wear of the drive train due to limitation of the starting current/torque
- Protection of the network voltage from excessive starting peaks by reduced current consumption

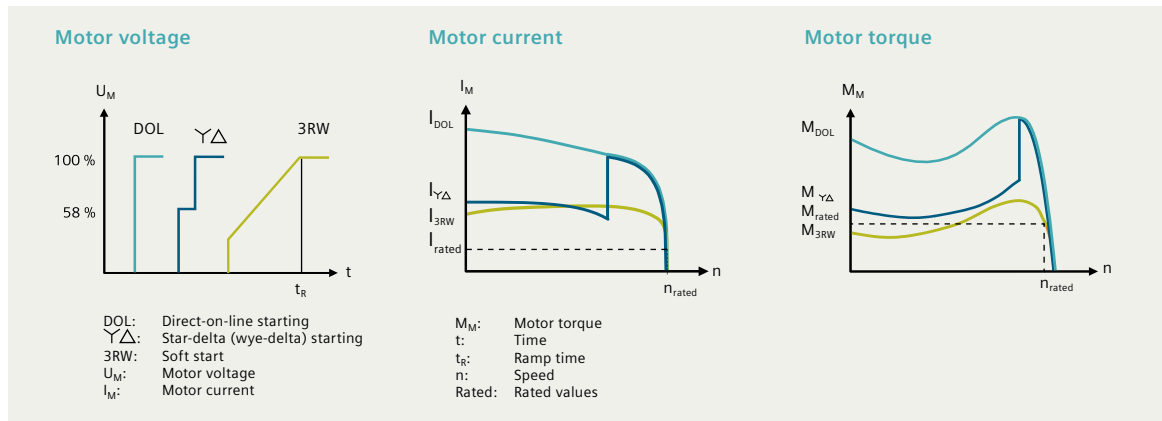

- Considerable savings on wiring in the control panel compared with a contactor assembly for star-delta (wye-delta) starting

Circuit diagram for star-delta (wye-delta) starter

L1 3/N/PE 50Hz 230/400 V
 L2
 L3

W1 W2
 V1 V2
 U1 U2

M
 3 ~

Circuit diagram for soft starter

L1
 L2
 L3
 F1
 QS1
 QS2
 QS3
 QS4
 QS5
 QS6
 QS7
 QS8
 QS9
 QS10
 QS11
 QS12
 QS13
 QS14
 QS15
 QS16
 QS17
 QS18
 QS19
 QS20
 QS21
 QS22
 QS23
 QS24
 QS25
 QS26
 QS27
 QS28
 QS29
 QS30
 QS31
 QS32
 QS33
 QS34
 QS35
 QS36
 QS37
 QS38
 QS39
 QS40
 QS41
 QS42
 QS43
 QS44
 QS45
 QS46
 QS47
 QS48
 QS49
 QS50
 QS51
 QS52
 QS53
 QS54
 QS55
 QS56
 QS57
 QS58
 QS59
 QS60
 QS61
 QS62
 QS63
 QS64
 QS65
 QS66
 QS67
 QS68
 QS69
 QS70
 QS71
 QS72
 QS73
 QS74
 QS75
 QS76
 QS77
 QS78
 QS79
 QS80
 QS81
 QS82
 QS83
 QS84
 QS85
 QS86
 QS87
 QS88
 QS89
 QS90
 QS91
 QS92
 QS93
 QS94
 QS95
 QS96
 QS97
 QS98
 QS99
 QS100
 QS101
 QS102
 QS103
 QS104
 QS105
 QS106
 QS107
 QS108
 QS109
 QS110
 QS111
 QS112
 QS113
 QS114
 QS115
 QS116
 QS117
 QS118
 QS119
 QS120
 QS121
 QS122
 QS123
 QS124
 QS125
 QS126
 QS127
 QS128
 QS129
 QS130
 QS131
 QS132
 QS133
 QS134
 QS135
 QS136
 QS137
 QS138
 QS139
 QS140
 QS141
 QS142
 QS143
 QS144
 QS145
 QS146
 QS147
 QS148
 QS149
 QS150
 QS151
 QS152
 QS153
 QS154
 QS155
 QS156
 QS157
 QS158
 QS159
 QS160
 QS161
 QS162
 QS163
 QS164
 QS165
 QS166
 QS167
 QS168
 QS169
 QS170
 QS171
 QS172
 QS173
 QS174
 QS175
 QS176
 QS177
 QS178
 QS179
 QS180
 QS181
 QS182
 QS183
 QS184
 QS185
 QS186
 QS187
 QS188
 QS189
 QS190
 QS191
 QS192
 QS193
 QS194
 QS195
 QS196
 QS197
 QS198
 QS199
 QS200
 QS201
 QS202
 QS203
 QS204
 QS205
 QS206
 QS207
 QS208
 QS209
 QS210
 QS211
 QS212
 QS213
 QS214
 QS215
 QS216
 QS217
 QS218
 QS219
 QS220
 QS221
 QS222
 QS223
 QS224
 QS225
 QS226
 QS227
 QS228
 QS229
 QS230
 QS231
 QS232
 QS233
 QS234
 QS235
 QS236
 QS237
 QS238
 QS239
 QS240
 QS241
 QS242
 QS243
 QS244
 QS245
 QS246
 QS247
 QS248
 QS249
 QS250
 QS251
 QS252
 QS253
 QS254
 QS255
 QS256
 QS257
 QS258
 QS259
 QS260
 QS261
 QS262
 QS263
 QS264
 QS265
 QS266
 QS267
 QS268
 QS269
 QS270
 QS271
 QS272
 QS273
 QS274
 QS275
 QS276
 QS277
 QS278
 QS279
 QS280
 QS281
 QS282
 QS283
 QS284
 QS285
 QS286
 QS287
 QS288
 QS289
 QS290
 QS291
 QS292
 QS293
 QS294
 QS295
 QS296
 QS297
 QS298
 QS299
 QS300
 QS301
 QS302
 QS303
 QS304
 QS305
 QS306
 QS307
 QS308
 QS309
 QS310
 QS311
 QS312
 QS313
 QS314
 QS315
 QS316
 QS317
 QS318
 QS319
 QS320
 QS321
 QS322
 QS323
 QS324
 QS325
 QS326
 QS327
 QS328
 QS329
 QS330
 QS331
 QS332
 QS333
 QS334
 QS335
 QS336
 QS337
 QS338
 QS339
 QS340
 QS341
 QS342
 QS343
 QS344
 QS345
 QS346
 QS347
 QS348
 QS349
 QS350
 QS351
 QS352
 QS353
 QS354
 QS355
 QS356
 QS357
 QS358
 QS359
 QS360
 QS361
 QS362
 QS363
 QS364
 QS365
 QS366
 QS367
 QS368
 QS369
 QS370
 QS371
 QS372
 QS373
 QS374
 QS375
 QS376
 QS377
 QS378
 QS379
 QS380
 QS381
 QS382
 QS383
 QS384
 QS385
 QS386
 QS387
 QS388
 QS389
 QS390
 QS391
 QS392
 QS393
 QS394
 QS395
 QS396
 QS397
 QS398
 QS399
 QS400
 QS401
 QS402
 QS403
 QS404
 QS405
 QS406
 QS407
 QS408
 QS409
 QS410
 QS411
 QS412
 QS413
 QS414
 QS415
 QS416
 QS417
 QS418
 QS419
 QS420
 QS421
 QS422
 QS423
 QS424
 QS425
 QS426
 QS427
 QS428
 QS429
 QS430
 QS431
 QS432
 QS433
 QS434
 QS435
 QS436
 QS437
 QS438
 QS439
 QS440
 QS441
 QS442
 QS443
 QS444
 QS445
 QS446
 QS447
 QS448
 QS449
 QS450
 QS451
 QS452
 QS453
 QS454
 QS455
 QS456
 QS457
 QS458
 QS459
 QS460
 QS461
 QS462
 QS463
 QS464
 QS465
 QS466
 QS467
 QS468
 QS469
 QS470
 QS471
 QS472
 QS473
 QS474
 QS475
 QS476
 QS477
 QS478
 QS479
 QS480
 QS481
 QS482
 QS483
 QS484
 QS485
 QS486
 QS487
 QS488
 QS489
 QS490
 QS491
 QS492
 QS493
 QS494
 QS495
 QS496
 QS497
 QS498
 QS499
 QS500
 QS501
 QS502
 QS503
 QS504
 QS505
 QS506
 QS507
 QS508
 QS509
 QS510
 QS511
 QS512
 QS513
 QS514
 QS515
 QS516
 QS517
 QS518
 QS519
 QS520
 QS521
 QS522
 QS523
 QS524
 QS525
 QS526
 QS527
 QS528
 QS529
 QS530
 QS531
 QS532
 QS533
 QS534
 QS535
 QS536
 QS537
 QS538
 QS539
 QS540
 QS541
 QS542
 QS543
 QS544
 QS545
 QS546
 QS547
 QS548
 QS549
 QS550
 QS551
 QS552
 QS553
 QS554
 QS555
 QS556
 QS557
 QS558
 QS559
 QS560
 QS561
 QS562
 QS563
 QS564
 QS565
 QS566
 QS567
 QS568
 QS569
 QS570
 QS571
 QS572
 QS573
 QS574
 QS575
 QS576
 QS577
 QS578
 QS579
 QS580
 QS581
 QS582
 QS583
 QS584
 QS585
 QS586
 QS587
 QS588
 QS589
 QS590
 QS591
 QS592
 QS593
 QS594
 QS595
 QS596
 QS597
 QS598
 QS599
 QS600
 QS601
 QS602
 QS603
 QS604
 QS605
 QS606
 QS607
 QS608
 QS609
 QS610
 QS611
 QS612
 QS613
 QS614
 QS615
 QS616
 QS617
 QS618
 QS619
 QS620
 QS621
 QS622
 QS623
 QS624
 QS625
 QS626
 QS627
 QS628
 QS629
 QS630
 QS631
 QS632
 QS633
 QS634
 QS635
 QS636
 QS637
 QS638
 QS639
 QS640
 QS641
 QS642
 QS643
 QS644
 QS645
 QS646
 QS647
 QS648
 QS649
 QS650
 QS651
 QS652
 QS653
 QS654
 QS655
 QS656
 QS657
 QS658
 QS659
 QS660
 QS661
 QS662
 QS663
 QS664
 QS665
 QS666
 QS667
 QS668
 QS669
 QS670
 QS671
 QS672
 QS673
 QS674
 QS675
 QS676
 QS677
 QS678
 QS679
 QS680
 QS681
 QS682
 QS683
 QS684
 QS685
 QS686
 QS687
 QS688
 QS689
 QS690
 QS691
 QS692
 QS693
 QS694
 QS695
 QS696
 QS697
 QS698
 QS699
 QS700
 QS701
 QS702
 QS703
 QS704
 QS705
 QS706
 QS707
 QS708
 QS709
 QS710
 QS711
 QS712
 QS713
 QS714
 QS715
 QS716
 QS717
 QS718
 QS719
 QS720
 QS721
 QS722
 QS723
 QS724
 QS725
 QS726
 QS727
 QS728
 QS729
 QS730
 QS731
 QS732
 QS733
 QS734
 QS735
 QS736
 QS737
 QS738
 QS739
 QS740
 QS741
 QS742
 QS743
 QS744
 QS745
 QS746
 QS747
 QS748
 QS749
 QS750
 QS751
 QS752
 QS753
 QS754
 QS755
 QS756
 QS757
 QS758
 QS759
 QS760
 QS761
 QS762
 QS763
 QS764
 QS765
 QS766
 QS767
 QS768
 QS769
 QS770
 QS771
 QS772
 QS773
 QS774
 QS775
 QS776
 QS777
 QS778
 QS779
 QS780
 QS781
 QS782
 QS783
 QS784
 QS785
 QS786
 QS787
 QS788
 QS789
 QS790
 QS791
 QS792
 QS793
 QS794
 QS795
 QS796
 QS797
 QS798
 QS799
 QS800
 QS801
 QS802
 QS803
 QS804
 QS805
 QS806
 QS807
 QS808
 QS809
 QS810
 QS811
 QS812
 QS813
 QS814
 QS815
 QS816
 QS817
 QS818
 QS819
 QS820
 QS821
 QS822
 QS823
 QS824
 QS825
 QS826
 QS827
 QS828
 QS829
 QS830
 QS831
 QS832
 QS833
 QS834
 QS835
 QS836
 QS837
 QS838
 QS839
 QS840
 QS841
 QS842
 QS843
 QS844
 QS845
 QS846
 QS847
 QS848
 QS849
 QS850
 QS851
 QS852
 QS853
 QS854
 QS855
 QS856
 QS857
 QS858
 QS859
 QS860
 QS861
 QS862
 QS863
 QS864
 QS865
 QS866
 QS867
 QS868
 QS869
 QS870
 QS871
 QS872
 QS873
 QS874
 QS875
 QS876
 QS877
 QS878
 QS879
 QS880
 QS881
 QS882
 QS883
 QS884
 QS885
 QS886
 QS887
 QS888
 QS889
 QS890
 QS891
 QS892
 QS893
 QS894
 QS895
 QS896
 QS897
 QS898
 QS899
 QS900
 QS901
 QS902
 QS903
 QS904
 QS905
 QS906
 QS907
 QS908
 QS909
 QS910
 QS911
 QS912
 QS913
 QS914
 QS915
 QS916
 QS917
 QS918
 QS919
 QS920
 QS921
 QS922
 QS923
 QS924
 QS925
 QS926
 QS927
 QS928
 QS929
 QS930
 QS931
 QS932
 QS933
 QS934
 QS935
 QS936
 QS937
 QS938
 QS939
 QS940
 QS941
 QS942
 QS943
 QS944
 QS945
 QS946
 QS947
 QS948
 QS949
 QS950
 QS951
 QS952
 QS953
 QS954
 QS955
 QS956
 QS957
 QS958
 QS959
 QS960
 QS961
 QS962
 QS963
 QS964
 QS965
 QS966
 QS967
 QS968
 QS969
 QS970
 QS971
 QS972
 QS973
 QS974
 QS975
 QS976
 QS977
 QS978
 QS979
 QS980
 QS981
 QS982
 QS983
 QS984
 QS985
 QS986
 QS987
 QS988
 QS989
 QS990
 QS991
 QS992
 QS993
 QS994
 QS995
 QS996
 QS997
 QS998
 QS999
 QS1000

Advantages at a glance

- Minimum power loss due to integrated bypass contacts after successful startup
- No additional heat generation
- Low maintenance costs
- Compact design and low capital investment costs compared with frequency converters
- Substantial space savings in the control panel compared with a contactor assembly for star-delta (wye-delta) starting

4

Simply the cleverer choice for many applications







There is no general answer to whether a soft starter or frequency converter is the optimum solution. The decisive factors are the application itself and its specific boundary conditions such as mechanical load, cost efficiency, compliance with standards, reliability, energy efficiency balance, etc.

Added value due to soft starter

While, for applications with variable speeds, the use of a frequency converter is recommended, soft starters are always the first choice when the application does not require variable speed.

In this case, as a low-cost and low-maintenance drive solution that does not need extensive accessories, soft starters offer a whole range of advantages:

Advantages of a soft starter at a glance

 <p>Lower capital investment costs</p>	 <p>Space savings thanks to compact design</p>	 <p>Low maintenance costs</p>
 <p>No additional heat generation</p>	 <p>Easy to wire</p>	 <p>Reduced energy losses during operation due to bypass contacts</p>
 <p>EMC-optimized for less interference from unwanted electrical or electromagnetic effects</p>		

Selection of the right 3RW soft starter – engineering made easy

Specifying motor and load data results in the correct soft starter. For easy selection of the correctly dimensioned soft starter, two selection tools are available free of charge:

STS = Simulation Tool for Soft Starters as an application-specific selection guide;
www.siemens.com/sts

TST = TIA Selection Tool as a configurator;
www.siemens.com/tstcloud

More information on these tools is available in Siemens Industry Online Support at www.siemens.com/sios (keywords STS and TIA Selection Tool).

Digital product data for all common engineering tools make engineering simple.

SIRIUS 3RW30

The SIRIUS 3RW30 soft starter for easy starting conditions

- Two-phase controlled
- Motors up to 55 kW at 400 V (max. 600 V AC)
- No smooth ramp-down (except 3RW3003)
- Very compact for space saving in the control panel
- Optimum adaptation to the drive task by individual potentiometers for starting voltage (40 ... 100%), startup time up to 20 s
- Modern hybrid switching technology

SIRIUS 3RW30 soft starters

Rated operational voltage U_e	Rated operational current I_e at 40 °C	Rated power of three-phase motors at rated operational voltage U_e		Size	Article No.	
		V	A			kW at 230 V
Soft starters for easy starting and runout conditions and high switching frequency						
200 ... 400	3		0.55	1.1	22.5 mm	3RW3003-□ CB5 4
Soft starters for three-phase asynchronous motors (without smooth ramp-down)						
200 ... 480	3.6		0.75	1.5	S00	3RW3013-□ BB□ 4
 Size S0	6.5		1.5	3	S00	3RW3014-□ BB□ 4
	9		2.2	4	S00	3RW3016-□ BB□ 4
	12.5		3	5.5	S00	3RW3017-□ BB□ 4
	17.6		4	7.5	S00	3RW3018-□ BB□ 4
	25		5.5	11	S0	3RW3026-□ BB□ 4
	32		7.5	15	S0	3RW3027-□ BB□ 4
	38		11	18.5	S0	3RW3028-□ BB□ 4
	45		11	22	S2	3RW3036-□ BB□ 4
	63		18.5	30	S2	3RW3037-□ BB□ 4
	72		22	37	S2	3RW3038-□ BB□ 4
	80		22	45	S3	3RW3046-□ BB□ 4
	106		30	55	S3	3RW3047-□ BB□ 4

□ = Article No. supplement for connection types:

□ = Article No. supplement for rated control supply voltage U_c :

* Main connection from size S2: Screw terminals

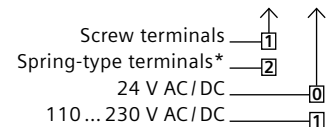

Dimensions W x H x D in mm		3RW300.	3RW301.	3RW302.	3RW303.	3RW304.
Screw terminals		22.5 x 100 x 120	45 x 95 x 151	45 x 125 x 151	55 x 144 x 168	70 x 160 x 186
Spring-type terminals		22.5 x 102 x 120	45 x 117 x 151	45 x 150 x 151	55 x 144 x 168	70 x 160 x 186

The 3RW soft starters should always be designed on the basis of the required rated operational current of the motor. The motor ratings listed in the selection and ordering data are rough guide values and designed for normal starting conditions (CLASS 10). For other starting conditions we recommend the Simulation Tool for Soft Starters (STS).

SIRIUS 3RW40

The SIRIUS 3RW40 soft starter for simple starting **and** stopping conditions (not only soft starting but also soft stopping 0 ... 20 s and settable current limitation)

- Two-phase controlled
- Motors up to 55 kW at 400 V (max. 600 V AC)
- Integrated intrinsic device protection prevents overload of the device
- Perfect protection due to integrated motor overload protection (Class 10, 15, 20) and optional thermistor motor protection (see footer), manual and remote reset as standard
- Modern hybrid switching technology

SIRIUS 3RW40 soft starters, Class 10

Rated operational voltage U_e	Rated operational current I_e at 40 °C	Rated power of three-phase motors at rated operational voltage U_e		Size	Article No.	
		V	A			kW at 230 V
	200 ... 480	12.5	3	5.5	S0	3RW4024-□ BB□4
	25	5.5	11	S0	3RW4026-□ BB□4	
	32	7.5	15	S0	3RW4027-□ BB□4	
	38	11	18.5	S0	3RW4028-□ BB□4	
	45	11	22	S2	3RW4036-□ BB□4	
	63	18.5	30	S2	3RW4037-□ BB□4	
	72	22	37	S2	3RW4038-□ BB□4	
	80	22	45	S3	3RW4046-□ BB□4	
	106	30	55	S3	3RW4047-□ BB□4	

□ = Article No. supplement for connection types:

□ = Article No. supplement for rated control supply voltage U_s :

* Main connection from size S2: Screw terminals

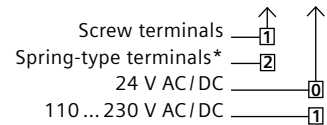

Dimensions W x H x D in mm		3RW402.	3RW403.	3RW404.
Screw terminals		45 x 125 x 154	55 x 144 x 170	70 x 160 x 188
Spring-type terminals		45 x 150 x 154	55 x 144 x 170	70 x 160 x 188



The following versions can also be supplied:

- For rated operational voltage 400 ... 600 V
- Sizes S0 to S3 with integrated thermistor motor protection (for motor with ThermoClick sensor or PTC type A) with rated control supply voltage U_s 24 V AC/DC

The 3RW soft starters should always be designed on the basis of the required rated operational current of the motor. The motor ratings listed in the selection and ordering data are rough guide values and designed for normal starting conditions (CLASS 10). For other starting conditions we recommend the Simulation Tool for Soft Starters (STS).

Optional accessories for SIRIUS 3RW30 and 3RW40

Optional accessories for 3RW30 and 3RW40 soft starters

Link module soft starter to motor starter protector*	Soft starter		Motor starter protector	Article No.
	Type	Size	Size	
	With screw terminals			
	3RW301.	S00	S00	3RA2921-1BA00
	3RW302.	S0	S00/S0	3RA2921-1BA00
	3RW402.			
	3RW3036.	S2	S2	3RA2931-1AA00
	3RW4036.			
	3RW3046.	S3	S3	3RA1941-1AA00
	3RW3047.			
	3RW4046.			
3RW4047.				
With spring-type terminals				
	3RW301.	S00	S00	3RA2911-2GA00
	3RW302.	S0	S0	3RA2921-2GA00
	3RW402.			

* Can be used in size S0 up to 32 A
 In size S2 up to 65 A with DIN rail adapter for soft starter (article no.: 3RA2932-1CA00)
 Can be used in size S3 with mounting plate only

Optional accessories for the 3RW40 soft starter

Fan*	Soft starter		Article No.
	Type	Size	
	3RW402.	S0	3RW4928-8VB00
	3RW403.	S2	3RW4947-8VB00
	3RW404.	S3	

* To increase switching frequency and for device mounting in positions different to the standard position

Optional/included accessories for the SIRIUS 3RW50, 3RW52 and 3RW55 soft starters



Version	Soft starter	Optional/inclusive	Article No.	
Hinged cover				
Without cutout	3RW52	- / X	3RW5950-0GL20	
	3RW55	X / -		
With cutout for HMI Standard	3RW52	X / -	3RW5950-0GL40	
	3RW55	- / -		
With cutout for HMI High Feature	3RW52	X / -	3RW5950-0GL30	
	3RW55	- / X		
HMI modules				
Standard	3RW50	X / -	3RW5980-0HS00	
	3RW52	X / -		
	3RW55	- / -		
High Feature	3RW50	X / -	3RW5980-0HF00	
	3RW52	X / -		
	3RW55	- / X		
Connecting cable for door mounting				
5.0 m, round	3RW50/52/55	Accessories required for door mounting; length can be selected as required	3RW5980-0HC60	
2.5 m, round	3RW50/52/55		3UF7933-0BA00-0	
1.0 m, round	3RW50/52/55		3UF7937-0BA00-0	
0.5 m, round	3RW50/52/55		3UF7932-0BA00-0	
Connecting cable for installation in the device				
0.1 m, flat	3RW52	Accessories required for installation in the device	3UF7931-0AA00-0	
Communication modules				
PROFINET High Feature with integrated switch	3RW55	X / -	3RW5950-0CH00	
PROFINET Standard	3RW50/52/55	X / -	3RW5980-0CS00	
PROFIBUS	3RW50/52/55	X / -	3RW5980-0CP00	
EtherNet/IP	3RW50/52/55	X / -	3RW5980-0CE00	
Modbus RTU	3RW50/52/55	X / -	3RW5980-0CR00	
Modbus TCP	3RW50/52/55	X / -	3RW5980-0CT00	
COM connecting cable for mounting laterally on the device, 0.3 m	3RW50	Accessories required for lateral mounting	3RW5900-0CC00	
Fan covers				
	Required quantity	Soft starter	Optional	Article No.
	1x	3RW50	X	3RW5985-0FC00
	1x	3RW5216/5217	X	3RW5983-0FC00
		3RW551	X	
	2x	3RW5226/5227	X	3RW5983-0FC00
		3RW523	X	
		3RW552/553	X	
	1x	3RW524	X	3RW5984-0FC00
3RW554		X		

SIRIUS 3RW50

The SIRIUS 3RW50 soft starter as a compact solution for standard applications

- 2-phase controlled
- For drives from 75 to 315 kW at 400V (max. 600 V AC)
- Soft starting and smooth ramp-down
- Current limitation and motor overload protection
- Optional HMI modules and communication modules (external connection)
- Optional analog output or thermistor motor protection
- Modern hybrid switching technology
- Small, compact design
- Parameter assignment by means of potentiometers
- Optional TIA integration

Soft starter as a compact solution for standard applications SIRIUS 3RW50, CLASS 10E, operating voltage 200 ... 480V

Rated voltage U_e	Rated current I_e at 40 °C	Rated power of three-phase motors at rated voltage U_e		Size	Article No.
		kW at 230 V	kW at 400 V		
200 ... 480	143	37	75	S6	3RW5055-□□B□ 4
	171	45	90	S6	3RW5056-□□B□ 4
	210	55	110	S12	3RW5072-□□B□ 4
	250	75	132	S12	3RW5073-□□B□ 4
	315	90	160	S12	3RW5074-□□B□ 4
	370	110	200	S12	3RW5075-□□B□ 4
	470	132	250	S12	3RW5076-□□B□ 4
	570	160	315	S12	3RW5077-□□B□ 4

Electrical connection type for control circuit:

Product function:

Control supply voltage:

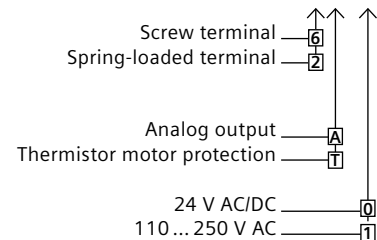

Mounting dimensions W x H x D in mm		3RW5055 / 3RW5056	3RW5072 / 3RW5073 / 3RW5074 / 3RW5075 / 3RW5076 / 3RW5077
		Screw mounting	120 x 198 x 249

The following versions are also available:
 • for rated operational voltage 200 ... 600 V

The 3RW soft starters should always be designed on the basis of the required rated operational current of the motor. The motor ratings listed in the selection and ordering data are rough guide values and designed for basic starting conditions (CLASS 10). For other starting conditions we recommend the Simulation Tool for Soft Starters (STS).

SIRIUS 3RW52

The SIRIUS 3RW52 soft starter as an ideal solution for normal starting and stopping

- Three-phase controlled
- For drives from 5.5 to 560 kW at 400 V (maximum 600 V AC)
- Soft starting and smooth ramp-down
- Current limiting and motor overload protection
- Soft Torque (optimizes the acceleration shortly before the rated speed is reached and ensures a constant decrease in speed for a smooth ramp-down and thus an improved pump stopping mode)
- Optional HMI modules
- Plug-in communication modules (PROFINET, PROFIBUS; EtherNet/IP, Modbus)
- Optional software for optimum integration in the TIA Portal
- Modern hybrid switching technology

SIRIUS 3RW52 soft starters for standard applications, Class 10A, operational voltage 200 ... 480 V

Rated current at 40°C in A		Rated power for three-phase motors		Size	Article No.	
Standard	$\sqrt{3}$	kW at 230 V	kW at 400 V		Inline circuit	Inside-delta circuit*
13	–	3	5.5	Size 1	3RW5213-□□C□ 4	–
18	–	4	7.5	Size 1	3RW5214-□□C□ 4	3RW5213-□□C□ 4
25	22.5	5.5	11	Size 1	3RW5215-□□C□ 4	3RW5213-□□C□ 4
32	31.5	7.5	15	Size 1	3RW5216-□□C□ 4	3RW5214-□□C□ 4
38	43.3	11	18.5	Size 1	3RW5217-□□C□ 4	3RW5215-□□C□ 4
47	55.4	11/15 ($\sqrt{3}$)	22	Size 2/Size 1 ($\sqrt{3}$)	3RW5224-□□C□ 4	3RW5216-□□C□ 4
63	65.8	18.5	30	Size 2/Size 1 ($\sqrt{3}$)	3RW5225-□□C□ 4	3RW5217-□□C□ 4
77	–	22	37	Size 2	3RW5226-□□C□ 4	3RW5224-□□C□ 4
93	81.4	22	45	Size 2	3RW5227-□□C□ 4	3RW5224-□□C□ 4
113	109	30	55	Size 3/Size 2 ($\sqrt{3}$)	3RW5234-□□C□ 4	3RW5225-□□C□ 4
143	133	37	75	Size 3/Size 2 ($\sqrt{3}$)	3RW5235-□□C□ 4	3RW5226-□□C□ 4
171	161	45	90	Size 3/Size 2 ($\sqrt{3}$)	3RW5236-□□C□ 4	3RW5227-□□C□ 4
210	196	55	110	Size 4/Size 3 ($\sqrt{3}$)	3RW5243-□□C□ 4	3RW5234-□□C□ 4
250	248	75	132	Size 4/Size 3 ($\sqrt{3}$)	3RW5244-□□C□ 4	3RW5235-□□C□ 4
315	296	90	160	Size 4/Size 3 ($\sqrt{3}$)	3RW5245-□□C□ 4	3RW5236-□□C□ 4
370	364	110	200	Size 4	3RW5246-□□C□ 4	3RW5243-□□C□ 4
470	433	132	250	Size 4	3RW5247-□□C□ 4	3RW5244-□□C□ 4
570	546	160	315	Size 4	3RW5248-□□C□ 4	3RW5245-□□C□ 4
–	641	200	355	Size 4	–	3RW5246-□□C□ 4
–	814	250	400	Size 4	–	3RW5247-□□C□ 4
–	987	315	560	Size 4	–	3RW5248-□□C□ 4

Electrical connection type for control circuit:

Product function:

Control supply voltage:

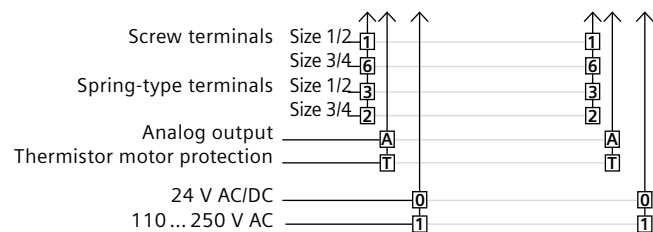

Dimensions W x H x D in mm		3RW521.	3RW522., 3RW523.	3RW524.
Screw fixing		170 x 275 x 152	185 x 306 x 203	210 x 393 x 203

The following versions are also available: for rated operational voltage 200 ... 600 V

The 3RW soft starters should always be designed on the basis of the required rated operational current of the motor. The motor ratings listed in the selection and ordering data are rough guide values and designed for normal starting conditions (CLASS 10). For other starting conditions we recommend the Simulation Tool for Soft Starters (STS).

SIRIUS 3RW55

The SIRIUS 3RW55 soft starter as a perfect solution for difficult starting and stopping operations

- Three-phase controlled
- For drives from 5.5 to 1200 kW at 400 V (can be used in supply systems up to 690 V)
- Soft starting and stopping
- Current limiting and motor overload protection
- Pump stop and torque control
- Plug-in communication modules (PROFINET, PROFIBUS; Modbus)
- Automatic parameterization
- Removable HMI module with color display and slot for micro SD memory card
- Optional integration into the TIA Portal
- Modern hybrid industrial controls
- also available as failsafe version

Soft starter for difficult starting and stopping, SIRIUS 3RW55, Class 10E, operational voltage 200 ... 480 V

Rated current at 40°C in A		Rated power for three-phase motors		Size	Article No.	Article No.
Standard	$\sqrt{3}$	kW at 230 V	kW at 400 V		Inline circuit	Inside-delta circuit*
13	–	3	5.5	Size 1	3RW5513-□ HA□ 4	–
18	–	4	7.5	Size 1	3RW5514-□ HA□ 4	3RW5513-□ HA□ 4
25	22.5	5.5	11	Size 1	3RW5515-□ HA□ 4	3RW5513-□ HA□ 4
32	31.5	7.5	15	Size 1	3RW5516-□ HA□ 4	3RW5514-□ HA□ 4
38	43.3	11	18.5	Size 1	3RW5517-□ HA□ 4	3RW5515-□ HA□ 4
47	55.4	11/15 ($\sqrt{3}$)	22	Size 2/Size 1 ($\sqrt{3}$)	3RW5524-□ HA□ 4	3RW5516-□ HA□ 4
63	65.8	18.5	30	Size 2/Size 1 ($\sqrt{3}$)	3RW5525-□ HA□ 4	3RW5517-□ HA□ 4
77	–	22	37	Size 2	3RW5526-□ HA□ 4	3RW5524-□ HA□ 4
93	81.4	22	45	Size 2	3RW5527-□ HA□ 4	3RW5524-□ HA□ 4
113	109	30	55	Size 3/Size 2 ($\sqrt{3}$)	3RW5534-□ HA□ 4	3RW5525-□ HA□ 4
143	133	37	75	Size 3/Size 2 ($\sqrt{3}$)	3RW5535-□ HA□ 4	3RW5526-□ HA□ 4
171	161	45	90	Size 3/Size 2 ($\sqrt{3}$)	3RW5536-□ HA□ 4	3RW5527-□ HA□ 4
210	196	55	110	Size 4/Size 3 ($\sqrt{3}$)	3RW5543-□ HA□ 4	3RW5534-□ HA□ 4
250	248	75	132	Size 4/Size 3 ($\sqrt{3}$)	3RW5544-□ HA□ 4	3RW5535-□ HA□ 4
315	296	90	160	Size 4/Size 3 ($\sqrt{3}$)	3RW5545-□ HA□ 4	3RW5536-□ HA□ 4
370	364	110	200	Size 4	3RW5546-□ HA□ 4	3RW5543-□ HA□ 4
470	433	132	250	Size 4	3RW5547-□ HA□ 4	3RW5544-□ HA□ 4
570	546	160	315	Size 4	3RW5548-□ HA□ 4	3RW5545-□ HA□ 4
–	641	200	355	Size 4	–	3RW5546-□ HA□ 4
–	814	250	400	Size 4	–	3RW5547-□ HA□ 4
–	987	315	560	Size 4	–	3RW5548-□ HA□ 4

Electrical connection type for control circuit:

Control supply voltage:

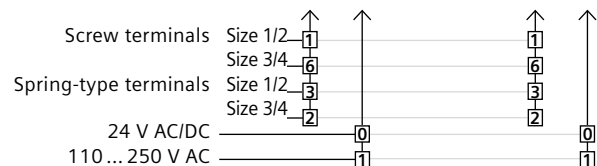

Dimensions W x H x D in mm		3RW551.	3RW552., 3RW553.	3RW554.
Screw fixing		170 x 275 x 152	185 x 306 x 203	210 x 393 x 203

Devices with higher output in size 5 and the following versions are also available: for rated operational voltage 200 ... 600 V (3RW551) and 200 ... 690 V (3RW552, 3RW553 and 3RW554). The 3RW soft starters should always be designed on the basis of the required rated operational current of the motor. The motor ratings listed in the selection and ordering data are rough guide values and designed for normal starting conditions (CLASS 10). For other starting conditions we recommend the Simulation Tool for Soft Starters (STS).

SIRIUS 3RW55 Failsafe

The SIRIUS 3RW55 Failsafe soft starter with an integrated fail-safe digital input as a perfect solution for difficult starting and ramp-down procedures

Integrated Safe Torque Off function (STO)

- 3-phase controlled
- For drives from 5.5 to 560 kW
- Soft starting and smooth ramp-down
- Fail-safe disconnection up to SIL3, PL e / STO
- Pump stop and torque control
- Plug-in communication modules (PROFINET, PROFIBUS; EtherNet/IP, Modbus)
- Automatic parameter assignment
- Removable HMI module with color display and slot for micro SD memory card
- Optional TIA Portal integration
- Modern hybrid industrial controls

Soft starter with integrated fail-safe digital input SIRIUS 3RW55 Failsafe, Class 10E, operating voltage 200...480 V

Rated current at 40 °C in A		Rated power for three-phase motors		Size	Article No.	
Standard	$\sqrt{3}$	kW at 230 V	kW at 400 V		Standard circuit	Inside-delta circuit
13	-	3	5.5	Size 1	3RW5513-□ HF□ 4	-
18	-	4	7.5	Size 1	3RW5514-□ HF□ 4	-
25	22.5	5.5	11	Size 1	3RW5515-□ HF□ 4	3RW5513-□ HF□ 4
32	31.5	7.5	15	Size 1	3RW5516-□ HF□ 4	3RW5514-□ HF□ 4
38	43.3	11	18.5	Size 1	3RW5517-□ HF□ 4	3RW5515-□ HF□ 4
47	55.4	11/15 ($\sqrt{3}$)	22	Size 2/Size 1 ($\sqrt{3}$)	3RW5524-□ HF□ 4	3RW5516-□ HF□ 4
63	65.8	18.5	30	Size 2/Size 1 ($\sqrt{3}$)	3RW5525-□ HF□ 4	3RW5517-□ HF□ 4
77	-	22	37	Size 2	3RW5526-□ HF□ 4	-
93	81.4	22	45	Size 2	3RW5527-□ HF□ 4	3RW5524-□ HF□ 4
113	109	30	55	Size 3/Size 2 ($\sqrt{3}$)	3RW5534-□ HF□ 4	3RW5525-□ HF□ 4
143	133	37	75	Size 3/Size 2 ($\sqrt{3}$)	3RW5535-□ HF□ 4	3RW5526-□ HF□ 4
171	161	45	90	Size 3/Size 2 ($\sqrt{3}$)	3RW5536-□ HF□ 4	3RW5527-□ HF□ 4
210	196	55	110	Size 4/Size 3 ($\sqrt{3}$)	3RW5543-□ HF□ 4	3RW5534-□ HF□ 4
250	248	75	132	Size 4/Size 3 ($\sqrt{3}$)	3RW5544-□ HF□ 4	3RW5535-□ HF□ 4
315	296	90	160	Size 4/Size 3 ($\sqrt{3}$)	3RW5545-□ HF□ 4	3RW5536-□ HF□ 4
370	364	110	200	Size 4	3RW5546-□ HF□ 4	3RW5543-□ HF□ 4
470	433	132	250	Size 4	3RW5547-□ HF□ 4	3RW5544-□ HF□ 4
570	546	160	315	Size 4	3RW5548-□ HF□ 4	3RW5545-□ HF□ 4
-	641	200	355	Size 4	-	3RW5546-□ HF□ 4
-	814	250	400	Size 4	-	3RW5547-□ HF□ 4
-	987	315	560	Size 4	-	3RW5548-□ HF□ 4

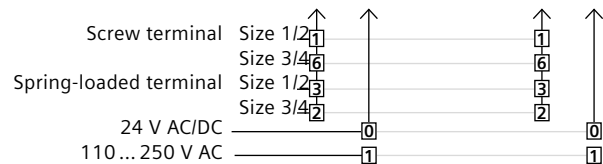

Mounting dimensions WxHxD in mm		3RW551.	3RW552., 3RW553.	3RW554.
Screw mounting		170 x 275 x 152	185 x 306 x 203	210 x 393 x 203

The 3RW soft starters should always be designed on the basis of the required rated operational current of the motor. The motor ratings listed in the selection and ordering data are rough guide values and designed for basic starting conditions (CLASS 10). For other starting conditions we recommend the Simulation Tool for Soft Starters (STS).

Soft starter instead of star-delta

Less is more when it comes to benefits

Star-delta combinations (also known as wye-delta starters) are a traditional solution for preventing unpleasant side effects when starting motors, such as voltage dips in the grid and strong transient torques in the mechanical system. Modern hybrid switching solutions can also master these challenges as well as provide additional functionality, resulting in additional advantages.

- Use modern hybrid industrial controls for less wear of the switching contacts, because the starting current is first engaged via the electronic contact elements (Thyristor, Triac) and the mechanical contact elements are only engaged when the rated speed is reached
- More functions than star-delta (wye-delta) circuits: soft and reduced-current starting, soft ramp-down, etc.
- Only one device and thus, significantly less wiring and ordering costs and efforts; less space required
- Considerably more flexible and more powerful, because of the precise setting options for the starting conditions

Use of a SIRIUS 3RW52 and 3RW55 soft starter in standard or inside-delta circuit

When considering replacing a star-delta (wye-delta) combination with a soft starter, the question of whether to use standard wiring or inside-delta wiring automatically arises. Therefore, when selecting a 3-phase controlled soft starter, the two options of standard circuit or inside-delta circuit should always be checked (see selection tables on previous pages).

With an inside-delta circuit, the motor current which flows through the soft starter is reduced by the factor of $\sqrt{3}$, therefore a smaller soft starter can be

selected. This reduces costs and the wiring setup can be used almost unchanged.

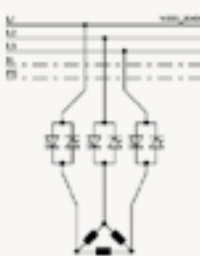
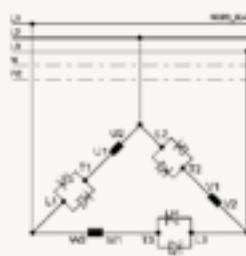
	<p>Inline circuit</p> <ul style="list-style-type: none"> • Easier wiring (3 wires) • Compared with an inside-delta circuit, a larger soft starter must be selected 		<p>Inside-delta circuit</p> <ul style="list-style-type: none"> • More complicated wiring (6 wires, smaller conductor cross-section can be used than for an inline circuit) • Star-delta (wye-delta) easily replaceable by inside-delta soft starter solution thanks to existing wiring • Selection of a smaller soft starter at a lower price is possible because the motor current flowing through the soft starter is reduced by a factor of $\sqrt{3}$
---	---	--	--

3RM1 and ET 200SP motor starters

For starting one or more motors, the local conditions and the requirements of the application are very different. For that reason, Siemens offers other solutions to start motors using modern hybrid industrial controls, with all the advantages associated: 3RM1 motor starters, when space is at a premium, or ET 200SP motor starters for active communication with the controller, despite confined space.



You choose which solution is the most suitable.



Both starters can be ordered as direct-on-line starters and reversing starters.



You decide between spring-type or screw terminals.



Even safety applications are no problem because both starters are also available as a failsafe version.

3RM1 motor starters

If every millimeter in the control panel counts, the 3RM1 motor starters with hybrid switching technology are the perfect solution for starting motors up to 3 kW (at 400 V).



- In a width of only 22.5 mm
- Relay contacts, power semiconductors and electronic overload relays (overload protection) in one device
- Available as direct-on-line and reversing starters
- Versions with safety-related shutdown up to SIL3/PL e
- Three-phase infeed system for easy, time-saving and safe infeed of two or more motor starters
- Wide setting range for reduction of variants
- Group configurations in the smallest possible space
- Replaceable terminals (screw and spring-type connections)
- Modern hybrid switching technology

Motor starter as a direct-on-line or reversing starter, with/without failsafe, dimensions in mm (W x H x D) 22.5 x 100 x 141.6

Rating for three-phase motor at 400 V in kW	Setting range for electronic overload in A	Control supply voltage in V		Article No.	
		at DC	at 50/60 Hz AC	3RM1 direct-on-line starter	3RM1 reversing starter
0...0.12	0.1...0.5	24	–	3RM1001-□ AA04	3RM1201-□ AA04
0.09...0.75	0.4...2	24	–	3RM1002-□ AA04	3RM1202-□ AA04
0.55...3	1.6...7	24	–	3RM1007-□ AA04	3RM1207-□ AA04
0...0.12	0.1...0.5	110	110...230	3RM1001-□ AA14	3RM1201-□ AA14
0.09...0.75	0.4...2	110	110...230	3RM1002-□ AA14	3RM1202-□ AA14
0.55...3	1.6...7	110	110...230	3RM1007-□ AA14	3RM1207-□ AA14
Failsafe					
0...0.12	0.1...0.5	24	–	3RM1101-□ AA04	3RM1301-□ AA04
0.09...0.75	0.4...2	24	–	3RM1102-□ AA04	3RM1302-□ AA04
0.55...3	1.6...7	24	–	3RM1107-□ AA04	3RM1307-□ AA04
0...0.12	0.1...0.5	110	110...230	3RM1101-□ AA14	3RM1301-□ AA14
0.09...0.75	0.4...2	110	110...230	3RM1102-□ AA14	3RM1302-□ AA14
0.55...3	1.6...7	110	110...230	3RM1107-□ AA14	3RM1307-□ AA14

Type of electrical connection:

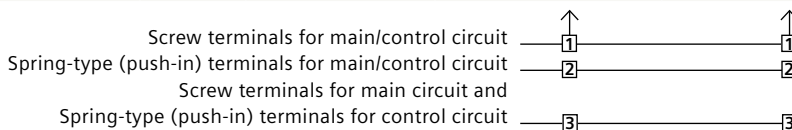

Optional accessories for the 3RM1 motor starter



Version	Article No.
Device connector for 3RM1, 24 V DC	3ZY1212-2EA00
Device terminating connector for 3RM1, 24 V DC	3ZY1212-2FA00
Three-phase infeed system for 3RM1 with screw terminals	
Three-phase infeed terminal	3RM1920-1AA
Three-phase busbar for 2 motor starters	3RM1910-1AA
Three-phase busbar for 3 motor starters	3RM1910-1BA
Three-phase busbar for 5 motor starters	3RM1910-1DA
Covers for 3 connection tags of the three-phase busbars	3RM1910-6AA

ET 200SP motor starters

The SIMATIC ET 200SP motor starter completes the distributed I/O system. With transmission of current values (energy management) and further analysis and diagnostics data (alarm status display), it offers a variety of options for plant monitoring and optimization.



- Only 30 mm module width
- Controlling, switching, starting and monitoring in the ET 200SP system
- Switching and protecting 1 and 3-phase loads up to 5.5 kW in five wide setting ranges
- Integrated short-circuit and overload protection
- Fast maintenance thanks to automatic parameter uploading
- Spring-loaded terminal (push-in)
- Toolless connection system
- One ordering unit always consists of a motor starter with a BaseUnit
- Connect main and supply voltage only once, i.e.: side-by-side modules are automatically connected
- Unplugging/plugging possible while system is energized and the ET 200SP station is running
- Modern hybrid switching technology

Motor Starter ET 200SP, dimensions in mm (W x H x D) 30 x 142 x 150

Max. current carrying capacity at startup in A	Setting range for electronic overload in A	Electronic overload protection at 400 V up to (kW)	Article No.	
			Direct-on-line starter	Reversing starters
4	0.1...0.4	0.09	3RK1308-0□ A00-OCPO	3RK1308-0□ A00-OCPO
10	0.3...1	0.25	3RK1308-0□ B00-OCPO	3RK1308-0□ B00-OCPO
30	0.9...3	1.1	3RK1308-0□ C00-OCPO	3RK1308-0□ C00-OCPO
90	2.8...9	4	3RK1308-0□ D00-OCPO	3RK1308-0□ D00-OCPO
100	4...12	5.5	3RK1308-0□ E00-OCPO	3RK1308-0□ E00-OCPO

Standard \uparrow A
Standard \uparrow B
Failsafe \downarrow C
Failsafe \downarrow D

BaseUnits, operating voltage rated value up to 500 V, dimensions in mm (W x H x D) 30 x 215 x 75

BaseUnits version ¹⁾	Operating voltage of the AC infeed in V	Supply voltage of the DC infeed in V	Article No.
With AC/DC infeed (standard)	500	24	3RK1908-0AP00-0APO
Without infeed (standard)	–	–	3RK1908-0AP00-0DPO
With AC infeed, with F-DI infeed (Failsafe)	500	–	3RK1908-0AP00-0GPO
Without AC/DC infeed, with F-DI forwarding (Failsafe)	–	–	3RK1908-0AP00-0JPO

¹⁾ The voltage is looped through from BaseUnits with infeed to downstream BaseUnits without infeed.

BaseUnits for empty modules upstream of the first motor starter (for interference-proof operation)

Version	Article No.
Light, opening a new potential group	6ES7193-6BP00-0DA0
Dark, looping through the potential group	6ES7193-6BP00-0BA0
Cover for empty modules, 15 mm	6ES7133-6CV15-1AM0

Optional accessories

Version	Article No.
Control Module 3DI/LC (push-in terminal, control supply voltage for DC rated value 20.4 ... 28.8 V), dimensions in mm (W x H x D) 30 x 54.5 x 42.3	3RK1908-1AA00-0BP0
Fans (already incl. at 12 A)	3RW4928-8VB00
Additional mechanical mounting, bag of 5 items	3RK1908-1EA00-1BP0

**Published by
Siemens AG**

Smart Infrastructure
Electrical Products
Werner-von-Siemens-Str. 48-50
92224 Amberg
Germany

**For the U.S. published by
Siemens Industry Inc.**

100 Technology Drive
Alpharetta, GA 30005
United States

Article No.: SIEP-B10001-00-7600
Dispo 18101 WS 04203.0
Printed in Germany
© Siemens 2020

Subject to changes and errors. The information given in this document only contains general descriptions and/or performance features which may not always specifically reflect those described, or which may undergo modification in the course of further development of the products. The requested performance features are binding only when they are expressly agreed upon in the concluded contract. Subject to change without prior notice.

All product designations may be trademarks or product names of Siemens AG or supplier companies whose use by third parties for their own purposes could violate the rights of the owners.

Security notes

Siemens provides products and solutions with industrial security functions that support the secure operation of plants, systems, machines and networks.

In order to protect plants, systems, machines and networks against cyber threats, it is necessary to implement – and continuously maintain – a holistic, state-of-the-art industrial security concept. Products and solutions from Siemens constitute one element of such a concept.

Customers are responsible for preventing unauthorized access to their plants, systems, machines and networks. Such systems, machines and components should only be connected to an enterprise network or the Internet if and to the extent such a connection is necessary and only when appropriate security measures (e.g. firewalls and/or network segmentation) are in place.

For additional information on industrial security measures that can be implemented, please visit:

<https://www.siemens.com/industrialsecurity>

Siemens' products and solutions undergo continuous development to make them more secure. Siemens strongly recommends that product updates are applied as soon as they become available, and that only the latest product versions are used. Use of product versions that are no longer supported, and failure to apply latest updates may increase customer's exposure to cyber threats.

To stay informed about product updates, subscribe to the Siemens Industrial Security RSS Feed under **<https://www.siemens.com/industrialsecurity>**.

3RW5553-2HA06	SIRIUS soft starter 200-690 V 720 A, 24 V AC/DC Spring-type terminals
3RW5553-2HA14	SIRIUS soft starter 200-480 V 720 A, 110-250 V AC Spring-type terminals
3RW5553-2HA16	SIRIUS soft starter 200-690 V 720 A, 110-250 V AC Spring-type terminals
3RW5553-6HA04	SIRIUS soft starter 200-480 V 720 A, 24 V AC/DC Screw terminals
3RW5553-6HA06	SIRIUS soft starter 200-690 V 720 A, 24 V AC/DC Screw terminals
3RW5553-6HA14	SIRIUS soft starter 200-480 V 720 A, 110-250 V AC Screw terminals
3RW5553-6HA16	SIRIUS soft starter 200-690 V 720 A, 110-250 V AC Screw terminals
3RW5554-2HA04	SIRIUS soft starter 200-480 V 840 A, 24 V AC/DC Spring-type terminals
3RW5554-2HA06	SIRIUS soft starter 200-690 V 840 A, 24 V AC/DC Spring-type terminals
3RW5554-2HA14	SIRIUS soft starter 200-480 V 840 A, 110-250 V AC Spring-type terminals
3RW5554-2HA16	SIRIUS soft starter 200-690 V 840 A, 110-250 V AC Spring-type terminals
3RW5554-6HA04	SIRIUS soft starter 200-480 V 840 A, 24 V AC/DC Screw terminals
3RW5554-6HA06	SIRIUS soft starter 200-690 V 840 A, 24 V AC/DC Screw terminals
3RW5554-6HA14	SIRIUS soft starter 200-480 V 840 A, 110-250 V AC Screw terminals
3RW5554-6HA16	SIRIUS soft starter 200-690 V 840 A, 110-250 V AC Screw terminals
3RW5556-2HA04	SIRIUS soft starter 200-480 V 1100 A, 24 V AC/DC Spring-type terminals
3RW5556-2HA06	SIRIUS soft starter 200-690 V 1100 A, 24 V AC/DC Spring-type terminals
3RW5556-2HA14	SIRIUS soft starter 200-480 V 1100 A, 110-250 V AC Spring-type terminals
3RW5556-2HA16	SIRIUS soft starter 200-690 V 1100 A, 110-250 V AC Spring-type terminals
3RW5556-6HA04	SIRIUS soft starter 200-480 V 1100 A, 24 V AC/DC Screw terminals
3RW5556-6HA06	SIRIUS soft starter 200-690 V 1100 A, 24 V AC/DC Screw terminals
3RW5556-6HA14	SIRIUS soft starter 200-480 V 1100 A, 110-250 V AC Screw terminals
3RW5556-6HA16	SIRIUS soft starter 200-690 V 1100 A, 110-250 V AC Screw terminals
3RW5558-2HA04	SIRIUS soft starter 200-480 V 1280 A, 24 V AC/DC Spring-type terminals
3RW5558-2HA06	SIRIUS soft starter 200-690 V 1280 A, 24 V AC/DC Spring-type terminals
3RW5558-2HA14	SIRIUS soft starter 200-480 V 1280 A, 110-250 V AC Spring-type terminals
3RW5558-2HA16	SIRIUS soft starter 200-690 V 1280 A, 110-250 V AC Spring-type terminals
3RW5558-6HA04	SIRIUS soft starter 200-480 V 1280 A, 24 V AC/DC Screw terminals
3RW5558-6HA06	SIRIUS soft starter 200-690 V 1280 A, 24 V AC/DC Screw terminals
3RW5558-6HA14	SIRIUS soft starter 200-480 V 1280 A, 110-250 V AC Screw terminals
3RW5558-6HA16	SIRIUS soft starter 200-690 V 1280 A, 110-250 V AC Screw terminals

3RW5544-2HF04	SIRIUS soft starter 200-480 V 250 A, 24 V AC/DC spring-type terminals Fail-safe
3RW5544-2HF14	SIRIUS soft starter 200-480 V 250 A, 110-250 V AC, spring-type terminals Fail-safe
3RW5544-6HF04	SIRIUS soft starter 200-480 V 250 A, 24 V AC/DC Screw terminals Fail-safe
3RW5544-6HF14	SIRIUS soft starter 200-480 V 250 A, 110-250 V AC, Screw terminals Fail-safe
3RW5545-2HF04	SIRIUS soft starter 200-480 V 315 A, 24 V AC/DC spring-type terminals Fail-safe
3RW5545-2HF14	SIRIUS soft starter 200-480 V 315 A, 110-250 V AC, spring-type terminals Fail-safe
3RW5545-6HF04	SIRIUS soft starter 200-480 V 315 A, 24 V AC/DC Screw terminals Fail-safe
3RW5545-6HF14	SIRIUS soft starter 200-480 V 315 A, 110-250 V AC, Screw terminals Fail-safe
3RW5546-2HF04	SIRIUS soft starter 200-480 V 370 A, 24 V AC/DC spring-type terminals Fail-safe
3RW5546-2HF14	SIRIUS soft starter 200-480 V 370 A, 110-250 V AC, spring-type terminals Fail-safe
3RW5546-6HF04	SIRIUS soft starter 200-480 V 370 A, 24 V AC/DC Screw terminals Fail-safe
3RW5546-6HF14	SIRIUS soft starter 200-480 V 370 A, 110-250 V AC, Screw terminals Fail-safe
3RW5547-2HF04	SIRIUS soft starter 200-480 V 470 A, 24 V AC/DC spring-type terminals Fail-safe
3RW5547-2HF14	SIRIUS soft starter 200-480 V 470 A, 110-250 V AC, spring-type terminals Fail-safe
3RW5547-6HF04	SIRIUS soft starter 200-480 V 470 A, 24 V AC/DC Screw terminals Fail-safe
3RW5547-6HF14	SIRIUS soft starter 200-480 V 470 A, 110-250 V AC, Screw terminals Fail-safe
3RW5548-2HF04	SIRIUS soft starter 200-480 V 570 A, 24 V AC/DC spring-type terminals Fail-safe
3RW5548-2HF14	SIRIUS soft starter 200-480 V 570 A, 110-250 V AC, spring-type terminals Fail-safe
3RW5548-6HF04	SIRIUS soft starter 200-480 V 570 A, 24 V AC/DC Screw terminals Fail-safe
3RW5548-6HF14	SIRIUS soft starter 200-480 V 570 A, 110-250 V AC, Screw terminals Fail-safe