

**SIEMENS**

*Ingenuity for life*

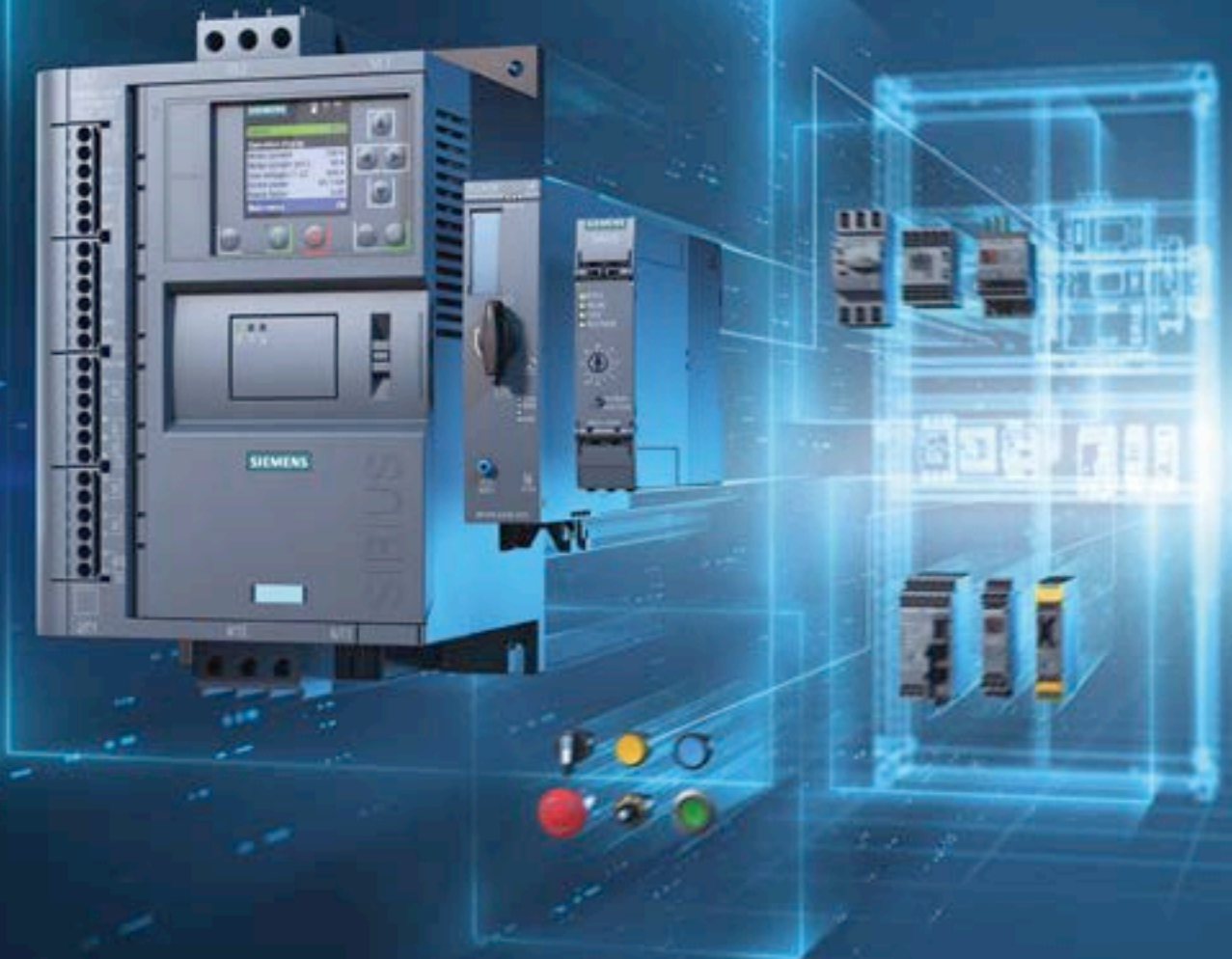

# Pioneering SIRIUS hybrid industrial controls

Starting motors with SIRIUS

SIRIUS  
Hybrid

[siemens.com/sirius-hybrid](https://www.siemens.com/sirius-hybrid)

# Control perfection with SIRIUS industrial controls

SIRIUS, the most modern, complete and innovated range of industrial controls can be subdivided into four core areas. They provide a good overview of the full spectrum of products and their functions.

## The most modern technology with a perfect design

The hybrid switching technology combines the best of relay and semiconductor switching technology: The devices switch electronically via the integrated power semiconductor, and then low-loss electromechanical bypass contacts take over the current flow during operation.



### SIRIUS Control

- Contactors
- Motor starter protectors
- Overload relay
- Infeed system
- Load feeders
- Reversing contactor assemblies
- Star-delta (wye-delta) combinations
- Contactor relays

### SIRIUS Command

- Pushbuttons and indicator lights
- Signaling columns
- Position and safety switches
- Cable-operated switches
- Foot switches
- Integrated signal lamps

### SIRIUS Monitor

- Safety relays
- AS-Interface
- SIMOCODE
- Coupling/time/monitoring relay
- Standstill and speed monitor

### SIRIUS Hybrid

- 3RW soft starters
- 3RM1 motor starters
- ET 200SP motor starters
- 3RF Solid-state switching devices



The SIRIUS 3RW5 soft starter received the RedDot Design and the iF Design awards thanks to numerous factors, including its slim, coordinated and uniform design across all sizes.

# Low-wear switching thanks to hybrid switching technology

The spectrum of the SIRIUS 3RW soft starters ranges from 2-phase controlled devices for standard applications all the way to high-performance 3-phase controlled equipment for demanding tasks. It covers all power ranges from 1.5 to 1200 kW and is therefore ideal for creating cost-optimized and suitable drive solutions for any application. At the same time, users benefit from substantial energy savings in operation. In the **3RW55 high performance range, the failsafe version** is unique. Thus, you are able to reduce costs due to space savings, and fewer components are required. For more information, see [www.siemens.com/IC10](http://www.siemens.com/IC10). For heavy starting, please always use the STS (Simulation Tool for Soft Starters) when selecting; see page 5.

## Reduced power losses in operation

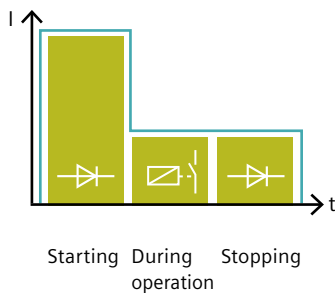

Conventional industrial controls result in wear to the mechanical switching contacts every time a system is switched on or off, albeit in very small increments. This is not the case with hybrid industrial controls, because the starting current is first engaged via electronic contact elements (Thyristor, Triac) and the mechanical contact elements are only engaged when the rated speed is reached. Thus, the mechanical components achieve a significantly higher switching service life.

## Advantages at a glance

- Longer service lives for controls
- Economic advantages with increased switching cycles
- Lower energy costs and lower temperature rise in the control panel
- Prevention of current peaks and network voltage dips
- Low interference emission; smaller electrical voltage fluctuations in power systems (flicker)
- Reduced power losses in operation

## SIRIUS 3RW soft starters at a glance

High Performance		<b>3RW55</b> 5.5 – 710/1,200 kW ( $\sqrt{3}$ )	$(\sqrt{3})$	3-phase controlled	TIA integration
		<b>3RW55 Failsafe</b> 5.5 – 315/560 kW ( $\sqrt{3}$ )			
General Performance		<b>3RW52</b> 5.5 – 315/560 kW ( $\sqrt{3}$ )	$(\sqrt{3})$	3-phase controlled	TIA integration
Basic Performance		<b>3RW50</b> 75 – 315 kW		2-phase controlled	TIA integration
		<b>3RW40</b> 5.5 – 55 kW			
		<b>3RW30</b> 1.5 – 55 kW			

Typical applications



# Good reasons for using soft starters

Motor voltage, current and torque effects differ considerably compared with those experienced in direct-on-line or star-delta (wye-delta) starting: Soft increase of the motor voltage, limited motor current and flat motor torque provide considerable advantages.

- Lower mechanical wear of the drive train due to limitation of the starting current/torque
- Protection of the network voltage from excessive starting peaks by reduced current consumption

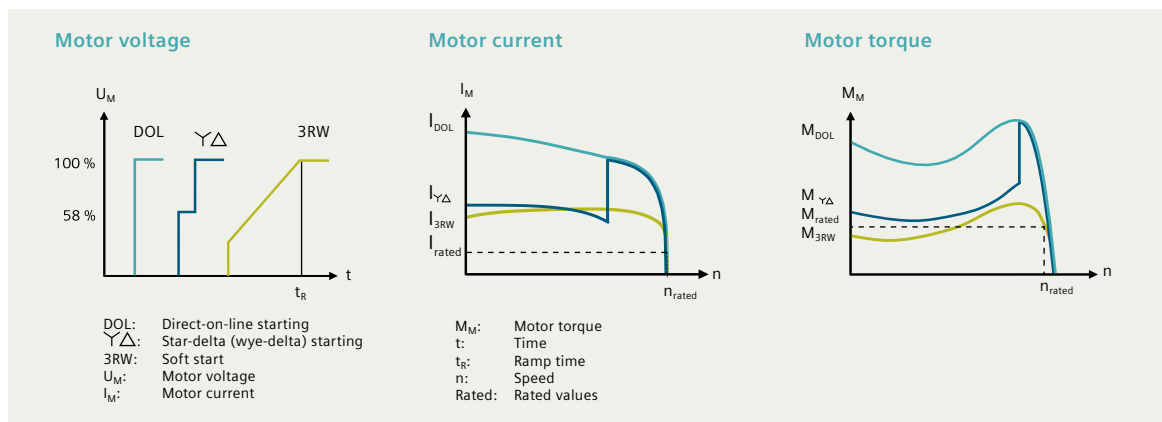

- Considerable savings on wiring in the control panel compared with a contactor assembly for star-delta (wye-delta) starting

**Circuit diagram for star-delta (wye-delta) starter**

**Circuit diagram for soft starter**

**Advantages at a glance**

- Minimum power loss due to integrated bypass contacts after successful startup
- No additional heat generation
- Low maintenance costs
- Compact design and low capital investment costs compared with frequency converters
- Substantial space savings in the control panel compared with a contactor assembly for star-delta (wye-delta) starting

# Simply the cleverer choice for many applications







There is no general answer to whether a soft starter or frequency converter is the optimum solution. The decisive factors are the application itself and its specific boundary conditions such as mechanical load, cost efficiency, compliance with standards, reliability, energy efficiency balance, etc.

## Added value due to soft starter

While, for applications with variable speeds, the use of a frequency converter is recommended, soft starters are always the first choice when the application does not require variable speed.

In this case, as a low-cost and low-maintenance drive solution that does not need extensive accessories, soft starters offer a whole range of advantages:

## Advantages of a soft starter at a glance

 <p>Lower capital investment costs</p>	 <p>Space savings thanks to compact design</p>	 <p>Low maintenance costs</p>
 <p>No additional heat generation</p>	 <p>Easy to wire</p>	 <p>Reduced energy losses during operation due to bypass contacts</p>
 <p>EMC-optimized for less interference from unwanted electrical or electromagnetic effects</p>		

## Selection of the right 3RW soft starter – engineering made easy

Specifying motor and load data results in the correct soft starter. For easy selection of the correctly dimensioned soft starter, two selection tools are available free of charge:

**STS** = Simulation Tool for Soft Starters as an application-specific selection guide;  
[www.siemens.com/sts](http://www.siemens.com/sts)

**TST** = TIA Selection Tool as a configurator;  
[www.siemens.com/tstcloud](http://www.siemens.com/tstcloud)

More information on these tools is available in Siemens Industry Online Support at [www.siemens.com/sios](http://www.siemens.com/sios) (keywords STS and TIA Selection Tool).

**Digital product data** for all common engineering tools make engineering simple.

# SIRIUS 3RW30

The SIRIUS 3RW30 soft starter for easy starting conditions

- Two-phase controlled
- Motors up to 55 kW at 400 V (max. 600 V AC)
- No smooth ramp-down (except 3RW3003)
- Very compact for space saving in the control panel
- Optimum adaptation to the drive task by individual potentiometers for starting voltage (40 ... 100%), startup time up to 20 s
- Modern hybrid switching technology

## SIRIUS 3RW30 soft starters

Rated operational voltage $U_e$	Rated operational current $I_e$ at 40 °C	Rated power of three-phase motors at rated operational voltage $U_e$		Size	Article No.	
		V	A			kW at 230 V
Soft starters for easy starting and runout conditions and high switching frequency						
200 ... 400	3		0.55	1.1	22.5 mm	3RW3003-□ CB5 4
Soft starters for three-phase asynchronous motors (without smooth ramp-down)						
200 ... 480	3.6		0.75	1.5	S00	3RW3013-□ BB□ 4
 Size S0	6.5		1.5	3	S00	3RW3014-□ BB□ 4
	9		2.2	4	S00	3RW3016-□ BB□ 4
	12.5		3	5.5	S00	3RW3017-□ BB□ 4
	17.6		4	7.5	S00	3RW3018-□ BB□ 4
	25		5.5	11	S0	3RW3026-□ BB□ 4
	32		7.5	15	S0	3RW3027-□ BB□ 4
	38		11	18.5	S0	3RW3028-□ BB□ 4
	45		11	22	S2	3RW3036-□ BB□ 4
	63		18.5	30	S2	3RW3037-□ BB□ 4
	72		22	37	S2	3RW3038-□ BB□ 4
	80		22	45	S3	3RW3046-□ BB□ 4
	106		30	55	S3	3RW3047-□ BB□ 4

□ = Article No. supplement for connection types:

□ = Article No. supplement for rated control supply voltage  $U_c$  :

\* Main connection from size S2: Screw terminals

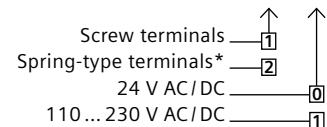

Dimensions W x H x D in mm		3RW300.	3RW301.	3RW302.	3RW303.	3RW304.
Screw terminals		22.5 x 100 x 120	45 x 95 x 151	45 x 125 x 151	55 x 144 x 168	70 x 160 x 186
Spring-type terminals		22.5 x 102 x 120	45 x 117 x 151	45 x 150 x 151	55 x 144 x 168	70 x 160 x 186

The 3RW soft starters should always be designed on the basis of the required rated operational current of the motor. The motor ratings listed in the selection and ordering data are rough guide values and designed for normal starting conditions (CLASS 10). For other starting conditions we recommend the Simulation Tool for Soft Starters (STS).

# SIRIUS 3RW40

The SIRIUS 3RW40 soft starter for simple starting **and** stopping conditions (not only soft starting but also soft stopping 0 ... 20 s and settable current limitation)

- Two-phase controlled
- Motors up to 55 kW at 400 V (max. 600 V AC)
- Integrated intrinsic device protection prevents overload of the device
- Perfect protection due to integrated motor overload protection (Class 10, 15, 20) and optional thermistor motor protection (see footer), manual and remote reset as standard
- Modern hybrid switching technology

## SIRIUS 3RW40 soft starters, Class 10

Rated operational voltage $U_e$	Rated operational current $I_e$ at 40 °C	Rated power of three-phase motors at rated operational voltage $U_e$		Size	Article No.	
		V	A			kW at 230 V
	200 ... 480	12.5	3	5.5	S0	3RW4024-□ BB□4
	25	5.5	11	S0	3RW4026-□ BB□4	
	32	7.5	15	S0	3RW4027-□ BB□4	
	38	11	18.5	S0	3RW4028-□ BB□4	
	45	11	22	S2	3RW4036-□ BB□4	
	63	18.5	30	S2	3RW4037-□ BB□4	
	72	22	37	S2	3RW4038-□ BB□4	
	80	22	45	S3	3RW4046-□ BB□4	
	106	30	55	S3	3RW4047-□ BB□4	

□ = Article No. supplement for connection types:

□ = Article No. supplement for rated control supply voltage  $U_s$ :

\* Main connection from size S2: Screw terminals

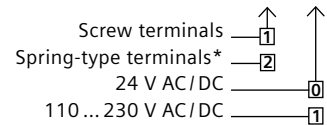

Dimensions W x H x D in mm		3RW402.	3RW403.	3RW404.
Screw terminals		45 x 125 x 154	55 x 144 x 170	70 x 160 x 188
Spring-type terminals		45 x 150 x 154	55 x 144 x 170	70 x 160 x 188

The following versions can also be supplied:

- For rated operational voltage 400 ... 600 V
- Sizes S0 to S3 with integrated thermistor motor protection (for motor with ThermoClick sensor or PTC type A) with rated control supply voltage  $U_s$  24 V AC/DC

The 3RW soft starters should always be designed on the basis of the required rated operational current of the motor. The motor ratings listed in the selection and ordering data are rough guide values and designed for normal starting conditions (CLASS 10). For other starting conditions we recommend the Simulation Tool for Soft Starters (STS).

# Optional accessories for SIRIUS 3RW30 and 3RW40

## Optional accessories for 3RW30 and 3RW40 soft starters

Link module soft starter to motor starter protector*	Soft starter		Motor starter protector	Article No.
	Type	Size	Size	
	With screw terminals			
	3RW301.	S00	S00	3RA2921-1BA00
	3RW302.	S0	S00/S0	3RA2921-1BA00
	3RW402.			
	3RW3036.	S2	S2	3RA2931-1AA00
	3RW4036.			
	3RW3046.	S3	S3	3RA1941-1AA00
	3RW3047.			
	3RW4046.			
3RW4047.				
With spring-type terminals				
	3RW301.	S00	S00	3RA2911-2GA00
	3RW302.	S0	S0	3RA2921-2GA00
	3RW402.			

\* Can be used in size S0 up to 32 A

In size S2 up to 65 A with DIN rail adapter for soft starter (article no.: 3RA2932-1CA00)

Can be used in size S3 with mounting plate only

## Optional accessories for the 3RW40 soft starter

Fan*	Soft starter		Article No.
	Type	Size	
	3RW402.	S0	3RW4928-8VB00
	3RW403.	S2	3RW4947-8VB00
	3RW404.	S3	

\* To increase switching frequency and for device mounting in positions different to the standard position



# Optional/included accessories for the SIRIUS 3RW50, 3RW52 and 3RW55 soft starters



Version	Soft starter	Optional/inclusive	Article No.	
<b>Hinged cover</b>				
Without cutout	3RW52	- / X	3RW5950-0GL20	
	3RW55	X / -		
With cutout for HMI Standard	3RW52	X / -	3RW5950-0GL40	
	3RW55	- / -		
With cutout for HMI High Feature	3RW52	X / -	3RW5950-0GL30	
	3RW55	- / X		
<b>HMI modules</b>				
Standard	3RW50	X / -	3RW5980-0HS00	
	3RW52	X / -		
	3RW55	- / -		
High Feature	3RW50	X / -	3RW5980-0HF00	
	3RW52	X / -		
	3RW55	- / X		
<b>Connecting cable for door mounting</b>				
5.0 m, round	3RW50/52/55	Accessories required for door mounting; length can be selected as required	3RW5980-0HC60	
2.5 m, round	3RW50/52/55		3UF7933-0BA00-0	
1.0 m, round	3RW50/52/55		3UF7937-0BA00-0	
0.5 m, round	3RW50/52/55		3UF7932-0BA00-0	
<b>Connecting cable for installation in the device</b>				
0.1 m, flat	3RW52	Accessories required for installation in the device	3UF7931-0AA00-0	
<b>Communication modules</b>				
PROFINET High Feature with integrated switch	3RW55	X / -	3RW5950-0CH00	
PROFINET Standard	3RW50/52/55	X / -	3RW5980-0CS00	
PROFIBUS	3RW50/52/55	X / -	3RW5980-0CP00	
EtherNet/IP	3RW50/52/55	X / -	3RW5980-0CE00	
Modbus RTU	3RW50/52/55	X / -	3RW5980-0CR00	
Modbus TCP	3RW50/52/55	X / -	3RW5980-0CT00	
COM connecting cable for mounting laterally on the device, 0.3 m	3RW50	Accessories required for lateral mounting	3RW5900-0CC00	
<b>Fan covers</b>				
	Required quantity	Soft starter	Optional	Article No.
	1x	3RW50	X	3RW5985-0FC00
	1x	3RW5216/5217	X	3RW5983-0FC00
		3RW551	X	
	2x	3RW5226/5227	X	3RW5983-0FC00
		3RW523	X	
		3RW552/553	X	
	1x	3RW524	X	3RW5984-0FC00
3RW554		X		

# SIRIUS 3RW50

The SIRIUS 3RW50 soft starter as a compact solution for standard applications

- 2-phase controlled
- For drives from 75 to 315 kW at 400V (max. 600 V AC)
- Soft starting and smooth ramp-down
- Current limitation and motor overload protection
- Optional HMI modules and communication modules (external connection)
- Optional analog output or thermistor motor protection
- Modern hybrid switching technology
- Small, compact design
- Parameter assignment by means of potentiometers
- Optional TIA integration

Soft starter as a compact solution for standard applications SIRIUS 3RW50, CLASS 10E, operating voltage 200 ... 480V

Rated voltage $U_e$	Rated current $I_e$ at 40 °C	Rated power of three-phase motors at rated voltage $U_e$		Size	Article No.
		kW at 230 V	kW at 400 V		
200 ... 480	143	37	75	S6	3RW5055-□□B□ 4
	171	45	90	S6	3RW5056-□□B□ 4
	210	55	110	S12	3RW5072-□□B□ 4
	250	75	132	S12	3RW5073-□□B□ 4
	315	90	160	S12	3RW5074-□□B□ 4
	370	110	200	S12	3RW5075-□□B□ 4
	470	132	250	S12	3RW5076-□□B□ 4
	570	160	315	S12	3RW5077-□□B□ 4

Electrical connection type for control circuit:

Product function:

Control supply voltage:

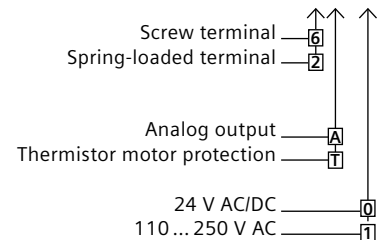

Mounting dimensions W x H x D in mm		3RW5055 / 3RW5056	3RW5072 / 3RW5073 / 3RW5074 / 3RW5075 / 3RW5076 / 3RW5077
		Screw mounting	120 x 198 x 249

The following versions are also available:  
 • for rated operational voltage 200 ... 600 V

The 3RW soft starters should always be designed on the basis of the required rated operational current of the motor. The motor ratings listed in the selection and ordering data are rough guide values and designed for basic starting conditions (CLASS 10). For other starting conditions we recommend the Simulation Tool for Soft Starters (STS).

# SIRIUS 3RW52

## The SIRIUS 3RW52 soft starter as an ideal solution for normal starting and stopping

- Three-phase controlled
- For drives from 5.5 to 560 kW at 400 V (maximum 600 V AC)
- Soft starting and smooth ramp-down
- Current limiting and motor overload protection
- Soft Torque (optimizes the acceleration shortly before the rated speed is reached and ensures a constant decrease in speed for a smooth ramp-down and thus an improved pump stopping mode)
- Optional HMI modules
- Plug-in communication modules (PROFINET, PROFIBUS; EtherNet/IP, Modbus)
- Optional software for optimum integration in the TIA Portal
- Modern hybrid switching technology

### SIRIUS 3RW52 soft starters for standard applications, Class 10A, operational voltage 200 ... 480 V

Rated current at 40°C in A		Rated power for three-phase motors		Size	Article No.	
Standard	$\sqrt{3}$	kW at 230 V	kW at 400 V		Inline circuit	Inside-delta circuit*
13	–	3	5.5	Size 1	3RW5213-□□C□ 4	–
18	–	4	7.5	Size 1	3RW5214-□□C□ 4	3RW5213-□□C□ 4
25	22.5	5.5	11	Size 1	3RW5215-□□C□ 4	3RW5213-□□C□ 4
32	31.5	7.5	15	Size 1	3RW5216-□□C□ 4	3RW5214-□□C□ 4
38	43.3	11	18.5	Size 1	3RW5217-□□C□ 4	3RW5215-□□C□ 4
47	55.4	11/15 ( $\sqrt{3}$ )	22	Size 2/Size 1 ( $\sqrt{3}$ )	3RW5224-□□C□ 4	3RW5216-□□C□ 4
63	65.8	18.5	30	Size 2/Size 1 ( $\sqrt{3}$ )	3RW5225-□□C□ 4	3RW5217-□□C□ 4
77	–	22	37	Size 2	3RW5226-□□C□ 4	3RW5224-□□C□ 4
93	81.4	22	45	Size 2	3RW5227-□□C□ 4	3RW5224-□□C□ 4
113	109	30	55	Size 3/Size 2 ( $\sqrt{3}$ )	3RW5234-□□C□ 4	3RW5225-□□C□ 4
143	133	37	75	Size 3/Size 2 ( $\sqrt{3}$ )	3RW5235-□□C□ 4	3RW5226-□□C□ 4
171	161	45	90	Size 3/Size 2 ( $\sqrt{3}$ )	3RW5236-□□C□ 4	3RW5227-□□C□ 4
210	196	55	110	Size 4/Size 3 ( $\sqrt{3}$ )	3RW5243-□□C□ 4	3RW5234-□□C□ 4
250	248	75	132	Size 4/Size 3 ( $\sqrt{3}$ )	3RW5244-□□C□ 4	3RW5235-□□C□ 4
315	296	90	160	Size 4/Size 3 ( $\sqrt{3}$ )	3RW5245-□□C□ 4	3RW5236-□□C□ 4
370	364	110	200	Size 4	3RW5246-□□C□ 4	3RW5243-□□C□ 4
470	433	132	250	Size 4	3RW5247-□□C□ 4	3RW5244-□□C□ 4
570	546	160	315	Size 4	3RW5248-□□C□ 4	3RW5245-□□C□ 4
–	641	200	355	Size 4	–	3RW5246-□□C□ 4
–	814	250	400	Size 4	–	3RW5247-□□C□ 4
–	987	315	560	Size 4	–	3RW5248-□□C□ 4

Electrical connection type for control circuit:

Product function:

Control supply voltage:

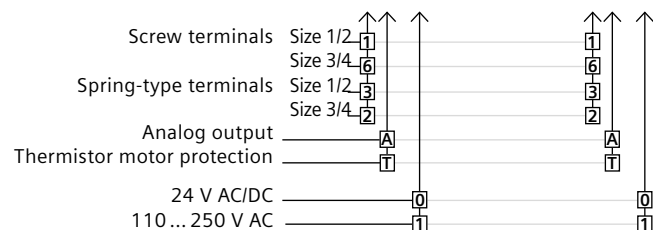

Dimensions W x H x D in mm		3RW521.	3RW522., 3RW523.	3RW524.
Screw fixing		170 x 275 x 152	185 x 306 x 203	210 x 393 x 203

The following versions are also available: for rated operational voltage 200 ... 600 V

The 3RW soft starters should always be designed on the basis of the required rated operational current of the motor. The motor ratings listed in the selection and ordering data are rough guide values and designed for normal starting conditions (CLASS 10). For other starting conditions we recommend the Simulation Tool for Soft Starters (STS).

# SIRIUS 3RW55

The SIRIUS 3RW55 soft starter as a perfect solution for difficult starting and stopping operations

- Three-phase controlled
- For drives from 5.5 to 1200 kW at 400 V (can be used in supply systems up to 690 V)
- Soft starting and stopping
- Current limiting and motor overload protection
- Pump stop and torque control
- Plug-in communication modules (PROFINET, PROFIBUS; Modbus)
- Automatic parameterization
- Removable HMI module with color display and slot for micro SD memory card
- Optional integration into the TIA Portal
- Modern hybrid industrial controls
- also available as failsafe version

Soft starter for difficult starting and stopping, SIRIUS 3RW55, Class 10E, operational voltage 200 ... 480 V

Rated current at 40°C in A		Rated power for three-phase motors		Size	Article No.	Article No.
Standard	$\sqrt{3}$	kW at 230 V	kW at 400 V		Inline circuit	Inside-delta circuit*
13	–	3	5.5	Size 1	3RW5513-□ HA□ 4	–
18	–	4	7.5	Size 1	3RW5514-□ HA□ 4	3RW5513-□ HA□ 4
25	22.5	5.5	11	Size 1	3RW5515-□ HA□ 4	3RW5513-□ HA□ 4
32	31.5	7.5	15	Size 1	3RW5516-□ HA□ 4	3RW5514-□ HA□ 4
38	43.3	11	18.5	Size 1	3RW5517-□ HA□ 4	3RW5515-□ HA□ 4
47	55.4	11/15 ( $\sqrt{3}$ )	22	Size 2/Size 1 ( $\sqrt{3}$ )	3RW5524-□ HA□ 4	3RW5516-□ HA□ 4
63	65.8	18.5	30	Size 2/Size 1 ( $\sqrt{3}$ )	3RW5525-□ HA□ 4	3RW5517-□ HA□ 4
77	–	22	37	Size 2	3RW5526-□ HA□ 4	3RW5524-□ HA□ 4
93	81.4	22	45	Size 2	3RW5527-□ HA□ 4	3RW5524-□ HA□ 4
113	109	30	55	Size 3/Size 2 ( $\sqrt{3}$ )	3RW5534-□ HA□ 4	3RW5525-□ HA□ 4
143	133	37	75	Size 3/Size 2 ( $\sqrt{3}$ )	3RW5535-□ HA□ 4	3RW5526-□ HA□ 4
171	161	45	90	Size 3/Size 2 ( $\sqrt{3}$ )	3RW5536-□ HA□ 4	3RW5527-□ HA□ 4
210	196	55	110	Size 4/Size 3 ( $\sqrt{3}$ )	3RW5543-□ HA□ 4	3RW5534-□ HA□ 4
250	248	75	132	Size 4/Size 3 ( $\sqrt{3}$ )	3RW5544-□ HA□ 4	3RW5535-□ HA□ 4
315	296	90	160	Size 4/Size 3 ( $\sqrt{3}$ )	3RW5545-□ HA□ 4	3RW5536-□ HA□ 4
370	364	110	200	Size 4	3RW5546-□ HA□ 4	3RW5543-□ HA□ 4
470	433	132	250	Size 4	3RW5547-□ HA□ 4	3RW5544-□ HA□ 4
570	546	160	315	Size 4	3RW5548-□ HA□ 4	3RW5545-□ HA□ 4
–	641	200	355	Size 4	–	3RW5546-□ HA□ 4
–	814	250	400	Size 4	–	3RW5547-□ HA□ 4
–	987	315	560	Size 4	–	3RW5548-□ HA□ 4

Electrical connection type for control circuit:

Control supply voltage:

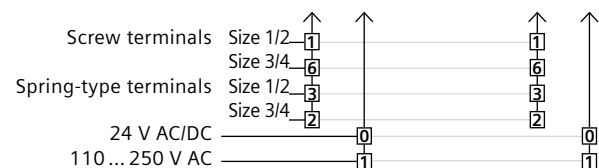

Dimensions W x H x D in mm		3RW551.	3RW552., 3RW553.	3RW554.
Screw fixing		170 x 275 x 152	185 x 306 x 203	210 x 393 x 203

Devices with higher output in size 5 and the following versions are also available: for rated operational voltage 200 ... 600 V (3RW551) and 200 ... 690 V (3RW552, 3RW553 and 3RW554). The 3RW soft starters should always be designed on the basis of the required rated operational current of the motor. The motor ratings listed in the selection and ordering data are rough guide values and designed for normal starting conditions (CLASS 10). For other starting conditions we recommend the Simulation Tool for Soft Starters (STS).

# SIRIUS 3RW55 Failsafe

The SIRIUS 3RW55 Failsafe soft starter with an integrated fail-safe digital input as a perfect solution for difficult starting and ramp-down procedures

Integrated Safe Torque Off function (STO)

- 3-phase controlled
- For drives from 5.5 to 560 kW
- Soft starting and smooth ramp-down
- Fail-safe disconnection up to SIL3, PL e / STO
- Pump stop and torque control
- Plug-in communication modules (PROFINET, PROFIBUS; EtherNet/IP, Modbus)
- Automatic parameter assignment
- Removable HMI module with color display and slot for micro SD memory card
- Optional TIA Portal integration
- Modern hybrid industrial controls

## Soft starter with integrated fail-safe digital input SIRIUS 3RW55 Failsafe, Class 10E, operating voltage 200...480 V

Rated current at 40 °C in A		Rated power for three-phase motors		Size	Article No.	
Standard	$\sqrt{3}$	kW at 230 V	kW at 400 V		Standard circuit	Inside-delta circuit
13	-	3	5.5	Size 1	3RW5513-□ HF□ 4	-
18	-	4	7.5	Size 1	3RW5514-□ HF□ 4	-
25	22.5	5.5	11	Size 1	3RW5515-□ HF□ 4	3RW5513-□ HF□ 4
32	31.5	7.5	15	Size 1	3RW5516-□ HF□ 4	3RW5514-□ HF□ 4
38	43.3	11	18.5	Size 1	3RW5517-□ HF□ 4	3RW5515-□ HF□ 4
47	55.4	11/15 ( $\sqrt{3}$ )	22	Size 2/Size 1 ( $\sqrt{3}$ )	3RW5524-□ HF□ 4	3RW5516-□ HF□ 4
63	65.8	18.5	30	Size 2/Size 1 ( $\sqrt{3}$ )	3RW5525-□ HF□ 4	3RW5517-□ HF□ 4
77	-	22	37	Size 2	3RW5526-□ HF□ 4	-
93	81.4	22	45	Size 2	3RW5527-□ HF□ 4	3RW5524-□ HF□ 4
113	109	30	55	Size 3/Size 2 ( $\sqrt{3}$ )	3RW5534-□ HF□ 4	3RW5525-□ HF□ 4
143	133	37	75	Size 3/Size 2 ( $\sqrt{3}$ )	3RW5535-□ HF□ 4	3RW5526-□ HF□ 4
171	161	45	90	Size 3/Size 2 ( $\sqrt{3}$ )	3RW5536-□ HF□ 4	3RW5527-□ HF□ 4
210	196	55	110	Size 4/Size 3 ( $\sqrt{3}$ )	3RW5543-□ HF□ 4	3RW5534-□ HF□ 4
250	248	75	132	Size 4/Size 3 ( $\sqrt{3}$ )	3RW5544-□ HF□ 4	3RW5535-□ HF□ 4
315	296	90	160	Size 4/Size 3 ( $\sqrt{3}$ )	3RW5545-□ HF□ 4	3RW5536-□ HF□ 4
370	364	110	200	Size 4	3RW5546-□ HF□ 4	3RW5543-□ HF□ 4
470	433	132	250	Size 4	3RW5547-□ HF□ 4	3RW5544-□ HF□ 4
570	546	160	315	Size 4	3RW5548-□ HF□ 4	3RW5545-□ HF□ 4
-	641	200	355	Size 4	-	3RW5546-□ HF□ 4
-	814	250	400	Size 4	-	3RW5547-□ HF□ 4
-	987	315	560	Size 4	-	3RW5548-□ HF□ 4

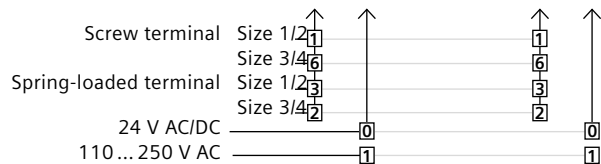

Mounting dimensions WxHxD in mm		3RW551.	3RW552., 3RW553.	3RW554.
Screw mounting		170 x 275 x 152	185 x 306 x 203	210 x 393 x 203

The 3RW soft starters should always be designed on the basis of the required rated operational current of the motor. The motor ratings listed in the selection and ordering data are rough guide values and designed for basic starting conditions (CLASS 10). For other starting conditions we recommend the Simulation Tool for Soft Starters (STS).

# Soft starter instead of star-delta

## Less is more when it comes to benefits

Star-delta combinations (also known as wye-delta starters) are a traditional solution for preventing unpleasant side effects when starting motors, such as voltage dips in the grid and strong transient torques in the mechanical system. Modern hybrid switching solutions can also master these challenges as well as provide additional functionality, resulting in additional advantages.

- Use modern hybrid industrial controls for less wear of the switching contacts, because the starting current is first engaged via the electronic contact elements (Thyristor, Triac) and the mechanical contact elements are only engaged when the rated speed is reached
- More functions than star-delta (wye-delta) circuits: soft and reduced-current starting, soft ramp-down, etc.
- Only one device and thus, significantly less wiring and ordering costs and efforts; less space required
- Considerably more flexible and more powerful, because of the precise setting options for the starting conditions

## Use of a SIRIUS 3RW52 and 3RW55 soft starter in standard or inside-delta circuit

When considering replacing a star-delta (wye-delta) combination with a soft starter, the question of whether to use standard wiring or inside-delta wiring automatically arises. Therefore, when selecting a 3-phase controlled soft starter, the two options of standard circuit or inside-delta circuit should always be checked (see selection tables on previous pages).

With an inside-delta circuit, the motor current which flows through the soft starter is reduced by the factor of  $\sqrt{3}$ , therefore a smaller soft starter can be

selected. This reduces costs and the wiring setup can be used almost unchanged.

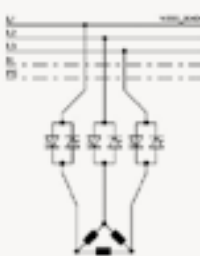
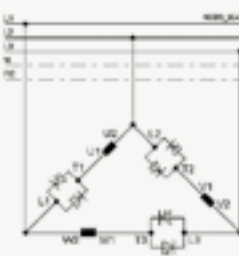
	<p><b>Inline circuit</b></p> <ul style="list-style-type: none"> <li>• Easier wiring (3 wires)</li> <li>• Compared with an inside-delta circuit, a larger soft starter must be selected</li> </ul>		<p><b>Inside-delta circuit</b></p> <ul style="list-style-type: none"> <li>• More complicated wiring (6 wires, smaller conductor cross-section can be used than for an inline circuit)</li> <li>• Star-delta (wye-delta) easily replaceable by inside-delta soft starter solution thanks to existing wiring</li> <li>• Selection of a smaller soft starter at a lower price is possible because the motor current flowing through the soft starter is reduced by a factor of <math>\sqrt{3}</math></li> </ul>
-------------------------------------------------------------------------------------	---------------------------------------------------------------------------------------------------------------------------------------------------------------------------------------------------	--------------------------------------------------------------------------------------	--------------------------------------------------------------------------------------------------------------------------------------------------------------------------------------------------------------------------------------------------------------------------------------------------------------------------------------------------------------------------------------------------------------------------------------------------------------------------------------------------------------

# 3RM1 and ET 200SP motor starters

For starting one or more motors, the local conditions and the requirements of the application are very different. For that reason, Siemens offers other solutions to start motors using modern hybrid industrial controls, with all the advantages associated: 3RM1 motor starters, when space is at a premium, or ET 200SP motor starters for active communication with the controller, despite confined space.



## You choose which solution is the most suitable.



Both starters can be ordered as direct-on-line starters and reversing starters.



You decide between spring-type or screw terminals.



Even safety applications are no problem because both starters are also available as a failsafe version.

# 3RM1 motor starters

If every millimeter in the control panel counts, the 3RM1 motor starters with hybrid switching technology are the perfect solution for starting motors up to 3 kW (at 400 V).



- In a width of only 22.5 mm
- Relay contacts, power semiconductors and electronic overload relays (overload protection) in one device
- Available as direct-on-line and reversing starters
- Versions with safety-related shutdown up to SIL3/PL e
- Three-phase infeed system for easy, time-saving and safe infeed of two or more motor starters
- Wide setting range for reduction of variants
- Group configurations in the smallest possible space
- Replaceable terminals (screw and spring-type connections)
- Modern hybrid switching technology

**Motor starter as a direct-on-line or reversing starter, with/without failsafe, dimensions in mm (W x H x D) 22.5 x 100 x 141.6**

Rating for three-phase motor at 400 V in kW	Setting range for electronic overload in A	Control supply voltage in V		Article No.	
		at DC	at 50/60 Hz AC	3RM1 direct-on-line starter	3RM1 reversing starter
0...0.12	0.1...0.5	24	–	3RM1001-□ AA04	3RM1201-□ AA04
0.09...0.75	0.4...2	24	–	3RM1002-□ AA04	3RM1202-□ AA04
0.55...3	1.6...7	24	–	3RM1007-□ AA04	3RM1207-□ AA04
0...0.12	0.1...0.5	110	110...230	3RM1001-□ AA14	3RM1201-□ AA14
0.09...0.75	0.4...2	110	110...230	3RM1002-□ AA14	3RM1202-□ AA14
0.55...3	1.6...7	110	110...230	3RM1007-□ AA14	3RM1207-□ AA14
<b>Failsafe</b>					
0...0.12	0.1...0.5	24	–	3RM1101-□ AA04	3RM1301-□ AA04
0.09...0.75	0.4...2	24	–	3RM1102-□ AA04	3RM1302-□ AA04
0.55...3	1.6...7	24	–	3RM1107-□ AA04	3RM1307-□ AA04
0...0.12	0.1...0.5	110	110...230	3RM1101-□ AA14	3RM1301-□ AA14
0.09...0.75	0.4...2	110	110...230	3RM1102-□ AA14	3RM1302-□ AA14
0.55...3	1.6...7	110	110...230	3RM1107-□ AA14	3RM1307-□ AA14

Type of electrical connection:

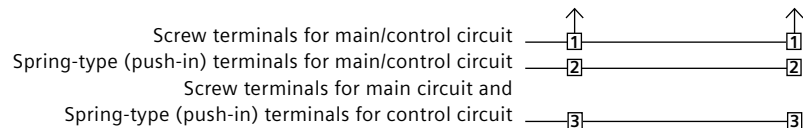

## Optional accessories for the 3RM1 motor starter



Version	Article No.
Device connector for 3RM1, 24 V DC	3ZY1212-2EA00
Device terminating connector for 3RM1, 24 V DC	3ZY1212-2FA00
<b>Three-phase infeed system for 3RM1 with screw terminals</b>	
Three-phase infeed terminal	3RM1920-1AA
Three-phase busbar for 2 motor starters	3RM1910-1AA
Three-phase busbar for 3 motor starters	3RM1910-1BA
Three-phase busbar for 5 motor starters	3RM1910-1DA
Covers for 3 connection tags of the three-phase busbars	3RM1910-6AA



# ET 200SP motor starters

The SIMATIC ET 200SP motor starter completes the distributed I/O system. With transmission of current values (energy management) and further analysis and diagnostics data (alarm status display), it offers a variety of options for plant monitoring and optimization.



- Only 30 mm module width
- Controlling, switching, starting and monitoring in the ET 200SP system
- Switching and protecting 1 and 3-phase loads up to 5.5 kW in five wide setting ranges
- Integrated short-circuit and overload protection
- Fast maintenance thanks to automatic parameter uploading
- Spring-loaded terminal (push-in)
- Toolless connection system
- One ordering unit always consists of a motor starter with a BaseUnit
- Connect main and supply voltage only once, i.e.: side-by-side modules are automatically connected
- Unplugging/plugging possible while system is energized and the ET 200SP station is running
- Modern hybrid switching technology

## Motor Starter ET 200SP, dimensions in mm (W x H x D) 30 x 142 x 150

Max. current carrying capacity at startup in A	Setting range for electronic overload in A	Electronic overload protection at 400 V up to (kW)	Article No.	
			Direct-on-line starter	Reversing starters
4	0.1...0.4	0.09	3RK1308-0□ A00-OCPO	3RK1308-0□ A00-OCPO
10	0.3...1	0.25	3RK1308-0□ B00-OCPO	3RK1308-0□ B00-OCPO
30	0.9...3	1.1	3RK1308-0□ C00-OCPO	3RK1308-0□ C00-OCPO
90	2.8...9	4	3RK1308-0□ D00-OCPO	3RK1308-0□ D00-OCPO
100	4...12	5.5	3RK1308-0□ E00-OCPO	3RK1308-0□ E00-OCPO

Standard  $\uparrow$  A
Standard  $\uparrow$  B  
Failsafe  $\downarrow$  C
Failsafe  $\downarrow$  D

## BaseUnits, operating voltage rated value up to 500 V, dimensions in mm (W x H x D) 30 x 215 x 75

BaseUnits version <sup>1)</sup>	Operating voltage of the AC infeed in V	Supply voltage of the DC infeed in V	Article No.
With AC/DC infeed (standard)	500	24	3RK1908-0AP00-0APO
Without infeed (standard)	–	–	3RK1908-0AP00-0DPO
With AC infeed, with F-DI infeed (Failsafe)	500	–	3RK1908-0AP00-0GPO
Without AC/DC infeed, with F-DI forwarding (Failsafe)	–	–	3RK1908-0AP00-0JPO

<sup>1)</sup> The voltage is looped through from BaseUnits with infeed to downstream BaseUnits without infeed.

## BaseUnits for empty modules upstream of the first motor starter (for interference-proof operation)

Version	Article No.
Light, opening a new potential group	6ES7193-6BP00-0DA0
Dark, looping through the potential group	6ES7193-6BP00-0BA0
Cover for empty modules, 15 mm	6ES7133-6CV15-1AM0

## Optional accessories

Version	Article No.
Control Module 3DI/LC (push-in terminal, control supply voltage for DC rated value 20.4 ... 28.8 V), dimensions in mm (W x H x D) 30 x 54.5 x 42.3	3RK1908-1AA00-0BP0
Fans (already incl. at 12 A)	3RW4928-8VB00
Additional mechanical mounting, bag of 5 items	3RK1908-1EA00-1BP0

**Published by  
Siemens AG**

Smart Infrastructure  
Electrical Products  
Werner-von-Siemens-Str. 48-50  
92224 Amberg  
Germany

**For the U.S. published by  
Siemens Industry Inc.**

100 Technology Drive  
Alpharetta, GA 30005  
United States

Article No.: SIEP-B10001-00-7600  
Dispo 18101 WS 04203.0  
Printed in Germany  
© Siemens 2020

Subject to changes and errors. The information given in this document only contains general descriptions and/or performance features which may not always specifically reflect those described, or which may undergo modification in the course of further development of the products. The requested performance features are binding only when they are expressly agreed upon in the concluded contract. Subject to change without prior notice.

All product designations may be trademarks or product names of Siemens AG or supplier companies whose use by third parties for their own purposes could violate the rights of the owners.

**Security notes**

Siemens provides products and solutions with industrial security functions that support the secure operation of plants, systems, machines and networks.

In order to protect plants, systems, machines and networks against cyber threats, it is necessary to implement – and continuously maintain – a holistic, state-of-the-art industrial security concept. Products and solutions from Siemens constitute one element of such a concept.

Customers are responsible for preventing unauthorized access to their plants, systems, machines and networks. Such systems, machines and components should only be connected to an enterprise network or the Internet if and to the extent such a connection is necessary and only when appropriate security measures (e.g. firewalls and/or network segmentation) are in place.

For additional information on industrial security measures that can be implemented, please visit:

**<https://www.siemens.com/industrialsecurity>**

Siemens' products and solutions undergo continuous development to make them more secure. Siemens strongly recommends that product updates are applied as soon as they become available, and that only the latest product versions are used. Use of product versions that are no longer supported, and failure to apply latest updates may increase customer's exposure to cyber threats.

To stay informed about product updates, subscribe to the Siemens Industrial Security RSS Feed under  
**<https://www.siemens.com/industrialsecurity>**.











3RW5247-2AC15	SIRIUS soft starter 200-600 V 470 A, 110-250 V AC spring-type terminals Analog output
3RW5247-2TC04	SIRIUS soft starter 200-480 V 470 A, 24 V AC/DC spring-type terminals Thermistor input
3RW5247-2TC05	SIRIUS soft starter 200-600 V 470 A, 24 V AC/DC spring-type terminals Thermistor input
3RW5247-2TC14	SIRIUS soft starter 200-480 V 470 A, 110-250 V AC spring-type terminals Thermistor input
3RW5247-2TC15	SIRIUS soft starter 200-600 V 470 A, 110-250 V AC spring-type terminals Thermistor input
3RW5247-6AC04	SIRIUS soft starter 200-480 V 470 A, 24 V AC/DC Screw terminals Analog output
3RW5247-6AC05	SIRIUS soft starter 200-600 V 470 A, 24 V AC/DC Screw terminals Analog output
3RW5247-6AC14	SIRIUS soft starter 200-480 V 470 A, 110-250 V AC Screw terminals Analog output
3RW5247-6AC15	SIRIUS soft starter 200-600 V 470 A, 110-250 V AC Screw terminals Analog output
3RW5247-6TC04	SIRIUS soft starter 200-480 V 470 A, 24 V AC/DC Screw terminals Thermistor input
3RW5247-6TC05	SIRIUS soft starter 200-600 V 470 A, 24 V AC/DC Screw terminals Thermistor input
3RW5247-6TC14	SIRIUS soft starter 200-480 V 470 A, 110-250 V AC Screw terminals Thermistor input
3RW5247-6TC15	SIRIUS soft starter 200-600 V 470 A, 110-250 V AC Screw terminals Thermistor input
3RW5248-2AC04	SIRIUS soft starter 200-480 V 570 A, 24 V AC/DC spring-type terminals Analog output
3RW5248-2AC05	SIRIUS soft starter 200-600 V 570 A, 24 V AC/DC spring-type terminals Analog output
3RW5248-2AC14	SIRIUS soft starter 200-480 V 570 A, 110-250 V AC spring-type terminals Analog output
3RW5248-2AC15	SIRIUS soft starter 200-600 V 570 A, 110-250 V AC spring-type terminals Analog output
3RW5248-2TC04	SIRIUS soft starter 200-480 V 570 A, 24 V AC/DC spring-type terminals Thermistor input
3RW5248-2TC05	SIRIUS soft starter 200-600 V 570 A, 24 V AC/DC spring-type terminals Thermistor input
3RW5248-2TC14	SIRIUS soft starter 200-480 V 570 A, 110-250 V AC spring-type terminals Thermistor input
3RW5248-2TC15	SIRIUS soft starter 200-600 V 570 A, 110-250 V AC spring-type terminals Thermistor input
3RW5248-6AC04	SIRIUS soft starter 200-480 V 570 A, 24 V AC/DC Screw terminals Analog output
3RW5248-6AC05	SIRIUS soft starter 200-600 V 570 A, 24 V AC/DC Screw terminals Analog output
3RW5248-6AC14	SIRIUS soft starter 200-480 V 570 A, 110-250 V AC Screw terminals Analog output
3RW5248-6AC15	SIRIUS soft starter 200-600 V 570 A, 110-250 V AC Screw terminals Analog output
3RW5248-6TC04	SIRIUS soft starter 200-480 V 570 A, 24 V AC/DC Screw terminals Thermistor input
3RW5248-6TC05	SIRIUS soft starter 200-600 V 570 A, 24 V AC/DC Screw terminals Thermistor input
3RW5248-6TC14	SIRIUS soft starter 200-480 V 570 A, 110-250 V AC Screw terminals Thermistor input
3RW5248-6TC15	SIRIUS soft starter 200-600 V 570 A, 110-250 V AC Screw terminals Thermistor input