



**Gate, Globe, Check & Ball  
Production**



GATE, GLOBE and CHECK VALVES DIVISION



BALL VALVES DIVISION



WAREHOUSE



LVF HEAD OFFICES AND MANUFACTURING PLANT

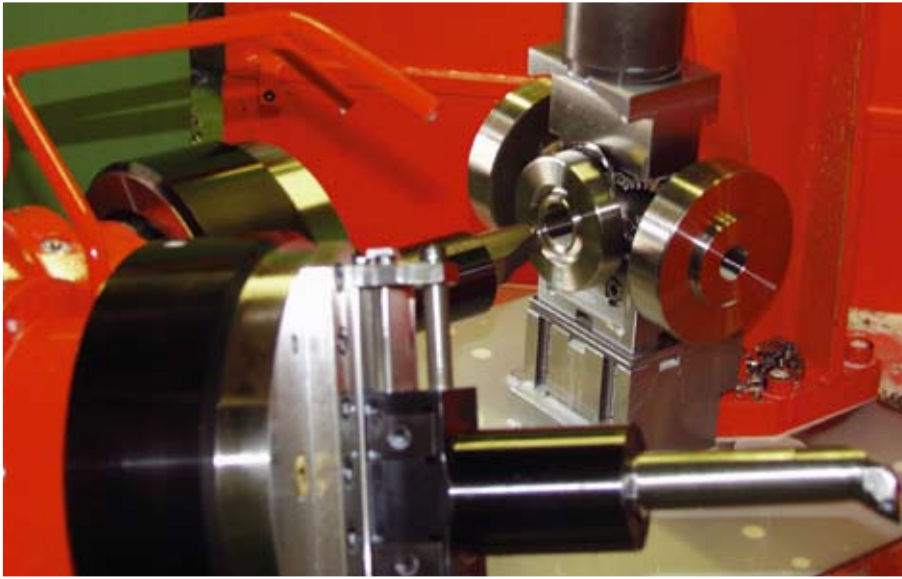

# CERT

## QUALITY PROCEDURES IN THE MOST STRINGENT

LVF's production, is obtained with modern plant and equipment that assure a product of the highest quality checked by qualified and experienced technicians.

The latest generation of C.N.C. equipment designed and modified to the specifications of the company's Technical Department guarantees optimal results on finished bodies and bonnets.

Qualified and reliable subcontractors assure materials of the highest quality in complete compliance with the required applicable standards.

A well integrated combination of Quality Assurance and Quality Control Procedures permitted LVF to obtain the first certificate of approval ISO 9001 from BUREAU VERITAS QUALITY INTERNATIONAL on the 6th October 1992.



LVF - Production area Automatic machine

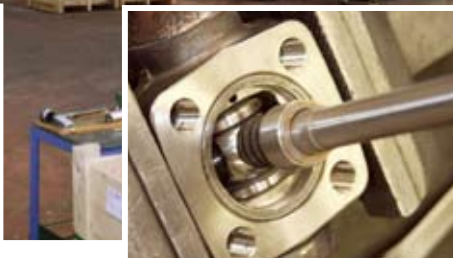

This page gives a summary description of LVF and its valve production for use in the petrochemical and allied industries, and conventional and nuclear power generation plants.

Since its establishment, LVF has designed and manufactured its own forged steel valves, with particular attention to the heavy duty type valves and special applications. The company's product development and continuous growth has led to the decision to devote all the company's efforts to a manufacturing and sales strategy aimed at entering the international market. Auxiliary structures have been set up to meet the worldwide demand for quality products and reliable deliveries.

Modern equipment for inspection and testing guarantee conformity to the most stringent requirements of related specifications. Sophisticated equipment for the real valve flow coefficient (CV) measurement as well as FEA (Final Element Analysis) are available in our laboratory, so LVF is able to certify CV values, an extremely important parameter in the correct choice of the valve type during plant design.

Modern equipment to verify the functioning of bellows seal valves, not limited to structural control of the bellows, but offering a full analysis of the valve under simulated working conditions is also available.

External laboratories are used to check and certify the chemical and mechanical properties of the materials employed.

Substantial capital investment has also been made for the installation of the latest generation of high quality CNC machinery which allows LVF to meet rapidly all its customers' different delivery requirements through its



LVF - Computerized automatically warehouse

highly flexible production planning and control systems. LVF's policy is ongoing technological progress and product improvement, conscious that quality always assures reliability.



The highest quality and variety of materials used (carbon steels, alloy steels, stainless steels, duplex steels, monel, titanium, hastelloy, inconel and incoloy) can satisfy all the requirements of chemical, petrochemical and power plants, oil and gas off-shore & on-shore, ship building, water treatment, paper and pulp, energy generation, and for chlorine, hydrogen, oxygen and sour service industries.

Each valve is manufactured in accordance with the relevant API, ANSI, DIN and BS standard and is supplied with certificates according to the relevant standards specifications.

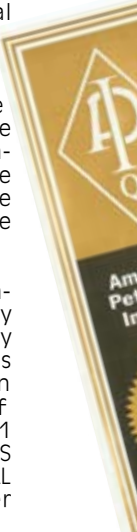

# TIFICATION

DESIGNED AND DEVELOPED IN ACCORDANCE WITH REQUIREMENTS OF THE API AND ISO 9001 STANDARDS

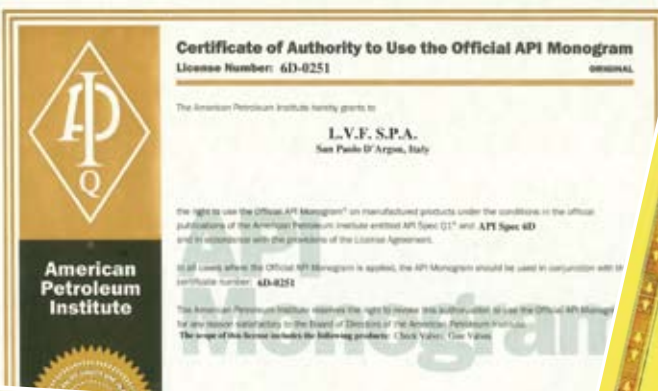

# TECHNOLOGY



**DESIGN DEPARTMENT  
- CAD-STATION -  
Our ultra-modern equipment  
consolidated know-how**



**AUTOMATIC MACHINE - Technology and automation  
guarantee productivity and quality**



**COMPUTERIZED WAREHOUSE -  
Assure a rapid respond on customer requests**



# NAME PLATE OF IDENTIFICATION

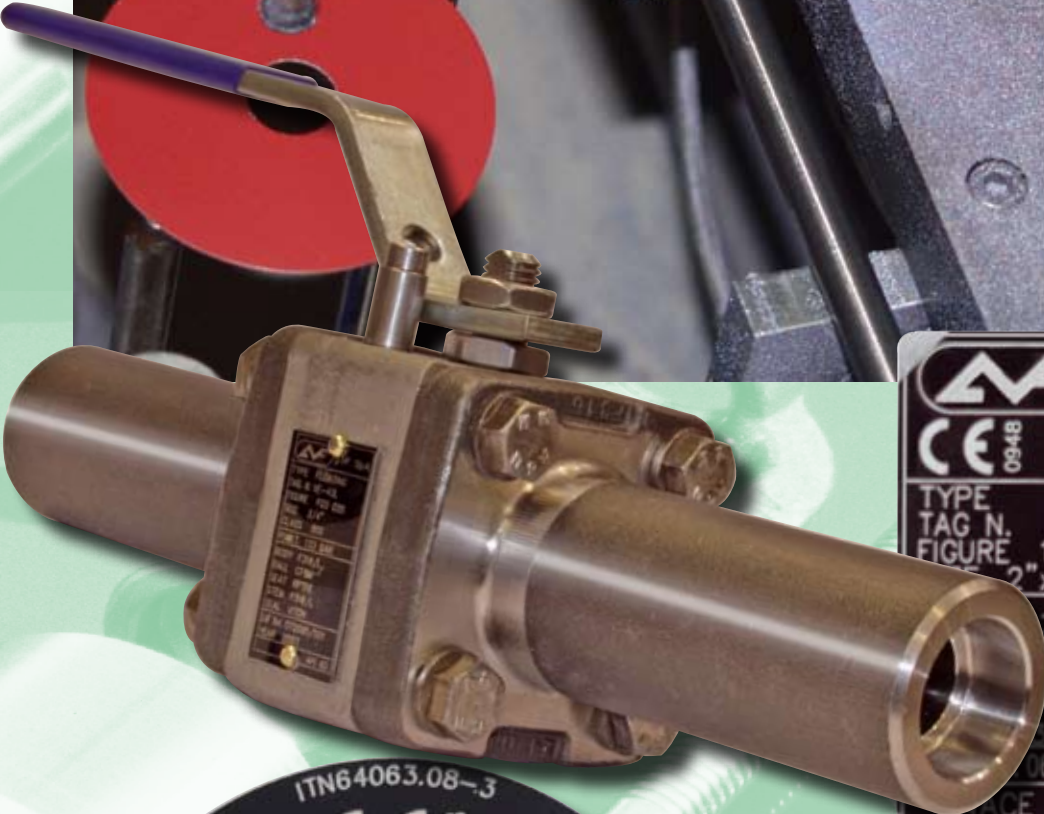

		LVF SpA	
CE 0948		SAN PAOLO D'ARGON	
		BERGAMO - ITALY	
TYPE	FLOATING		
TAG N.	FIGURE 1F02_Q50R		
FIGURE	2" x 1.1/2"	CLASS	150
	-10	T Max (C)	220
	1 BAR	PSOT Max	16,98 BAR
	05N	SEAT	RPTFE
	BM	SEAL	VITON
	16/L	YEAR	2008
	061879/018		
	NACE MR0175	API	6D
	NACE MR0103		

ITN64063.08-3

CE 0948		TYPE GLOBE	
FIGURE	1BR 207	SIZE	1.1/2"
BODY	F316/L	CLASS	150
STEM	F316/L	YEAR	2005
DISC	F316HF	JOB/POS	050271/003
SEAT	F316HF	T Max (C)	100
T Min (C)	-29	PSOT max	16,7 BAR
PSOT min	20 BAR	NACE MR 0175	ASME B16.34
LVF SpA		- Italy -	

CE 0948		TYPE GATE	
FIGURE	BR 107	SIZE	1.1/2"
BODY	A105N	CLASS	800
STEM	F 316/L	YEAR	2004
WEDGE	F6 NACE	JOB/POS	045101/006
SEAT	F6HF	T Max (C)	500
T Min (C)	20	PSOT max (bar)	23,47 BAR
PSOT min (bar)	137 BAR	NACE MR 0175	ASME B16.34
LVF SpA		- Italy -	



# GATE VALVES

GATE

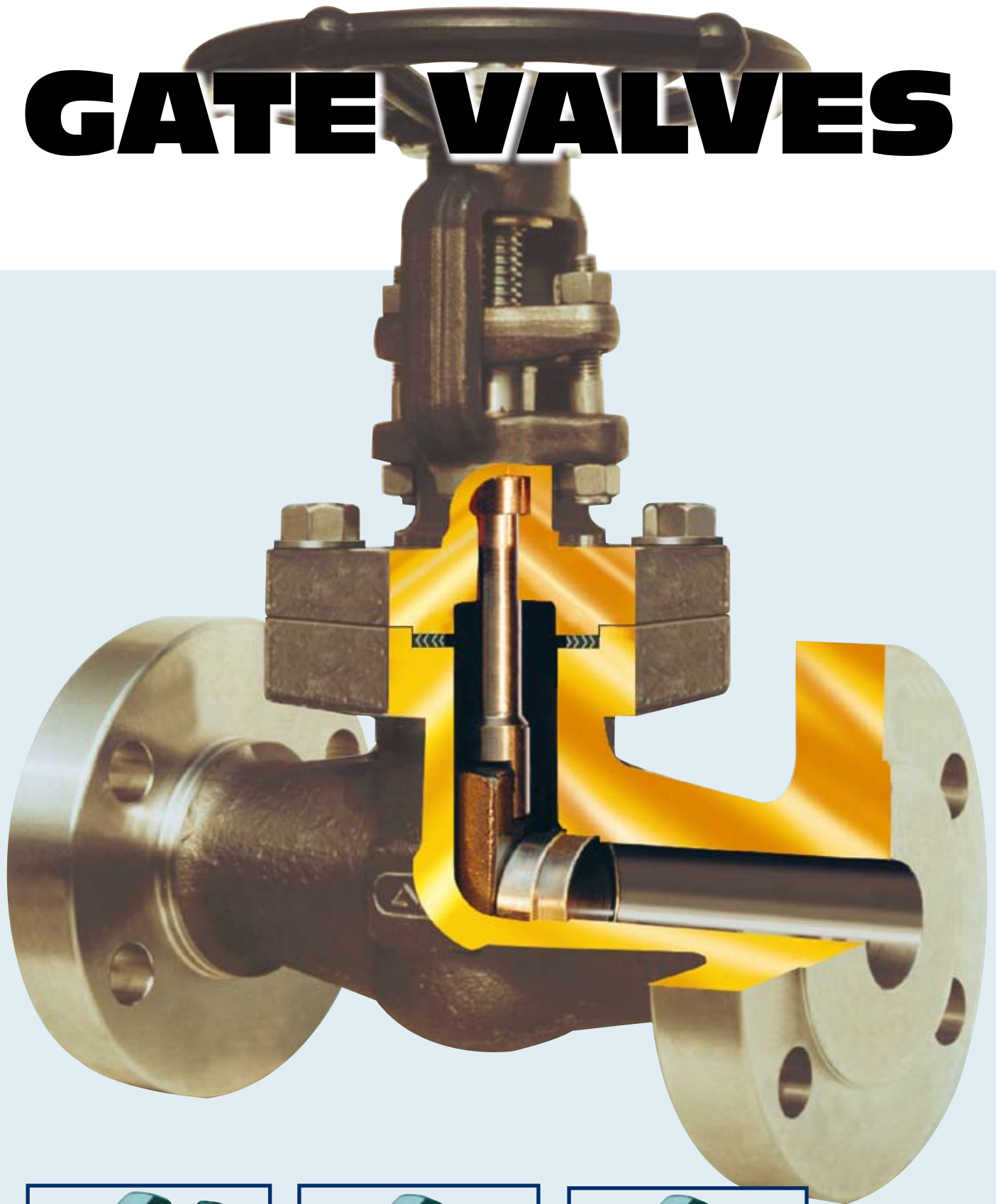

Standard wedge



Flexible wedge



Split wedge

# GATE



<b>Construction</b>	Bolted Bonnet, Welded Bonnet, Pressure Seal – Solid or Flex Wedge, Parallel Slide
<b>Main Design Codes</b>	ASME B16.34, API602, BS5352, ISO 15761, API 600, API 6A, API 603
<b>Pressure Class</b>	ANSI 150#-4500#
<b>Size range</b>	from ½" to 36"
<b>API 6A Pressure Clas</b>	3000-15000
<b>Ends</b>	SW, NPT, BW, RF, RJ, HUB, Compact Flange
<b>Main Materials</b>	Carbon Steel, Low temperature Carbon Steel , Stainless Steel, Duplex, Super Duplex, Low & High Alloy Steel, Titanium and any other special on request
<b>Alternative customized solutions can be provided including</b>	design for cryogenic service /bellow seal valves/integral extended bodies valves/DIN valves



## 150 BOLTED & WELDED BONNET - Standard bore Outside screw & yoke - Integral flanged ends

Standard bore Size	Fig. n° Bolted B.	Fig. n° Welded B.	A End to end	B Dia of port	C Centre to top	D Handwheel	Kg Weight
1/2	1B 103	1W 103	108	14	180	80	3,2
3/4	1B 104	1W 104	118	18	185	100	4,2
1	1B 105	1W 105	127	24	210	120	5,8
1¼	-	-	-	-	-	-	-
1½	1B 107	1W 107	165	36,5	270	140	11
2	1B 108	1W 108	178	48	300	170	16

## 150 BOLTED & WELDED BONNET - Reduced bore Outside screw & yoke - Integral flanged ends

Reduced bore Size	Fig. n° Bolted B.	Fig. n° Welded B.	A End to end	B Dia of port	C Centre to top	D Handwheel	Kg Weight
1/2	1BR 103	1WR 103	108	10	173	80	3,1
3/4	1BR 104	1WR 104	118	14	180	80	4
1	1BR 105	1WR 105	127	18	205	100	5,7
1¼	1BR 106	1WR 106	140	24	235	120	8,2
1½	1BR 107	1WR 107	165	30	260	140	10,6
2	1BR 108	1WR 108	178	36,5	296	170	15,4

## 300 BOLTED & WELDED BONNET - Standard bore Outside screw & yoke - Integral flanged ends

Standard bore Size	Fig. n° Bolted B.	Fig. n° Welded B.	A End to end	B Dia of port	C Centre to top	D Handwheel	Kg Weight
1/2	3B 103	3W 103	140	14	180	80	4,1
3/4	3B 104	3W 104	153	18	188	100	5,5
1	3B 105	3W 105	165	24	210	120	6,8
1¼	3B 106	3W 106	178	29	260	140	12,5
1½	3B 107	3W 107	191	36,5	270	170	13,5
2	3B 108	3W 108	216	48	312	170	17,5

## 300 BOLTED & WELDED BONNET - Reduced bore Outside screw & yoke - Integral flanged ends

Reduced bore Size	Fig. n° Bolted B.	Fig. n° Welded B.	A End to end	B Dia of port	C Centre to top	D Handwheel	Kg Weight
1/2	3BR 103	3WR 103	140	10	174	80	4
3/4	3BR 104	3WR 104	153	14	180	80	5,4
1	3BR 105	3WR 105	165	18	205	100	6,5
1¼	3BR 106	3WR 106	178	24	260	140	12,5
1½	3BR 107	3WR 107	191	30	265	140	13
2	3BR 108	3WR 108	216	36,5	296	170	17,5

## 600 BOLTED & WELDED BONNET - Standard bore Outside screw & yoke - Integral flanged ends

Standard bore Size	Fig. n° Bolted B.	Fig. n° Welded B.	A End to end	B Dia of port	C Centre to top	D Handwheel	Kg Weight
1/2	6B 103	6W 103	165	14	180	80	4,5
3/4	6B 104	6W 104	191	18	205	100	5,8
1	6B 105	6W 105	216	24	232	120	7,5
1¼	6B 106	6W 106	229	29	245	140	14,5
1½	6B 107	6W 107	241	36,5	278	140	16
2	6B 108	6W 108	292	48	327	170	23

## 600 BOLTED & WELDED BONNET - Reduced bore Outside screw & yoke - Integral flanged ends

Reduced bore Size	Fig. n° Bolted B.	Fig. n° Welded B.	A End to end	B Dia of port	C Centre to top	D Handwheel	Kg Weight
1/2	6BR 103	6WR 103	165	10	145	80	4,2
3/4	6BR 104	6WR 104	191	14	155	80	5,6
1	6BR 105	6WR 105	216	18	185	100	7,2
1¼	6BR 106	6WR 106	229	29	248	140	14,5
1½	6BR 107	6WR 107	241	30	248	140	14,5
2	6BR 108	6WR 108	292	36,5	273	170	18

## 1500 ROUND BOLTED & WELDED BONNET - Standard bore Outside screw & yoke - Integral flanged ends

Standard bore Size	Fig. n° Bolted B.	Fig. n° Welded B.	A End to end	B Dia of port	C Centre to top	D Handwheel	Kg Weight
1/2	15BF 103	15WF 103	216	14	210	100	10
3/4	15BF 104	15WF 104	229	18	255	120	15
1	15BF 105	15WF 105	254	24	275	140	17
1½	15BF 107	15WF 107	305	36,5	380	172	35
2	15BF 108	15WF 108	368	40	388	260	55
2S	15BF 108S	15WF 108S	368	48	468	260	70

## 2500 ROUND BOLTED & WELDED BONNET - Standard bore Outside screw & yoke - Integral flanged ends

Standard bore Size	Fig. n° Bolted B.	Fig. n° Welded B.	A End to end	B Dia of port	C Centre to top	D Handwheel	Kg Weight
1/2	25BF 103	25WF 103	264	14	250	120	14
3/4	25BF 104	25WF 104	273	14	255	120	16
1	25BF 105	25WF 105	308	18	270	140	25
1½	25BF 107	25WF 107	384	30	385	260	50
2	25BF 108	25WF 108	451	36,5	460	260	80

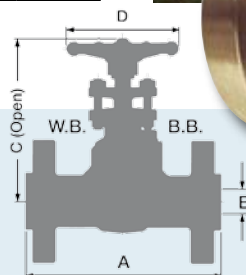

# OPTIONAL FEATURES

# ANSI

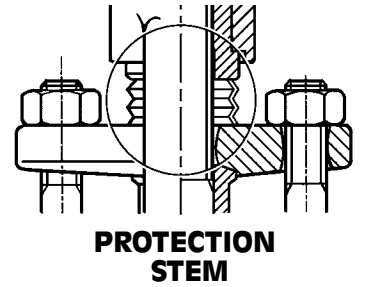
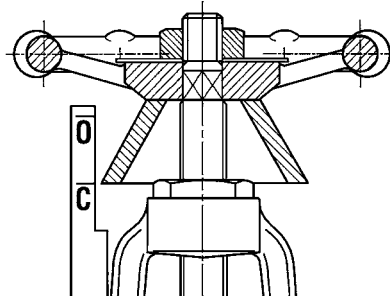
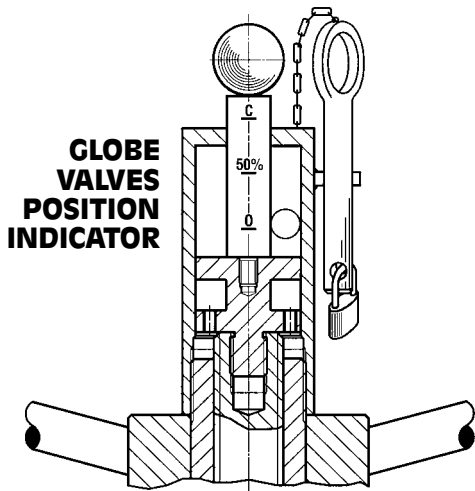

**GATE VALVES FLOW LIMIT CONTROL**

**PROTECTION STEM**

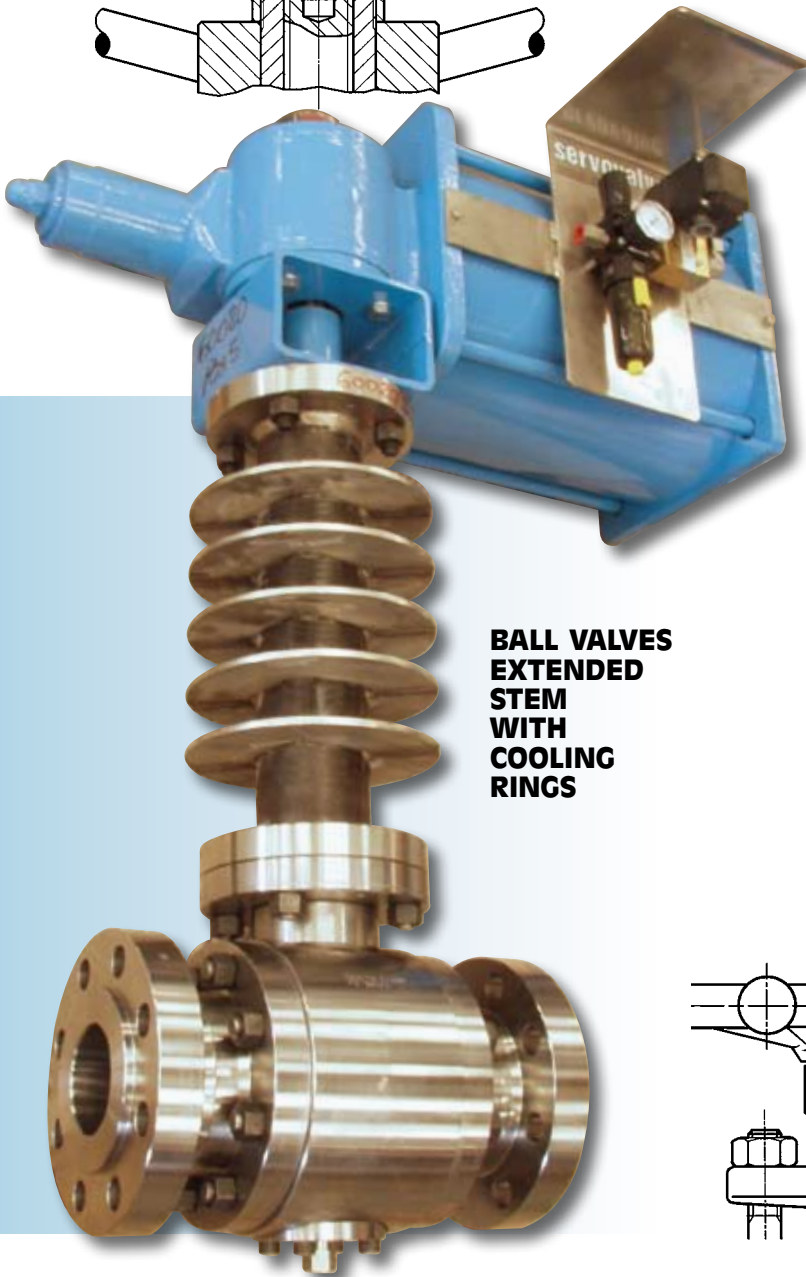

**BALL VALVES EXTENDED STEM WITH COOLING RINGS**

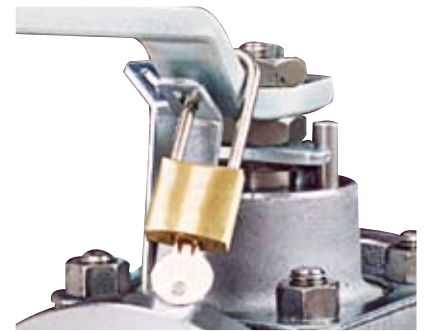
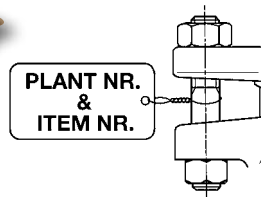

**BALL VALVES LEVER LOCKING DEVICE**

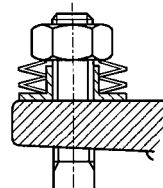

**SPRING LOADED PACKING DETAIL**

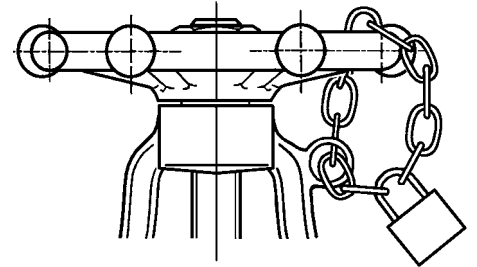

**VALVES HANDWHEEL LOCKING DEVICE**

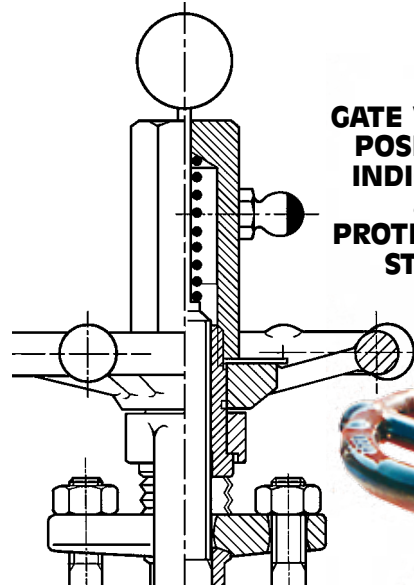

**GATE VALVES POSITION INDICATOR & PROTECTION STEM**

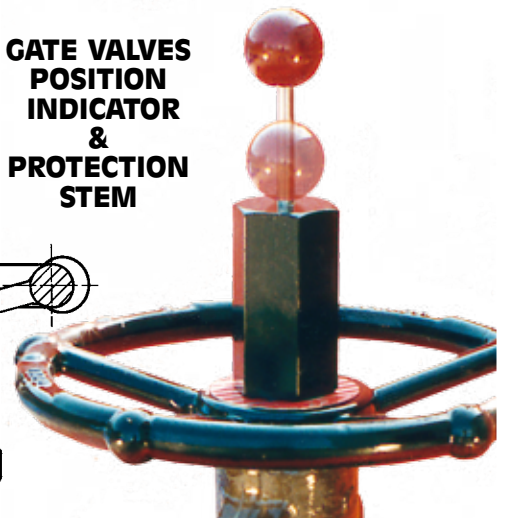

## BODY/BONNET LVF'S MATERIALS

MAT.	DESCRIPTION	SERVICE RECOMMENDATIONS	TEMPERATURE
A105	Carbon steel	General service: oil, oil vapor, gas, steam, water	-10 ÷ 540 °C
LF2	Low temp. Carbon steel	Low temperature applications	-46 ÷ 425 °C
LF3	Low temp. Carbon steel	Low temperature applications	-101 ÷ 345 °C
F11	1.25 Cr, 0.5 Mo alloy steel	To minimize graphitization	-29 ÷ 600 °C
F22	2.25 Cr, 1 Mo alloy steel	For service requiring greater strength than F11	-29 ÷ 600 °C
F5	5 Cr, 0.5 Mo alloy steel	Corrosive/erosive refinery use	-29 ÷ 600 °C
F9	9 Cr, 1 Mo alloy steel	For media with higher sulphur content	-29 ÷ 600 °C
F44	Austenitic stainless steel	Very high strength, high resistance to corrosion	-29 ÷ 400 °C
F304DG	18 Cr, 8 Ni stainless steel	Corrosive and cryogenic service	-29 ÷ 540 °C
F316 DG	18 Cr, 8 Ni, 2 Mo stainless steel	As F304 with superior resistance to corrosion	-29 ÷ 540 °C
F51, F53, F55	Ferritic-austenitic stainless steel	High strength, resistance to corrosion, pitting and stress corrosion in chloride media	-50 ÷ 315 °C
Titanium	Metal	Good resistance to corrosion with low weight	-60 ÷ 315 °C
Monel	Nickel-copper alloy	Resistant to corrosion, sea water, acids and alkalies	-196 ÷ 482 °C
Inconel Incoloy	Nickel alloy	Resistant to corrosion, nuclear application	High temp.
Hastelloy	Nickel alloy	Excellent corrosion resistance in hydrochloric acid	High temp.

## MAIN TRIM LVF'S MATERIALS

MAT.	DESCRIPTION	SERVICE RECOMMENDATIONS	TEMPERATURE
13Cr, F6	Stainless steel	General service: oil, oil vapor, gas, steam, water	High temp.
F304, F316	Austenitic stainless steel	Corrosive service	-29 ÷ 540 °C
Monel	Nickel-copper alloy	Corrosive service such as acids, alkalies salt solutions.	-196 ÷ 482 °C
Stellite	Hard facing overlay	Premium trim, suitable for sever service	≤ 649 °C

The most of the above material grades may be provided fully suitable for sour service as defined by NACE MR 0175 and MR 0103 standards.

## LVF VALVES CV FACTORS

The CV factors (US gallons per minute of water at 70°F flowing through the valve at a pressure drop of one p.s.i.) for standard design LVF valves are listed below.

These average values were obtained performing the test in our factory upon valves taken randomly. For valves not listed below CV values can be easily found when required.

Useful conversion formulas for liquid:

Flow rate (GPM):

K factor (flow resistance coefficient):

$$K = (29,9 \frac{d^2}{C_v})^2$$

Flow rate (GPM)

$$Q = (C_v \sqrt{\Delta p / S})$$

Pressure drop (p.s.i.):

$$\Delta p = S (Q / C_v)^2$$

where: d = internal diameter of pipe in which valve is to be installed (in);

S = specific gravity of liquid relative to water at 60°F.

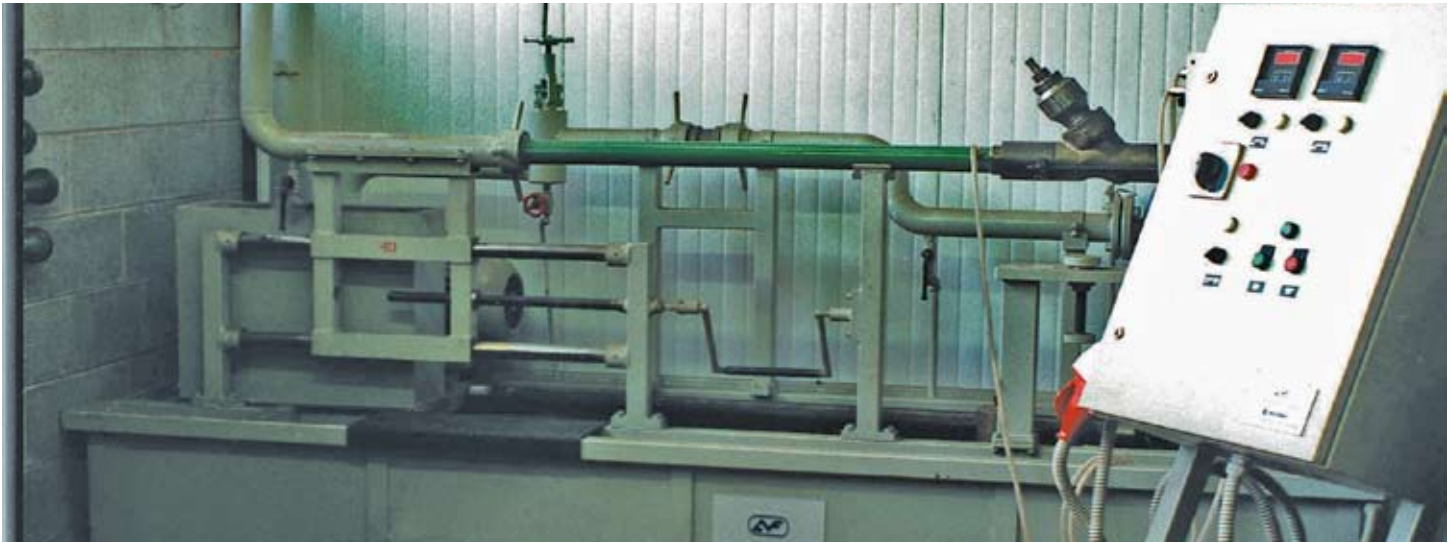

VALVE TYPE	RATING	BORE	SIZE							
			1/4"	3/8"	1/2"	3/4"	1"	1 1/4"	1 1/2"	2"
GATE .....	150 ÷ 800	FULL	2	4,8	12,3	23,2	43	57	98	200
GATE .....	150 ÷ 800	REDUCED			6	10	26	44	65	103
GATE .....	1500	FULL	2,1	5	12,5	23,7	44	59	100	*
GATE .....	1500	REDUCED			6,2	10,5	26,5	45	65,5	99
GATE .....	2500	FULL			5	12,1	23	42,5	56	97
GLOBE .....	150 ÷ 800	FULL	0,9	1,5	3,2	5,8	11,5	15,2	20,9	38,3
GLOBE .....	150 ÷ 800	REDUCED			1,5	3,7	6,4	10,4	17,8	21,5
GLOBE .....	1500	FULL			2,8	6	12		20	24
GLOBE .....	1500	REDUCED			1,7	2,9	5,8		15,5	19,8
GLOBE -Y PATTERN.....	800				5,5	11,8	22		48	69
GLOBE -Y PATTERN.....	1500				5,5	11,8	15,5		36	56
GLOBE -Y PATTERN.....	2500				3,5	6,5	11,8		24,5	45

Bores: \*40mm = >155 - \* 48mm = >200

The Cv Valve is affected by several factors (e.g. shape of piston / disc, presence of spring, profile of internal bore...)

- The data shown in the above table are therefore approximate. When the Cv value is critical for the process or when ever the exact value is required, it may be requested directly to LVF.
- Our technical department will also be pleased to provide you with the Cv values for any type of valves not covered by the above table.

LVF Reserves the right to make all necessary changes on its products, without notice.



## HEAD OFFICE AND PLANT

**LVF S.p.A.**

Via Giuseppe Mazzini, 6

24060 - San Paolo - d'Argon - (BG) ITALY

Phone: +39-035-4255211 - Telefax: +39-035-959210

E-mail: [info@lvf.it](mailto:info@lvf.it) - Web: [www.lvf.it](http://www.lvf.it)