

PacT Series

ComPacT

NSX & NSXm

Catalog 2021

Molded-Case Circuit Breakers
And Switch-Disconnectors
From 16 To 630 A - Up To 690 V





Green Premium™



More than 75% of our product sales offer superior transparency on the material content, regulatory information and environmental impact of our products:

- RoHS compliance
- REACH substance information
- Industry leading # of PEP's*
- Circularity instructions



Discover what we mean by green
Check your products!

The Green Premium program stands for our commitment to deliver customer valued sustainable performance. It has been upgraded with recognized environmental claims and extended to cover all offers including Products, Services and Solutions.

CO₂ and P&L impact through... Resource Performance

Green Premium brings improved resource efficiency throughout an asset's lifecycle. This includes efficient use of energy and natural resources, along with the minimization of CO₂ emissions.

Cost of ownership optimization through... Circular Performance

We're helping our customers optimize the total cost of ownership of their assets. To do this, we provide IoT-enabled solutions, as well as upgrade, repair, retrofit, and remanufacture services.

Peace of mind through... Well-being Performance

Green Premium products are RoHS and REACH compliant. We're going beyond regulatory compliance with step-by-step substitution of certain materials and substances from our products.

Improved sales through... Differentiation

Green Premium delivers strong value propositions through third-party labels and services. By collaborating with third-party organizations we can support our customers in meeting their sustainability goals such as green building certifications.

*PEP: Product Environmental Profile (i.e. Environmental Product Declaration)

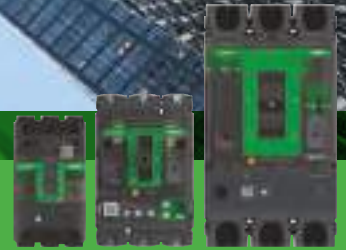

Meet the new face of connected breaker technology

Discover the New Generation of ComPacT

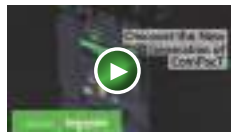

70 years of innovative and reliable protection

The Schneider Electric™ Com**PacT**™ range is built on 70 years of expertise and leadership in industrial circuit breakers.

Today Schneider Electric is launching its new generation of Com**PacT** molded case circuit breakers.

The comprehensive, optimized Com**PacT** range covers your protection and has been redesigned with a superior customer experience in mind.

The range combines wireless intelligent metering and monitoring, along with advanced protective functions.

This range can be connected to Schneider Electric's open, interoperable, IoT-enabled EcoStruxure™ Power architecture. Through this platform we deliver enhanced value in terms of safety, reliability, efficiency, sustainability, and connectivity.

We leverage technologies in IoT, mobility, sensing, cloud, analytics, and cybersecurity to deliver Innovation at Every Level. This includes connected products, edge control, apps, analytics and services.



se.com/compact-nsx

Life Is On



ComPacT NSX and NSXm, even more innovative and efficient

ComPacT circuit breakers feature Schneider Electric's exclusive Roto-Active Breaking System; it reduces the effects of short circuits of your installation.

Today, the ComPacT range is optimized with a high level of breaking capacities, outstanding selectivity and cascading. It offers more advanced functions and ergonomic designs for easy installation and operations.

Eleven Performance Levels

K | HB2 | HB1 | R | L | S | H | N | F | B | E

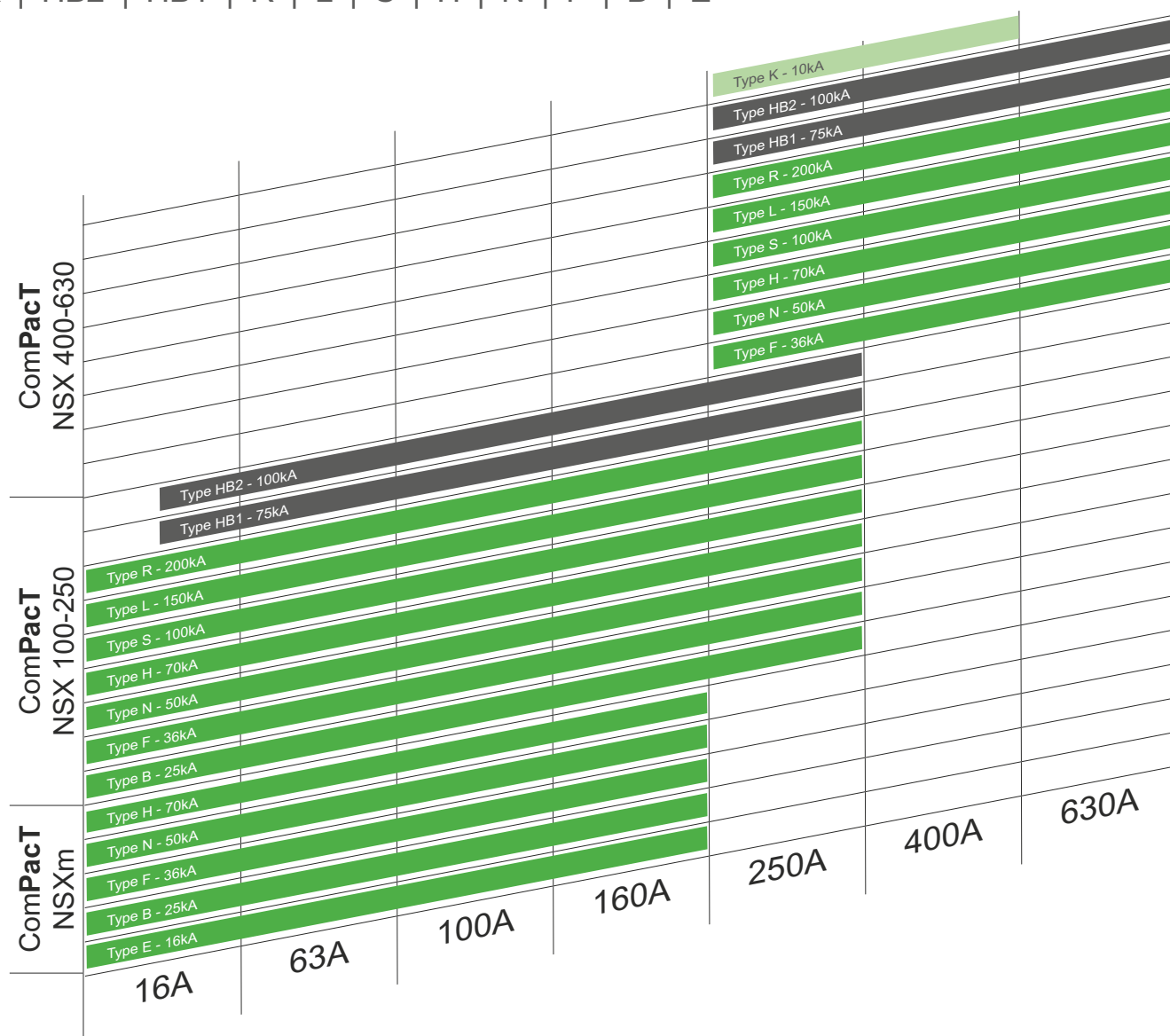

Icu = (kA rms) at 1000V AC
 Icu = (kA rms) at 690V AC
 Icu = (kA rms) at 415V AC

Schneider Electric is proud to introduce the new generation of ComPacT MCCBs. These breakers talk to you, wherever you are, in all transparency. New design complements new wireless connectivity capabilities with our latest wireless auxiliary contact.

New

ComPacT Design



New signature design

- Schneider Electric green signature style for the entire ComPacT range
- Estimated 40% reduction of wiring time for panel builders
- Experience easier installation thanks to a new ergonomic front-plate design
- Gain the confidence that all auxiliaries are on the right spot, and simply double check that you have the right coil rating
- Ergonomic new toggle for easier breaker manual operation

New

Wireless Auxiliary Contact



Wireless breaker status

- Plug & play technology for clear connection status (0 or 1, no half-way wired)
- Placed in the same position as the wired version, its LED light will give you direct indication in case of a tripping
- If you are away, your ComPacT will send you an immediate notification via EcoStruxure Facility Expert for instance
- Wireless auxiliary accelerates overall wiring time: status communication is done very simply and commissioned wirelessly
- Communication architecture is fully EcoStruxure Power validated, with any application

Ready to meet the new face of ComPacT?



In 2021 you will meet the new generation of ComPacT™ circuit breakers with semi-transparent faceplate, screwless auxiliaries and remote monitoring features.

Learn about the benefits of the ComPacT range here:
se.com/compact-nsx

While we are launching a new generation of ComPacT breakers, we are building upon the very latest innovations that made the success of the range in the first place. The following innovations were launched recently and are still very much applicable to the new generation of ComPacT breakers.

ComPacT NSXm



Smallest size in the range

- ComPacT NSXm is the smallest frame size in the range, incorporating new features and innovations
- Gain up to 40% in space when using with integrated earth leakage protection
- Reduce up to 40% mounting and cabling time with EverLink™ connectors, built-in DIN rail and spring-type auxiliaries
- Select, configure and commission with ease, thanks to Schneider Electric online tools: EcoStruxure Customer Lifecycle Software, such as EcoStruxure Power Design – Ecodial

MicroLogic Vigi



Integrated earth leakage protection

- Easy to integrate into a row that does not have earth leakage protection
- Simple to use, reliable, and now comes in the same frame size, and for the same panel support
- Gain up to 40% in space when using with integrated earth leakage protection into the MicroLogic Vigi trip units
- Standard protection of distribution cables
- Part of the EcoStruxure Power architecture, with digital communication capability and data management (settings, measurement, pre-alarms, trip & test history)

Innovation that protects:



In 2021 you will meet the new generation of ComPacT™ circuit breakers with semi-transparent faceplate, screwless auxiliaries and remote monitoring features.

Learn about the benefits of the ComPacT NSX range here:
se.com/compact-nsx

Optimized size and innovations tailored to your needs

Roto-active™ breaking technology

While the ComPacT NSXm is the smallest breaker in the ComPacT range, it nonetheless features all the innovations from previous generations, and notably includes roto-active breaking technology. Schneider Electric was the first to introduce this technology - an innovation in which the effective fault current limitation benefits the entire installation, particularly its cables.

Reduce the effects of short circuits to extend your installation life:

- Increase life duration of all items downstream of the electrical network
- Provide both outstanding selectivity and cascading



EverLink™ connectors – for enduring protection



ComPacT NSXm

The ComPacT NSXm features EverLink, an innovative cable connection method with patented creep-compensating technology that is built directly into the terminal. EverLink gives you:

- Confidence that your electrical connections maintain consistent pressure on the cable over time
- A space-saving solution as bare cable connections are as reliable as compression lug cable connections
- IP40 protection available thanks to transparent long terminal shield





Connectivity: from corrective to predictive maintenance

As Schneider Electric's IoT-connected power supply architecture, EcoStruxure Power makes maintenance more effective, and reduces the probability and duration of blackouts. ComPacT circuit breakers play a major role in the EcoStruxure architecture, acting as watchdogs over the power supply systems, and providing data to digital architectures and monitoring software.

Corrective maintenance

EcoStruxure Power enables maintenance managers to significantly reduce power outage duration.

Example: In case of a tripped breaker, the system automatically sends email alerts. Facility managers can diagnose the incident remotely, decide upon the appropriate actions, and monitor the results.

Preventative maintenance

Enables technicians to fix issues before impacting the comfort and productivity of building occupants. This is done by:

- Sending remote warnings as soon as a creeping fault is detected, especially current leakage.
- Assisting during routine checks, ensuring all points are verified regularly and providing access to all information, including event logs, in case of suspected weakness.

The available information enables preventive maintenance based on wear-out indications and warnings sent via the digital system.

Predictive maintenance

Data collected across the power distribution network, stored and computed by Schneider Electric analytics, provides greater insight for improved long-term planning and life-cycle management. Furthermore, advanced data processing enables predictive maintenance.

Example: By analyzing historical data and monitoring load profiles, maintenance and upgrades can be scheduled efficiently.



Learn about connectivity online:



Scan or click on QR code



EcoStruxure Power connected products

Embrace an open partner ecosystem

Today's value chain in electrical distribution is highly fragmented and inefficient from design to maintenance.

With EcoStruxure Power solutions, Schneider Electric strengthens and simplifies the entire project path by shaping a unique ecosystem of specifiers, contractors, panel builders, integrators, distributors and facility managers serving end users.

450,000+

EcoStruxure installations

1 billion

connected devices

For these electrical distribution professionals, EcoStruxure Power provides opportunities to broaden and improve the services they offer their customers.

- A comprehensive and innovative range of IoT-enabled LV and MV offers
- Proven, interoperable reference architectures for any building or business
- Design, selection, commissioning and configuration tools to enhance deployment efficiencies across the project life cycle

Apps, Analytics & Services



Actionable predictive maintenance information that helps protect your customers, safeguard your reputation and minimize financial impact.

Edge Control



Track maintenance activity to reduce downtime, energy use, and maintenance costs while improving site planning and revealing additional capacity.

Connected Products



IoT-enabled low and medium voltage offers to seamlessly fit into EcoStruxure architectures.

Contribute to a better world. Enhance sustainability with ComPacT range

Achieve Green Building certification with Green Premium ecolabel

In compliance with ISO 14025 PEP ecopassport program, we publish a comprehensive Life Cycle Analysis of our product, providing the environmental data you need to achieve Green Building certifications.

For example, ComPacT NSX & NSXm contribute to 3 LEED™ points in the Building Product Disclosure and Optimization section:

- Environmental Product Declaration
- Material Ingredients



ComPacT NSX range is now enriched with the new ComPacT NSXm, designed according to the EcoDesign Way™ by Schneider. It now features new space saving frame size for reduced resource consumption, and more.



New Packaging

- The ComPacT range comes in plastic-less packaging: not only to reduce our carbon footprint, but it also means less waste in the workshop
- Simplified instruction sheets included in all packaging
- 100% recycled carton
- Scan QR codes for access to digital documentation
- This product is REACH and RoHS compliant



New generation, simpler commercial references

New meaningful references to make your life easier

We know any change in commercial references will be an adjustment, but in the long run we believe this change is needed, and will make your life easier.

Type (1)	Frame rating (2)	Breaking capacity (1)	Num Poles (2)	Trip Unit (2)	Trip Unit Ratings (3)	Suffix (1)
NSX = C	100m = 11	16kA = E	1P = 1	TMD = TM	16 = 016	EverLink = L
NSXm = C	160m = 12	25kA = B	2P = 2	MA = MA	20 = 020	Busbar = B
	100 = 10	36kA = F	3P3D = 3	TMG = MG	25 = 025	Fixed = F
	160 = 16	50kA = N	4P4D = 4	1.3 M = 1M	30 = 030	DC = D
	250 = 25	70kA = H	3P2D = 5	2.2 = 2D	40 = 040	Switch = S
	400 = 40	100kA = S	4P3D = 6	2.3 = 2D	50 = 050	DC PV = DP
	630 = 63	150kA = L		4.1 = 4V	63 = 063	
		...		4.2 = 4V	80 = 080	Acc with ID
				...	100 = 100	change = T
					...	

For instance LV429630 will become C10F3TM100
Com**PacT** Breaker NSX100F 36kA AC 3P3D 100A TMD

Scan QR code for breaker updates

Each breaker is equipped with a QR code that allows you to get the latest information on your breaker.



Simpler names for our offers

We are making it easier for you to navigate across the wide range of our world-class digital offerings and select with confidence the offers that are right for you and your needs.

EcoStruxure Architecture

To enable brand consistency, relevance and impact, we are reinforcing our EcoStruxure™ architecture and digital customer lifecycle tools to ensure a seamless experience from the CAPEX to OPEX phases of each project, bridging our entire ecosystem of partners, services providers and end users.

EcoStruxure is our IoT-enabled open and interoperable system architecture and platform. EcoStruxure delivers enhanced values around safety, reliability, efficiency, sustainability and connectivity for our customers. EcoStruxure leverages advancements in IoT, mobility, sensing, cloud, analytics, and cybersecurity technologies to deliver Innovation At Every Level from Connected Products; Edge Control; and Apps, Analytics & Services: our IoT technology Levels.

Old names	New names
Ecodial	EcoStruxure Power Design
Ecoreal	EcoStruxure Power Build
Ecoreach	EcoStruxure Power Commission
Masterpact MTZ mobile App	EcoStruxure Power Device App

Pact Series

Future-proof your installation with Schneider Electric's low and medium voltage **Pact** Series. Built on legendary Schneider Electric innovation, the **Pact** Series comprises world-class circuit breakers, switches, residual current devices and fuses, for all standard and specific applications. Experience robust performance with this comprehensive range of EcoStruxure- ready switchgear, for all applications from 16 to 6300 A.

Old names	New names
Compact	Com Pact
Masterpact	Master Pact
Micrologic	Micro Logic
Transferpact	Transfer Pact
Fupact	Fu Pact

General contents

ComPacT NSXm & NSX

Presentation

Select Circuit Breakers and Switch-Disconnectors

Select Protection

Customize Circuit Breakers with Accessories

Smart Panel Integration

Switchboard Integration

Catalog Numbers

Glossary

Additional Characteristics

A

B

C

D

E

F

G

H

ComPacT NSXm & NSX Application Overview

The ComPacT NSX and NSXm circuit breakers and switch-disconnectors are the best choice for all standards and specific applications.

ComPacT for Fire
Prevention in 60 Seconds



ComPacT for Power
Availability in 60 Seconds



> Compact Switch-Disconnectors
INS-INV40 to 2500 A Catalog [a]



LVPED213024EN

> FuPacT [a]



LVPED216031EN

> Substitution and Technical Guide
ComPacT NSX High Performance [b]



LVPED221004EN

> ComPacT NSX, ComPacT INS/INV,
MasterPact NW DC - DC PV - DC EP [c]



LVPED221002EN

> TransferPacT
(Source-changeover systems) [d]



LVPED216028EN

> Selectivity, Cascading and
Coordination Guide, Complementary
Technical Information



LVPED318033EN

ComPacT NSXm & NSX

Application Overview

Buildings

ComPacT NSXm devices up to 160 A (70 kA/415 V) are equipped with thermal magnetic trip units.

ComPacT NSX devices up to 630A (200 kA/415 V) are equipped with Magnetic, Thermal Magnetic, basic electronic trip units (MicroLogic 2) and advanced electronic trip units (MicroLogic 5/6) which offer embedded metering and communication.

Both devices can protect against insulation faults thanks to their embedded earth leakage protection.

ComPacT NSXm and NSX can be easily installed at all levels in distribution systems, from main LV switchboard to the subdistribution boards and enclosures.

Industrial Buildings, Machines, Ventilation and Water Treatment

The ComPacT NSX range includes a number of versions to protect motor applications:

- Basic short-circuit protection with MA magnetic trip units or the electronic MicroLogic 1-M version, combined with an external relay to provide thermal protection.
- Protection against overloads, short-circuits with additional motor-specific protection (phase unbalance, locked rotor, underload and long start) with MicroLogic 6 E-M trip units.

These versions also offer communication, metering and operating assistance.

The exceptional limiting capacity of ComPacT NSX circuit breakers automatically provides type-2 coordination with the motor starter, in compliance with standard IEC 60947-4-1.

Buildings and Industrial Buildings

A switch-disconnector version of ComPacT NSXm and NSX circuit breakers is available for circuit control and isolation. All add-on functions of both circuit breakers may be combine with the basic switch-disconnector function.

For information on other switch-disconnector ranges, see the ComPacT INS/INV catalog and for fusegear protection see FuPacT catalog [a].

Marine

ComPacT NSX HB1/HB2 up to 630 A circuit breakers have the best-in-class breaking capacity for Marine applications (100 kA/690 V).

Devices can be equipped with thermal magnetic, basic electronic trip units (MicroLogic 2) and advanced electronic trip units (MicroLogic 5/6) which offer embedded metering and communication.

Standard ComPacT NSX breakers AC and DC ranges can be used for military navy inside the main and emergency switchboards [b].

Special Applications

The ComPacT NSX range offers a number of versions for special protection applications:

- Service connection to public distribution systems
- Generators
- Industrial control panels
- 16 Hz 2/3 systems
- 400 Hz systems [1]

For all these applications, circuit breakers in the ComPacT NSX range offer positive contact indication and are suitable for isolation in accordance with standards IEC 60947-1 and 2.

[1] ComPacT NSXm may be used on 400 Hz systems.

Photovoltaic

ComPacT NSX DC PV range up to 500 A (1000V DC), and range from 250 A to 400 A (800 to 1000 V AC), equipped with electronic trip unit MicroLogic 2 is the appropriate choice for photovoltaic generation from 10 kW to 500 kW.

Circuit breakers can be used for over-current protection.

Circuit breakers and switches can be used for isolation during maintenance phase.

ComPacT NSX is part of a Schneider Electric photovoltaic architecture which offers AC and DC protection, control and metering, inverters for DC to AC voltages and PV modules [c].

Oil and Gas

ComPacT NSX up to 630 A offers the Highest breaking capacity in its class mainly required in Oil and Gas industry:

- Up to 100 kA at 690 V
- Up to 200 kA at 415 V

Devices can be equipped with thermal magnetic, basic electronic trip units (MicroLogic 2) and advanced electronic trip units (MicroLogic 5/6) which offer embedded metering and communication

ComPacT NSX range offers outstanding selectivity at 415 V and 690 V [b].

Critical Power Supplies

ComPacT NSX DC range up to 1200 A (5 kA/600 V DC) meets the requirements of UPS manufacturers keeping the same compact footprint as the standard ComPacT NSX range.

Batteries are usually used for emergency power supply and circuit breakers are used to protect the battery circuit (between the battery and the circuit) [c].

To allow a continuous supply of power, some electrical installations are connected to two power sources [d]:

- A normal source.
- A replacement source to supply the installation when the normal source is not available.

A mechanical and/or electrical interlocking system between two circuit breakers or switch-disconnectors avoids all risk of parallel connection of the sources during switching.

A source-changeover system can be:

- Manual with mechanical device interlocking
- Remote controlled with mechanical and/or electrical device interlocking
- Automatic by adding a controller to manage switching from one source to the other on the basis of external parameters.



Select Circuit Breakers and Switch-Disconnectors

Characteristics and Performance

- ComPacT NSXm Circuit Breakers from 16 to 160 A up to 690 V... A-2
- ComPacT NSX Circuit Breakers from 100 to 250 A up to 690 V.... A-4
- ComPacT NSX Circuit Breakers from 400 to 630 A up to 690 V.... A-8
- ComPacT NSXm Switch-Disconnectors from 50 to 160 A NA..... A-10
- ComPacT NSX Switch-Disconnectors from 100 to 630 A NA..... A-12

General Characteristics of the ComPacT Range

ComPacT NSX Special Applications

- High Performance at 690 V A-16



Other Chapters

- Select Protection B-1
- Customize Circuit Breakers with Accessories..... C-1
- Smart Panel Integration D-1
- Switchboard Integration..... E-1
- Catalog Numbers F-1
- Glossary G-1
- Additional Characteristics..... H-1

Characteristics and Performance

ComPacT NSXm Circuit Breakers from 16 to 160 A up to 690 V

ComPacT New Generation Overview



A

C12H3TM160LL-eps



ComPacT NSXm

Common Characteristics

Rated voltages	Insulation voltage (V)	Ui	800
	Insulation voltage for ELCB [1] (V)	Ui	500
	Impulse withstand voltage (kV)	Uimp	8
	Operational voltage (V)	Ue AC 50/60 Hz	690
	Operational voltage for ELCB [1] (V)	Ue AC 50/60 Hz	440
Suitability for isolation	IEC/EN 60947-2		yes
Utilization category			A
Pollution degree	IEC 60664-1		3

Circuit Breakers

Breaking Capacity Levels

Electrical characteristics as per IEC/EN 60947-2

Rated current (A)	In	40 °C
Number of poles		

Breaking capacity (kA rms)

Icu	AC 50/60 Hz	220...240 V
		380...415 V
		440 V
		500 V
		525 V
		660...690 V

Service breaking capacity (kA rms)

Ics	AC 50/60 Hz	220...240 V
		380...415 V
		440 V
		500 V
		525 V
		660...690 V

Durability (C-O cycles)	Mechanical		
		Electrical	440 V
		690 V	In/2

Protection and Measurements

Overload/short-circuit protection	Thermal magnetic
	Electronic with Earth Leakage Protection (ELCB)
Options	Device status/control
	For ELCB [1]: alarming and fault differentiation

Installation/Connections

Dimensions and weights

Dimensions (mm)	W x H x D	3P
		4P
Weight (kg)		ELCB [1]
		3P
		4P
		ELCB [1]

Connections

Pitch (mm)	Standard	
	With spreaders	
EverLink lug Cu or Al [2] cables	Cross-section (mm²)	Rigid
		Flexible
Crimp lugs Cu or Al	Cross-section (mm²)	Rigid
		Flexible

Source Changeover System

Manual mechanical interlocking

[1] ELCB: Earth Leakage Circuit Breaker (MicroLogic Vigi 4.1).

[2] Al up to 100 A.

Characteristics and Performance

ComPacT NSXm Circuit Breakers from 16 to 160 A up to 690 V



Common Characteristics

Control	Manual	With toggle	<input checked="" type="radio"/>
		With direct or extended rotary handle	<input checked="" type="radio"/>
		With side rotary handle	<input checked="" type="radio"/>
Versions	Fixed		<input checked="" type="radio"/>

NSXm up to 63 A						NSXm from 80 to 160 A and ELCB [1]				
E	B	F	N	H		E	B	F	N	H
63 3P, 4P						160 3P, 4P				
25	50	85	90	100		25	50	85	90	100
16	25	36	50	70		16	25	36	50	70
10	20	35	50	65		10	20	35	50	65
8	10	15	25	30		-	-	-	-	-
-	-	10	15	22		-	-	-	-	-
-	-	-	10	10		-	-	-	-	-
25	50	85	90	100		25	50	85	90	100
16	25	36	50	70		16	25	36	50	70
10	20	30	50	65		10	20	30	50	65
8	10	10	25	30		-	-	-	-	-
-	-	10	15	22		-	-	-	-	-
-	-	-	2.5	2.5		-	-	-	-	-
20000										
20000										
10000										
10000										
5000										
<input checked="" type="radio"/>						<input checked="" type="radio"/>				
<input checked="" type="radio"/>						<input checked="" type="radio"/>				
<input checked="" type="radio"/>										
81 x 137 x 80										
108 x 137 x 80										
108 x 144 x 80										
1.06										
1.42										
1.63										
27										
35										
95										
70										
120										
95										
<input checked="" type="radio"/>						<input checked="" type="radio"/>				

Characteristics and Performance

ComPacT NSX Circuit Breakers from 100 to 250 A up to 690 V

A



ComPacT NSX single-pole



ComPacT NSX two-pole

ComPacT Circuit Breakers

Number of poles		
Control	Manual	toggle
		direct or extended rotary handle
Connections	Electric	front connection
		rear connection
	Fixed	front connection
		rear connection
Withdrawable	front connection	
	rear connection	

Electrical Characteristics IEC/EN 60947-2

Rated current (A)	In	40 °C
Rated insulation voltage (V)	Ui	
Rated impulse withstand voltage (kV)	Uimp	
Rated operational voltage (V)	Ue	AC 50/60 Hz DC

Type of Circuit Breaker

Ultimate breaking capacity (kA rms)	Icu	AC	220/240 V	
			50/60 Hz	380/415 V
				440 V
				500/525 V
				660/690 V
DC	250 V (1P)			
	500 V (2P)			

Service breaking capacity (kA rms)	Ics	% Icu
Suitability for isolation		

Utilization category			
Durability (C-O cycles)	Mechanical		
	Electrical	277 V	In/2 In

Protection and Measurements

Type of trip units		
Ratings		In Ir
Overload protection (thermal)	Long time threshold	
Short-circuit protection (magnetic)	Instantaneous pickup	Ii value indicated for AC ^[1] real value for DC
Add-on earth-leakage protection	VigiPacT add-on combination with VigiPacT relay	

Additional Indication and Control Auxiliaries

Indication contacts	
Voltage releases	MX shunt release
	MN undervoltage release

Installation

Accessories	Terminal extensions and spreaders
	Terminal shields and interphase barriers
	Escutcheons
Dimensions (mm)	W x H x D
Weight (kg)	

Source Changeover System

Manual mechanical interlocking

[1] The thresholds for TMD and TMG 1-pole and 2-pole magnetic trip units up to 63 A are indicated for AC. The real DC thresholds are indicated on the following line.

Characteristics and Performance

ComPacT NSX Circuit Breakers from 100 to 250 A up to 690 V

NSX100					NSX160					NSX250				
1				2	1				2	1				
⊙				⊙	⊙				⊙	⊙				
-				-	-				-	-				
-				-	-				-	-				
⊙				⊙	⊙				⊙	⊙				
⊙				⊙	⊙				⊙	⊙				
-				-	-				-	-				
-				-	-				-	-				
100				100	160				160	250				
750				750	750				750	750				
8				8	8				8	8				
277				690	277				690	277				
250				500	250				500	-				
F	N	M		F	M	S		F	M	S	N			
18	25	40		36	85	100		18	25	40	25			
-	-	-		18	25	70		-	-	-	-			
-	-	-		15	25	65		-	-	-	-			
-	-	-		10	18	35		-	-	-	-			
-	-	-		5	8	10		-	-	-	-			
36	50	85		36	85	100		36	85	100	-			
-	-	-		36	85	100		-	-	-	-			
100 %				100 %				100 %			100 %			
⊙				⊙				⊙			⊙			
A				A				A			A			
20000				20000				20000			10000			
20000				20000				20000			10000			
10000				10000				10000			5000			
built-in thermal-magnetic					built-in thermal-magnetic					built-in thermal-magnetic				
16	20	25	30	40	50	63	80	100	125	160		160	200	250
fixed					fixed				fixed			fixed		
16	20	25	30	40	50	63	80	100	125	160		160	200	250
fixed					fixed				fixed			fixed		
190	190	300	300	500	500	500	640	800	1000	1250		850	850	850
260	260	400	400	700	700	700	800	1000	1200	1250		-	-	-
-				-	-				-			-		
-				⊙	-				-			⊙		
-				⊙	-				-			⊙		
-				⊙	-				-			⊙		
⊙				⊙	⊙				⊙			⊙		
⊙				⊙	⊙				⊙			⊙		
⊙				⊙	⊙				⊙			⊙		
35 x 161 x 86				70 x 161 x 86				35 x 161 x 86				70 x 161 x 86		35 x 161 x 86
0.7				1.2				0.7				1.2		0.7
⊙				⊙	⊙			⊙	⊙			⊙		⊙



Characteristics and Performance

ComPacT NSX Circuit Breakers from 100 to 250 A up to 690 V

ComPacT New Generation Overview



A



ComPacT NSX250 HB2

C25V05E250.aps

Common Characteristics

Rated voltages	Insulation voltage (V)	Ui	800
	Insulation voltage for ELCB [6]	Ui	500
	Impulse withstand voltage (kV)	Uimp	8
	Operational voltage (V)	Ue	AC 50/60 Hz 690
	Operation voltage for ELCB [6]	Ue	AC 50/60 Hz 440
Suitability for isolation		IEC/EN 60947-2	yes
Utilization category			A
Pollution degree		IEC 60664-1	3

Circuit Breakers

Breaking Capacity Levels

Electrical characteristics as per IEC/EN 60947-2

Rated current (A)	In	40 °C
-------------------	----	-------

Number of poles

Breaking capacity (kA rms)

Icu	AC 50/60 Hz	220/240 V
		380/415 V
		440 V
		500 V
		525 V
		660/690 V

Service breaking capacity (kA rms)

Ics	AC 50/60 Hz	220/240 V
		380/415 V
		440 V
		500 V
		525 V
		660/690 V

Durability (C-O cycles)	Mechanical		
		Electrical	440 V
		690 V	In/2
			In

Characteristics as per UL 60947-1

Breaking capacity (kA rms)	AC 50/60 Hz	240 V
		480 V
		600 V

Protection and Measurements

Short-circuit protection	Magnetic only
Overload/short-circuit protection	Thermal magnetic
	Electronic
	With neutral protection (Off-0.5-1-OSN) [1]
	With ground-fault protection
	With zone selective interlocking (ZSI) [2]

Display/I, U, f, P, E, THD measurements/interrupted-current measurement

Options	Power meter display on door
	Operating assistance
	Counters
	Histories and alarms
	Metering Com
	Device status/control Com

Earth-leakage protection	By VigiPacT add-on [3]
	By VigiPacT relay

Installation/Connections

Dimensions and weights

Dimensions (mm)	Fixed, front connections	2/3P
	W x H x D	4P
Weight (kg)	Fixed, front connections	2/3P
		4P

Connections

Connection terminals	Pitch	With/without spreaders
Large Cu or Al cables	Cross-section	mm ²

Source-Changeover System

Manual mechanical interlocking
Automatic source-changeover

[1] OSN: Over Sized Neutral protection for neutrals carrying high currents (e.g. 3rd harmonics).

[2] ZSI: Zone Selective Interlocking using pilot wires.

[3] VigiPacT add-on is not available for breaking capacity levels HB1/HB2.

[4] There is no 160 A frame, use 250 A frame with lower rating trip units for R, HB1, HB2.

[5] 2P circuit breaker in 3P case for B and F types, only with thermal-magnetic trip unit.

[6] Earth Leakage Circuit Breaker (MicroLogic Vigi 4.2 and 7.2 E).

Characteristics and Performance

ComPacT NSX Circuit Breakers from 100 to 250 A up to 690 V



Common Characteristics

Control	Manual	With toggle	<input type="radio"/>
		With direct or extended rotary handle	<input type="radio"/>
Versions	Electrical	With remote control	<input type="radio"/>
	Fixed		<input type="radio"/>
	Withdrawable	Plug-in base	<input type="radio"/>
		Chassis	<input type="radio"/>

NSX100									NSX160 ^[4]									NSX250								
B	F	N	H	S	L	R	HB1	HB2	B	F	N	H	S	L	R	HB1	HB2	B	F	N	H	S	L	R	HB1	HB2

100									160									250								
2 ^[5] , 3, 4									3, 4									2 ^[5] , 3, 4								

40	85	90	100	120	150	200	-	-	40	85	90	100	120	150	200	-	-	40	85	90	100	120	150	200	-	-
25	36	50	70	100	150	200	-	-	25	36	50	70	100	150	200	-	-	25	36	50	70	100	150	200	-	-
20	35	50	65	90	130	200	-	-	20	35	50	65	90	130	200	-	-	20	35	50	65	90	130	200	-	-
15	25	36	50	65	70	80	85	100	15	30	36	50	65	70	80	85	100	15	30	36	50	65	70	80	85	100
-	22	35	35	40	50	65	80	100	-	22	35	35	40	50	65	80	100	-	22	35	35	40	50	65	80	100
-	8	10	10	15	20	45	75	100	-	8	10	10	15	20	45	75	100	-	8	10	10	15	20	45	75	100

40	85	90	100	120	150	200	-	-	40	85	90	100	120	150	200	-	-	40	85	90	100	120	150	200	-	-
25	36	50	70	100	150	200	-	-	25	36	50	70	100	150	200	-	-	25	36	50	70	100	150	200	-	-
20	35	50	65	90	130	200	-	-	20	35	50	65	90	130	200	-	-	20	35	50	65	90	130	200	-	-
7	12	36	50	65	70	80	85	100	15	30	36	50	50	50	15	30	36	50	65	70	80	85	100			
-	11	35	35	40	50	65	80	100	-	22	35	35	35	35	-	22	35	35	40	50	65	80	100			
-	4	10	10	10	10	45	75	100	-	8	10	10	10	10	-	8	10	10	10	10	10	45	75	100		
50000						20000			40000						20000							20000				
50000						20000			40000						20000							20000				
30000						10000			20000						10000							10000				
20000						10000			15000						10000							10000				
10000						5000			7500						5000							5000				

-	85	85	85	-	-	-	-	-	-	85	85	85	-	-	-	-	-	-	85	85	85	-	-	-	-	-
-	25	50	65	-	-	-	-	-	-	35	50	65	-	-	-	-	-	-	35	50	65	-	-	-	-	-
-	10	10	10	-	-	-	-	-	-	10	10	10	-	-	-	-	-	-	15	15	15	-	-	-	-	-

<input type="radio"/>								
<input type="radio"/>								
<input type="radio"/>								
<input type="radio"/>								
<input type="radio"/>								
<input type="radio"/>								
<input type="radio"/>								
<input type="radio"/>								
<input type="radio"/>								
<input type="radio"/>								
<input type="radio"/>								
<input type="radio"/>								
<input type="radio"/>								
<input type="radio"/>								
<input type="radio"/>								
<input type="radio"/>								
<input type="radio"/>								
<input type="radio"/>								
<input type="radio"/>								
<input type="radio"/>								

105 x 161 x 86	105 x 161 x 86	105 x 161 x 86	105 x 161 x 86
140 x 161 x 86	140 x 161 x 86	140 x 161 x 86	140 x 161 x 86
2.05	2.4	2.2	2.4
2.4	2.8	2.6	2.8
35/45 mm 300	35/45 mm 300	35/45 mm 300	35/45 mm 300

<input type="radio"/>			
<input type="radio"/>			

Characteristics and Performance

ComPacT NSX Circuit Breakers from 400 to 630 A up to 690 V

C83V03BME630.eps



ComPacT NSX630 HB2

A

Common Characteristics

Rated voltages	Insulation voltage (V)	Ui	800
	Insulation voltage for ELCB [4]		500
	Impulse withstand voltage (kV)	Uimp	8
	Operational voltage (V)	Ue AC 50/60 Hz	690
	Operation voltage for ELCB [4]	Ue AC 50/60 Hz	440
Suitability for isolation		IEC/EN 60947-2	yes
Utilization category			A
Pollution degree		IEC 60664-1	3

Circuit Breakers

Breaking Capacity Levels

Electrical characteristics as per IEC/EN 60947-2

Rated current (A)	In	40 °C
-------------------	----	-------

Number of poles

Breaking capacity (kA rms)

Icu	AC 50/60 Hz	220/240 V
		380/415 V
		440 V
		500 V
		525 V
		660/690 V

Service breaking capacity (kA rms)

Ics	AC 50/60 Hz	220/240 V
		380/415 V
		440 V
		500 V
		525 V
		660/690 V

Durability (C-O cycles)

Mechanical	440 V	In/2
		In
		690 V
In		

Characteristics as per UL 60947-1

Breaking capacity (kA rms)	AC 50/60 Hz	240 V
		480 V
		600 V

Protection and Measurements

Short-circuit protection	Magnetic only
Overload/short-circuit protection	Thermal magnetic
	Electronic
	With neutral protection (Off-0.5-1-OSN) [1]
	With ground-fault protection
	With zone selective interlocking (ZSI) [2]

Display/I, U, f, P, E, THD measurements/interrupted-current measurement

Options	Power meter display on door
	Operating assistance
	Counters
	Histories and alarms
	Metering Com
	Device status/control Com

Earth-leakage protection	By VigiPacT add-on [3]
	By VigiPacT relay

Installation/Connections

Dimensions and weights

Dimensions (mm) W x H x D	Fixed, front connections	2/3P
		4P
Weight (kg)	Fixed, front connections	2/3P
		4P

Connections

Connection terminals	Pitch	With/without spreaders
Large Cu or Al cables	Cross-section	mm ²

Source-Changeover System

Manual mechanical interlocking

Automatic source-changeover

[1] OSN: Over Sized Neutral protection for neutrals carrying high currents (e.g. 3rd harmonics).

[2] ZSI: Zone Selective Interlocking using pilot wires.

[3] VigiPacT add-on is not available for breaking capacity levels HB1/HB2.

[4] Earth Leakage Circuit Breaker (MicroLogic Vigi 4.3 and 7.3 E)

Characteristics and Performance

ComPacT NSX Circuit Breakers from 400 to 630 A up to 690 V



Common Characteristics

Control	Manual	With toggle	<input type="radio"/>
		With direct or extended rotary handle	<input type="radio"/>
Versions	Electrical	With remote control	<input type="radio"/>
	Fixed		<input type="radio"/>
	Withdrawable	Plug-in base	<input type="radio"/>
		Chassis	<input type="radio"/>

NSX400									NSX630								
--------	--	--	--	--	--	--	--	--	--------	--	--	--	--	--	--	--	--

									I _r = 225 - 500 A			I _r = 501 - 630 A								
F	N	H	S	L	R	HB1	HB2		F	N	H	S	L	R	HB1	HB2	R	HB1	HB2	
400					400				630					630						
3, 4					3, 4				3, 4					3, 4						
40	85	100	120	150	200	-	-		40	85	100	120	150	200	-	-	200	-	-	
36	50	70	100	150	200	-	-		36	50	70	100	150	200	-	-	200	-	-	
30	42	65	90	130	200	-	-		30	42	65	90	130	200	-	-	200	-	-	
25	30	50	65	70	80	85	100		25	30	50	65	70	80	85	100	80	85	100	
20	22	35	40	50	65	80	100		20	22	35	40	50	65	80	100	65	80	100	
10	10	20	25	35	45	75	100		10	10	20	25	35	45	75	100	45	75	100	
40	85	100	120	150	200	-	-		40	85	100	120	150	200	-	-	200	-	-	
36	50	70	100	150	200	-	-		36	50	70	100	150	200	-	-	200	-	-	
30	42	65	90	130	200	-	-		30	42	65	90	130	200	-	-	200	-	-	
25	30	50	65	70	80	85	100		25	30	50	65	70	80	85	100	80	85	100	
10	11	11	12	12	65	80	100		10	11	11	12	12	65	80	100	-	-	-	
10	10	10	12	12	45	75	100		10	10	10	12	12	45	75	100	-	-	-	
15000					15000				15000					15000						
12000					12000				8000					8000						
6000					6000				4000					4000						
6000					6000				6000					6000						
3000					3000				2000					2000						
85	85	85	-	-	-	-	-		85	85	85	-	-	-	-	-	-	-	-	-
35	50	65	-	-	-	-	-		35	50	65	-	-	-	-	-	-	-	-	-
20	10	20	-	-	-	-	-		20	20	20	-	-	-	-	-	-	-	-	-

<input type="radio"/>	<input type="radio"/>
-	-
<input type="radio"/>	<input type="radio"/>
<input type="radio"/>	<input type="radio"/>
<input type="radio"/>	<input type="radio"/>
<input type="radio"/>	<input type="radio"/>
<input type="radio"/>	<input type="radio"/>
<input type="radio"/>	<input type="radio"/>
<input type="radio"/>	<input type="radio"/>
<input type="radio"/>	<input type="radio"/>
<input type="radio"/>	<input type="radio"/>
<input type="radio"/>	<input type="radio"/>
<input type="radio"/>	<input type="radio"/>
<input type="radio"/>	<input type="radio"/>
<input type="radio"/>	<input type="radio"/>
<input type="radio"/>	<input type="radio"/>
<input type="radio"/>	<input type="radio"/>
<input type="radio"/>	<input type="radio"/>
<input type="radio"/>	<input type="radio"/>

140 x 255 x 110	140 x 255 x 110
185 x 255 x 110	185 x 255 x 110
6.05	6.2
7.90	8.13

45/52.5 mm	45/52.5 mm
45/70 mm	45/70 mm
4 x 240	4 x 240

<input type="radio"/>	<input type="radio"/>
<input type="radio"/>	<input type="radio"/>

Characteristics and Performance

ComPacT NSXm Switch-Disconnectors from 50 to 160 A NA

Installation standards require upstream protection. However ComPacT NSXm 50 to 160 NA switch-disconnectors are self-protected by their high-set magnetic release.

A



ComPacT NSXm switch-disconnectors

Common Characteristics

Rated voltages	Insulation voltage (V)	Ui	800
	Impulse withstand voltage (kV)	Uimp	8
	Operational voltage (V)	Ue	AC 50/60 Hz 690
Suitability for isolation		IEC/EN 60947-3	yes
Utilization category		AC 22 A/AC 23 A	
Pollution degree		IEC 60664-1	3

Switch-Disconnectors

Electrical characteristics as per IEC/EN 60947-3

Conventional thermal current (A) I_{th} 40 °C

Number of poles

Operational current (A) depending on the utilization category	I _e	AC 50/60 Hz	220/240 V 380/415 V 440/480 V 500/525 V 660/690 V
---	----------------	-------------	---

Short-circuit making capacity (kA peak)	I _{cm}	min. (switch-disconnector alone) max. (protection by upstream circuit breaker)
---	-----------------	---

Rated short-time withstand current (A rms)	I _{cw}	for	1 s 3 s 20 s
--	-----------------	-----	--------------------

Durability (C-O cycles)	Mechanical		
	Electrical	AC	440 V I _e /2 690 V I _e /2

Positive contact indication

Pollution degree

Additional indication and control auxiliaries

Indication contacts

Voltage releases	MX shunt trip release MN undervoltage release
------------------	--

Installation/connections

Dimensions and Weights

Dimensions (mm)	3P
W x H x D	4P
Weight (kg)	3P 4P

Connections

Pitch (mm)	Standard With spreaders
EverLink lug Cu or Al [1] cables	Cross-section (mm ²) Rigid Flexible
Crimp lugs Cu or Al	Cross-section (mm ²) Rigid Flexible

Source-changeover systems

Manual mechanical interlocking

[1] Al up to 100 A.

Characteristics and Performance

ComPacT NSXm Switch-Disconnectors from 50 to 160 A NA



Common Characteristics			
Control	Manual	With toggle	<input checked="" type="radio"/>
		With direct or extended rotary handle	<input checked="" type="radio"/>
		With side rotary handle	<input checked="" type="radio"/>
Versions	Fixed		<input checked="" type="radio"/>

	NSXm50NA	NSXm100NA	NSXm160NA
	50	100	160
	3, 4	3, 4	3, 4
	AC22A/AC23A	AC22A/AC23A	AC22A/AC23A
	50	100	160/100
	50	100	160/100
	50	100	160/100
	50	100	160/100
	50	100	160/100
	1.28	2.13	2.13
	150	150	150
	900	1500	1500
	900	1500	1500
	200	335	335
	20000	20000	20000
	AC22A/AC23A	AC22A/AC23A	AC22A/AC23A
	20000/20000	20000/20000	20000/20000
	10000/10000	10000/10000	10000/10000
	10000/6000	10000/6000	10000/6000
	5000/3000	5000/3000	5000/3000
	<input checked="" type="radio"/>	<input checked="" type="radio"/>	<input checked="" type="radio"/>
	3	3	3
	<input checked="" type="radio"/>	<input checked="" type="radio"/>	<input checked="" type="radio"/>
	<input checked="" type="radio"/>	<input checked="" type="radio"/>	<input checked="" type="radio"/>
	<input checked="" type="radio"/>	<input checked="" type="radio"/>	<input checked="" type="radio"/>
	81 x 137 x 80		
	108 x 137 x 80		
	1.06		
	1.42		
	27		
	35		
	95		
	70		
	120		
	95		
	<input checked="" type="radio"/>		

Characteristics and Performance

ComPacT NSX Switch-Disconnectors from 100 to 630 A NA

Installation standards require upstream protection. However ComPacT NSX100 to 630 NA switch-disconnectors are self-protected by their high-set magnetic release.

A



ComPacT NSX100 to 250 NA



ComPacT NSX400 to 630 NA

> Discover our specific switch-disconnectors offer: ComPacT INS/INV



LVPED213024EN

[1] 2P in 3P case.

Common Characteristics

Rated voltages	Insulation voltage (V)	Ui	800
	Impulse withstand voltage (kV)	Uimp	8
	Operational voltage (V)	Ue	AC 50/60 Hz 690
Suitability for isolation		IEC/EN 60947-3	yes
Utilization category		AC 22 A/AC 23 A - DC 22 A/DC 23 A	
Pollution degree		IEC 60664-1	3

Switch-Disconnectors

Electrical characteristics as per IEC/EN 60947-3

Conventional thermal current (A)	Ith 50 °C				
Number of poles					
Operational current (A) depending on le the utilization category		AC 50/60 Hz			
			220/240 V		
			380/415 V		
			440/480 V		
			500/525 V		
		DC			
			250 V (1 pole)		
			500 V (2 poles in series)		
			750 V (3 poles in series)		
Short-circuit making capacity (kA peak)	Icm	for	Min. (switch-disconnector alone)		
			Max. (protection by upstream circuit breaker)		
Rated short-time withstand current (A rms)	Icw	for	1 s		
			3 s		
			20 s		
Durability (C-O cycles)	Mechanical	AC			
				440 V	In/2
				690 V	In/2
	Electrical	DC		250 V (1 pole) and In/2	
				500 V (2 poles in series) In	

Positive contact indication

Pollution degree

Protection

Add-on earth-leakage protection	By VigiPacT add-on
	By VigiPacT relay

Additional indication and control auxiliaries

Indication contacts

Voltagés releases	MX shunt release
	MN undervoltage release

Current-transformer module

Insulation monitoring module

Remote communication by bus

Device-status indication

Device remote operation

Operation counter

Installation/connections

Dimensions (mm)	Fixed, front connections	2/3P
		4P
W x H x D		
Weight (kg)	Fixed, front connections	3P
		4P

Source-changeover systems

(see chapter on Source-changeover systems)

Manual mechanical interlocking

Automatic source-changeover

Characteristics and Performance

ComPacT NSX Switch-Disconnectors from 100 to 630 A NA



Common Characteristics

Control	Manual	With toggle	<input checked="" type="radio"/>
		With direct or extended rotary handle	<input checked="" type="radio"/>
Versions	Electrical	With remote control	<input checked="" type="radio"/>
	Fixed		<input checked="" type="radio"/>
	Withdrawable	Plug-in base	<input checked="" type="radio"/>
		Chassis	<input checked="" type="radio"/>

NSX100NA	NSX160NA	NSX250NA	NSX400NA	NSX630NA
100	160	250	400	630
2 [1], 3, 4	2 [1], 3, 4	2 [1], 3, 4	3, 4	3, 4
AC22A/AC23A	AC22A/AC23A	AC22A/AC23A	AC22A/AC23A	AC22A/AC23A
100	160	250	400	630
100	160	250	400	630
100	160	250	400	630
100	160	250	400	630
DC22A/DC23A	DC22A/DC23A	DC22A/DC23A	-	-
100	160	250	-	-
100	160	250	-	-
100	160	250	-	-
2.6	3.6	4.9	7.1	8.5
330	330	330	330	330
1800	2500	3500	5000	6000
1800	2500	3500	5000	6000
690	960	1350	1930	2320
50000	40000	20000	15000	15000
AC22A/AC23A	AC22A/AC23A	AC22A/AC23A	AC22A/AC23A	AC22A/AC23A
35000	30000	15000	10000	6000
20000	15000	7500	5000	3000
15000	10000	6000	5000	3000
8000	5000	3000	2500	1500
10000	10000	10000	-	-
5000	5000	5000	-	-
<input checked="" type="radio"/>	<input checked="" type="radio"/>	<input checked="" type="radio"/>	<input checked="" type="radio"/>	<input checked="" type="radio"/>
3	3	3	3	3
<input checked="" type="radio"/>			<input checked="" type="radio"/>	
<input checked="" type="radio"/>			<input checked="" type="radio"/>	
<input checked="" type="radio"/>			<input checked="" type="radio"/>	
<input checked="" type="radio"/>			<input checked="" type="radio"/>	
<input checked="" type="radio"/>			<input checked="" type="radio"/>	
<input checked="" type="radio"/>			<input checked="" type="radio"/>	
<input checked="" type="radio"/>			<input checked="" type="radio"/>	
<input checked="" type="radio"/>			<input checked="" type="radio"/>	
105 x 161 x 86			140 x 255 x 110	
140 x 161 x 86			185 x 255 x 110	
1.5 to 1.8			5.2	
2.0 to 2.2			6.8	
<input checked="" type="radio"/>			<input checked="" type="radio"/>	
<input checked="" type="radio"/>			<input checked="" type="radio"/>	

General Characteristics of the ComPacT Range

DB43277.ai

A

A	NSXm 160H		B
C	C12H3TM160L		B
D	Ui 800V	Uimp 8kV	E
	Ue(V)	Icu(kA)	Ics(kA)
	220-240 ~	100	100
	380-415 ~	70	70
	440 ~	65	65
F			F
G	50/60Hz	40°C	
	IEC/EN 60947-2	Cat A	

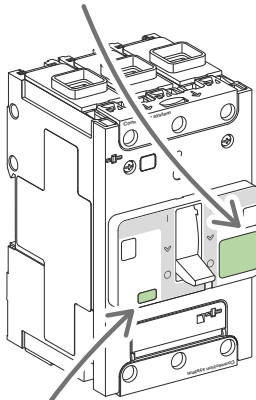

H	Ir(A) 63/160
	In=60A

Standardized characteristics indicated on the rating plate:

- A** Type of device: frame size and breaking capacity class
- B** Circuit breaker/switch-disconnector symbol
- C** Commercial reference
- D** Ui: rated insulation voltage
- E** Uimp: rated impulse withstand voltage
- F** Ue: operational voltage
- G** Reference standard
- H** Circuit breaker rating

Note: When the circuit breaker is equipped with an extended rotary handle, the door must be opened to access the rating plate.

DB41074.eps



Compliance with Standards

ComPacT NSX and NSXm circuit breakers and switch-disconnectors comply with the following:

- International standards
 - IEC 60947-1: general rules
 - IEC 60947-2: circuit breakers
 - IEC 60947-3: switch-disconnectors
 - IEC 60947-4-1: contactors and motor starters ^[1]
 - IEC 60947-5-1 and following: control circuit devices and switching elements; automatic control components
- European standards (EN 60947-1, EN 60947-2, EN 60947-3 and EN 60947-5-1)
 - China CCC
 - EAC (Customs Union)
- The specifications of the marine classification companies (Veritas, Lloyd's Register of Shipping, Det Norske Veritas, etc.), recommendations issued by the CNOMO organization for the protection of machine tools.

Pollution Degree

ComPacT NSX and NSXm circuit breakers and switch-disconnectors are certified for operation in pollution degree 3 environments as defined by IEC standards 60947-1 and 60664-1 (industrial environments).

Climatic Withstand

ComPacT NSX and NSXm circuit breakers have successfully passed the tests defined by the following standards for extreme atmospheric conditions.

Dry cold and dry heat

- IEC 60068-2-1: dry cold at -55 °C
- IEC 60068-2-2: dry heat at +85 °C

Damp heat (tropicalization)

- IEC 60068-2-30: damp heat (temperature + 55 °C and relative humidity of 95 %)
- IEC 60068-2-52: severity 2 - Cycling salt mist

Environment

ComPacT NSX and NSXm respects the European environment directive EC/2002/95 concerning the restriction of hazardous substances (RoHS) and is Green Premium.

Product environment profiles (PEP) have been prepared, describing the environmental impact of every product throughout its life cycle, from production to the end of its service life.

All ComPacT production sites have set up an environmental management system certified ISO 14001.

Each factory monitors the impact of its production processes. Every effort is made to prevent pollution and to reduce consumption of natural resources.

Ambient Temperature

- ComPacT NSX and NSXm circuit breakers may be used between -25 °C And +70 °C. For temperatures higher than 40 °C, (For ComPacT NSX: +65 °C for circuit breakers used to protect motor feeders) devices must be derated (pages E-8 to E-9 and E-14 to E-17).
- Circuit breakers should be put into service under normal ambient, operating-temperature conditions. Exceptionally, the circuit breaker may be put into service when the ambient temperature is between -35 °C and -25 °C.
- The permissible storage temperature range for ComPacT NSX and NSXm circuit breakers in the original packing is -50 °C ^[2] ^[3] and +85 °C.

[1] For ComPacT NSX

[2] For ComPacT NSXm: - 40 °C for ComPacT NSXm MicroLogic Vigi 4.1.

[3] For ComPacT NSX: -40 °C for MicroLogic control units with an LCD screen and MicroLogic Vigi 4.

Select Circuit Breakers and Switch-Disconnectors

General Characteristics of the ComPacT Range

Electromagnetic Compatibility

ComPacT NSX and NSXm devices are protected against:

- Overvoltages caused by circuit switching (e.g. lighting circuits)
- Overvoltages caused by atmospheric disturbances
- Devices emitting radio waves such as mobile telephones, radios, walkie-talkies, radar, etc.
- Electrostatic discharges produced by users.

Immunity levels for ComPacT NSXm comply with the standards below.

- IEC/EN 60947-2: Low-voltage switchgear and controlgear, part 2: Circuit breakers:
 - Annex F: Immunity tests for circuit breakers with electronic protection
 - Annex B: Immunity tests for residual current protection
- IEC/EN 61000-4-2: Electrostatic-discharge immunity tests
- IEC/EN 61000-4-3: Radiated, radio-frequency, electromagnetic-field immunity tests
- IEC/EN 61000-4-4: Electrical fast transient/burst immunity tests
- IEC/EN 61000-4-5: Surge immunity tests
- IEC/EN 61000-4-6: Immunity tests for conducted disturbances induced by radio-frequency fields
- IEC/EN 61000-4-8: Power frequency magnetic field immunity test
- IEC/EN 61000-4-11: Voltage dips, short interruptions and voltage variations immunity tests
- CISPR 11: Industrial, scientific and medical equipment - Radio-frequency disturbance characteristics - Limits and methods of measurement.

Suitable for Isolation with Positive Contact Indication

All ComPacT NSX and NSXm devices are suitable for isolation as defined in IEC standard 60947-2:

- The isolation position corresponds to the O (OFF) position.
- The operating handle cannot indicate the OFF position unless the contacts are effectively open.
- Padlocks may not be installed unless the contacts are open.

Installation of a rotary handle or a motor mechanism does not alter the reliability of the position-indication system.

The isolation function is certified by testing:

- The mechanical reliability of the position-indication system
 - The absence of leakage currents
 - Overvoltage withstand capacity between upstream and downstream connections.
- The tripped position does not insure isolation with positive contact indication. Only the OFF position confirms isolation.

Installation in Class II Switchboards

All ComPacT NSX and NSXm devices are class II front face devices. They may be installed through the door of class II switchboards (as per IEC standards 61140 and 60664-1) without downgrading switchboard insulation. Installation requires no special operations, even when the circuit breaker is equipped with a rotary handle or a motor mechanism.

Degree of Protection

The following indications are in accordance with standards IEC 60529 (IP degree of protection) and IEC 62262 (IK protection against external mechanical impacts).

Bare Circuit Breaker with Terminal Shields

- With toggle: IP40, IK07
- With direct rotary handle: IP40 IK07

Circuit Breaker Installed in a Switchboard

ComPacT NSXm

- With toggle: IP40, IK07
- With direct rotary handle: IP40, IK07
- With extended rotary handle: IP54 or IP65 IK08
- With side rotary handle: IP54 or IP65 IK08

ComPacT NSX

- With toggle: IP40, IK07
- With direct rotary handle:
 - Standard/VDE: IP40, IK07
 - MCC: IP43 IK07
 - CNOMO: IP54 IK08
- With extended rotary handle: IP55 IK08
- With motor mechanism: IP40 IK07

For more detail about IP, see [page E-7](#).

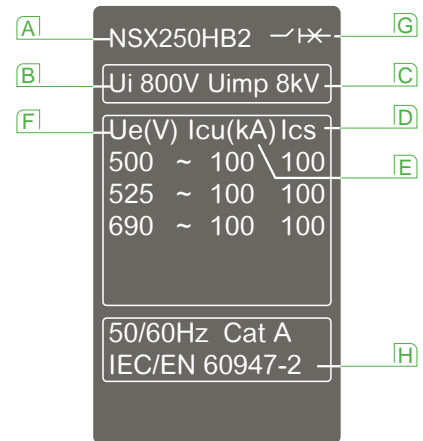

Standardized characteristics indicated on the rating plate:

- A** Type of device: frame size and breaking capacity class
- B** Ui: rated insulation voltage
- C** Uimp: rated impulse withstand voltage
- D** Ics: service breaking capacity
- E** Icu: ultimate breaking capacity for various values of the rated operational voltage Ue
- F** Ue: operational voltage
- G** Circuit breaker/switch-disconnector symbol
- H** Reference standard

Note: When the circuit breaker is equipped with an extended rotary handle, the door must be opened to access the rating plate.

ComPacT NSX Special Applications

High Performance at 690 V

ComPacT NSX R/HB1/HB2 circuit breaker is designed specifically for the needs of systems operating at 690 V.

A



ComPacT NSX100 to 250



ComPacT NSX400 to 630

Markets

- Marine
- Oil and gas
- Data centers
- Other markets pursuing energy efficiency (water, industrial, etc.).

Ability to Service High Power Densities

- Upgrade voltage from ~415-440 to 690 V system allows:
 - Smaller cables can be used
 - Reduced cost and space
 - Reduced energy loss in transmission
 - Motors are more efficient at 690 V
- Consider 690 V as an alternative MV system:
 - Lower cost, smaller footprint, and improved maintenance.

Safety

IACS (International Association of Classification Societies) change, requires Ics rating for emergency systems:

- Key influence on Marine systems of high Ics ratings
- Continuity of service after 3 faults.

Technology

- Best in class technology and performance:
 - High breaking capacity
 - NSX family consistency of energy metering, alarming and diagnosis
- Provides alternative to fuse protection at 690 V applications.

Enhancing Solutions

- Using smaller frames for 690 V high performance circuits:
 - Space and cost benefit
 - NSX family consistency with same NSX accessories
- 200 kA breaking capacity on R rating will be mainly used for:
 - High power factor applications: around 2.8 instead of 2.2
 - Selectivity with MasterPact UR.

Type I & II Coordination for Motor Applications

- Type I & II coordination with TeSys contactors is available up to 690 V.
- Coordination tables are prepared with external overload relays and protection integrated into the MicroLogic trip units.
- See complementary bulletin for ratings.

Compliance with Standards

ComPacT NSX circuit breakers and auxiliaries comply with the following:

- International recommendations
 - IEC 60947-1: general rules
 - IEC 60947-2: circuit breakers
 - IEC 60947-3: switch-disconnectors
 - IEC 60947-4: contactors and motor starters
 - IEC 60947-5.1 and following: control circuit devices and switching elements; automatic control components
- European (EN 60947-1, EN 60947-2, EN 60947-3 and EN 60947-5.1) and corresponding national standards
 - China CCC
 - EAC (Customs Union)
- The specifications of the marine classification companies (Veritas, Lloyd's Register of Shipping, Det Norske Veritas, etc.), recommendations issued by the CNOMO organization for the protection of machine tools.

Select Circuit Breakers and Switch-Disconnectors

ComPacT NSX Special Applications

High Performance at 690 V

Circuit Breakers (Fed from Bottom)			NSX100-250 [1]			NSX400			NSX630		
Breaking Capacity Levels			R	HB1	HB2	R	HB1	HB2	R	HB1	HB2
Electrical characteristics											
Breaking capacity (kA rms)											
Icu	AC 50/60 Hz	220/240 V	150	-	-	150	-	-	150	-	-
		380/415 V	150	-	-	150	-	-	150	-	-
		440 V	130	-	-	130	-	-	130	-	-
		500 V	70	70	70	40	40	50	40	40	50
		525 V	50	50	50	35	35	40	35	35	40
		690 V	20	20	20	30	30	35	30	30	35
Service breaking capacity (kA rms)											
Ics	AC 50/60 Hz	220/240 V	150	-	-	150	-	-	150	-	-
		380/415 V	150	-	-	150	-	-	150	-	-
		440 V	130	-	-	130	-	-	130	-	-
		500 V	70	70	70	40	40	50	40	40	50
		525 V	50	50	50	10	10	12	10	10	12
		690 V	10	10	10	10	10	10	10	10	10

[1] There is no 160 A frame, use the 250 A frame with lower rating trip units.

Offer Structure

The ComPacT NSX HB offer has some differences compared to the standard NSX offer.

- 100 A frame and 250 A frame, there is no 160 A frame. The 125 - 160 A trip units are used in a 250 A frame.
- All R, HB1 and HB2 circuit breakers can be fed from top and bottom of the circuit breaker.
- [2] Check the remark: check both tables from performance of each supply.
- ComPacT NSX400-630 R/HB1/HB2, U > 440 V, Icu 20 kA, Line/Load connection possible with insulation screen.
- All trip units are assembled in factory.

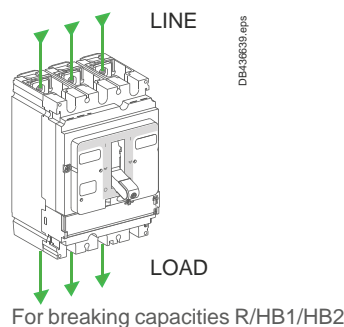

Type of protection	Distribution protection		Motor protection	
	TMD	MicroLogic	MA	MicroLogic
ComPacT NSX100	40-100	2.2: 40-100 5.2 E: 40-100 6.2 E: 40-100	12.5-100	2.2 M: 25, 50, 100 6.2 E-M: 25, 50, 100
ComPacT NSX250	125-250	2.2: 100, 160, 250 5.2 E: 100, 160, 250 6.2 E: 100, 160, 250	150, 220	2.2 M: 150, 220 6.2 E-M: 150, 220
ComPacT NSX400	-	2.3: 250, 400 5.3 E: 250, 400 6.3 E: 250, 400	-	1.3 M: 320 2.3 M: 320 6.3 M: 320
ComPacT NSX630	-	2.3: 630 5.3 E: 630 6.3 E: 630	-	1.3 M: 500 2.3 M: 500 6.3 M: 500



Select Protection

Trip Unit Overview

Protection of Distribution Systems

ComPacT NSXm TM Thermal-Magnetic Trip Units	B-4
ComPacT NSX TM Thermal-Magnetic and MA Magnetic Trip Units	B-6
Function Overview	B-8
ComPacT NSXm + NSX Circuit Breakers Trip Units	B-9
ComPacT NSX MicroLogic 2 and 1.3 Trip Units.....	B-10
ComPacT NSX MicroLogic 5/6 E Trip Units.....	B-12
ComPacT NSXm MicroLogic Vigi 4.1 Trip Unit.....	B-14
ComPacT NSX MicroLogic Vigi 4 Trip Unit.....	B-16
ComPacT NSX MicroLogic Vigi 7 E Trip Unit.....	B-18
ComPacT NSX MicroLogic Vigi 7 E Trip Unit.....	B-20
ComPacT NSX VigiPacT Add-on Protection Against Insulation Faults.....	B-22

ComPacT NSX Motor Protection

General Information on Motor Feeders	B-26
Motor-Feeder Characteristics and Solutions	B-28
Motor-Feeder Solutions.....	B-29
MA Instantaneous Trip Units	B-30
MicroLogic 1.3 M Instantaneous Trip Units	B-31
MicroLogic 2.2/2.3 M Electronic Trip Units.....	B-32
MicroLogic 6 E-M Electronic Trip Units	B-34

ComPacT NSX Measurement

MicroLogic 5/6/7 E Electronic Trip Units.....	B-38
---	------

ComPacT NSX Diagnostics & Maintenance

MicroLogic 5/6/7 E Electronic Trip Units.....	B-42
---	------

ComPacT NSX Special Applications

Protection of Public Distribution Systems with MicroLogic 2-AB.....	B-45
ComPacT NSX MicroLogic Vigi 4-AB Trip Unit with Embedded Earth Leakage Protection	B-48
Generator Protection with MicroLogic 2.2 G.....	B-50
Protection of Industrial Control Panels	B-52
16 Hz 2/3 Network Protection - MicroLogic 5 A-Z Trip Unit	B-54
Protection of 400 Hz Systems	B-55
ComPacT NSX400K at 1000 V AC	B-58

Other Chapters

Select Circuit Breakers and Switch-Disconnectors	A-1
Customize Circuit Breakers with Accessories.....	C-1
Smart Panel Integration	D-1
Switchboard Integration.....	E-1
Catalog Numbers	F-1
Glossary	G-1
Additional Characteristics.....	H-1







Select Protection

Trip Unit Overview

ComPacT NSXm has a built-in trip unit.

B

	ComPacT NSXm up to 160 A		ComPacT NSX up to 250 A	
	 <p>C12H4TM160L.eps</p> <p>TM-D Distribution</p>	 <p>C12H4V160L.eps</p> <p>MicroLogic Vigi 4.1 Distribution and Earth Leakage Protection</p>	 <p>C25W3M250.eps</p> <p>MA Distribution and Motors</p>	 <p>C25W3TM250.eps</p> <p>TM-D Distribution TM-G Generators</p>

	LI	LS ₀ IR	I	LI
Protections				
Standard protections				
Settings and indications	Pick-up set in amps using dials Non-adjustable time delay			
Front indication	●	●	●	●
Test connector		●		
Self test	●	●	●	●
Measurements				
Embedded measurements ^[1]				
Diagnostic & Maintenance				
Status indication	●	●	●	●
Operating assistance				
Control				
Voltage release	●	●	●	●
Motor mechanism			●	●
Communication				
Modbus SL			●	●
Ethernet			●	●
Local display			●	●
Input/Output control				
SDx		●		
I/O module			●	●
Earth Leakage				
Embedded protection		●		
VigiPacT add-on module			●	●
VigiPacT relay	●		●	●

[1] For more details, refer to page B-41.

ComPact NSX offers a range of trip units in interchangeable cases, whether they are magnetic, thermal-magnetic or electronic. Versions 5 and 6 of the electronic trip unit offer communication and metering. Using MicroLogic sensors and intelligence, ComPact NSX supplies all the information required to manage the electrical installation and optimize energy use.

ComPact NSX up to 630 A



MicroLogic 2 and 1.3 100-250 A 400-630 A		MicroLogic 4 100-250 A 400-630 A		MicroLogic 5 and 6 100-250 A 400-630 A		MicroLogic 7 100-250 A 400-630 A	
Distribution		Distribution and earth-leakage protection		Distribution and generators		Distribution and earth-leakage protection	
2.2	2.3	2.2	2.3	5.2 E/6.2 E	5.3 E/6.3 E	7.2 E	7.3 E
Service connection utilities		Service connection utilities		Motors			
2.2 AB	2.3 AB	4.2 AB	4.3 AB	6.2 E-M	6.3 E-M	7.2 E AL	7.3 E AL
Motors		4.2 AL 4.3 AL					
2.2 M	1.3 M/2.3 M						
Generators							
2.2 G	2.3 G						
2.2 G	2.3 G						

LS ₀ I	LS ₀ I	LSI, LSIG	LSIR
Pick-up set in amps using dials			
Non-adjustable time delay			
<input type="checkbox"/>	<input type="checkbox"/>	<input type="checkbox"/>	<input type="checkbox"/>
<input type="checkbox"/>	<input type="checkbox"/>	<input type="checkbox"/>	<input type="checkbox"/>
<input type="checkbox"/>	<input type="checkbox"/>	<input type="checkbox"/>	<input type="checkbox"/>
<input type="checkbox"/>	<input type="checkbox"/>	<input type="checkbox"/>	<input type="checkbox"/>
<input type="checkbox"/>	<input type="checkbox"/>	<input type="checkbox"/>	<input type="checkbox"/>
<input type="checkbox"/>	<input type="checkbox"/>	<input type="checkbox"/>	<input type="checkbox"/>
<input type="checkbox"/>	<input type="checkbox"/>	<input type="checkbox"/>	<input type="checkbox"/>
<input type="checkbox"/>	<input type="checkbox"/>	<input type="checkbox"/>	<input type="checkbox"/>
<input type="checkbox"/>	<input type="checkbox"/>	<input type="checkbox"/>	<input type="checkbox"/>
<input type="checkbox"/>	<input type="checkbox"/>	<input type="checkbox"/>	<input type="checkbox"/>
<input type="checkbox"/>	<input type="checkbox"/>	<input type="checkbox"/>	<input type="checkbox"/>
<input type="checkbox"/>	<input type="checkbox"/>	<input type="checkbox"/>	<input type="checkbox"/>
<input type="checkbox"/>	<input type="checkbox"/>	<input type="checkbox"/>	<input type="checkbox"/>
<input type="checkbox"/>	<input type="checkbox"/>	<input type="checkbox"/>	<input type="checkbox"/>
<input type="checkbox"/>	<input type="checkbox"/>	<input type="checkbox"/>	<input type="checkbox"/>
<input type="checkbox"/>	<input type="checkbox"/>	<input type="checkbox"/>	<input type="checkbox"/>
<input type="checkbox"/>	<input type="checkbox"/>	<input type="checkbox"/>	<input type="checkbox"/>
<input type="checkbox"/>	<input type="checkbox"/>	<input type="checkbox"/>	<input type="checkbox"/>
<input type="checkbox"/>	<input type="checkbox"/>	<input type="checkbox"/>	<input type="checkbox"/>
<input type="checkbox"/>	<input type="checkbox"/>	<input type="checkbox"/>	<input type="checkbox"/>

B

Protection of Distribution Systems

ComPacT NSXm TM Thermal-Magnetic Trip Units

ComPacT NSXm has a built-in thermal magnetic trip unit.



ComPacT NSXm 160

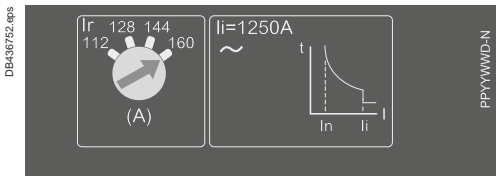

B

TM-D Thermal-Magnetic Trip Units

Circuit breakers equipped with thermal-magnetic trip units are used mainly in industrial and commercial electrical distribution applications for protection of cables on distribution systems supplied by transformers.

Protection

L Thermal Protection (I_r)

Thermal overload protection based on a bimetal strip providing an inverse time curve I^2t , corresponding to a temperature rise limit. Above this limit, the deformation of the strip trips the circuit breaker operating mechanism.

This protection operates according to:

- I_r that can be adjusted in amps from 0.7 to 1 times the rating of the circuit breaker (16 A to 160 A), corresponding to settings from 11 to 160 A for the range of products
- A non-adjustable time delay for cable protection.

I Magnetic Protection (I_i)

Short-circuit protection with a fixed pick-up I_i that initiates instantaneous tripping if exceeded with a non-adjustable time delay for selectivity and cascading.

Protection Versions

- 3-pole:
 - 3P 3D: 3-pole frame (3P) with detection on all 3 poles (3D)
- 4-pole:
 - 4P 3D: 4-pole frame (4P) with detection on 3 poles (3D)
 - 4P 4D: 4-pole frame (4P) with detection on all 4 poles (same threshold for phases and neutral).

Note: All the circuit breakers have a transparent lead-sealable cover that avoids access to the adjustment dials.

Protection of Distribution Systems

ComPacT NSXm TM Thermal-Magnetic Trip Units

Thermal-Magnetic Trip Units TM16D to 160D

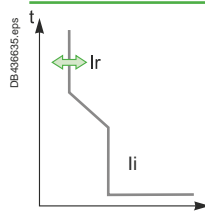

Ratings (A)	In at 40 °C ^[1]	16	25	32	40	50	63	80	100	125	160
Circuit breaker	ComPacT NSXm	<input checked="" type="radio"/>	<input checked="" type="radio"/>	<input checked="" type="radio"/>	<input checked="" type="radio"/>	<input checked="" type="radio"/>	<input checked="" type="radio"/>	<input checked="" type="radio"/>	<input checked="" type="radio"/>	<input checked="" type="radio"/>	<input checked="" type="radio"/>
L Thermal protection											
Pick-up (A) tripping between 1.05 and 1.20 Ir	$I_r = I_n \times \dots$	Adjustable in amps from 0.7 to 1 x In									
Time delay (s)	tr	Non-adjustable									
I Magnetic protection											
Pick-up (A)	Ii	Fixed									
accuracy ±20 %	ComPacT NSXm	500	600	600	600	600	800	1000	1250	1250	1250
Time delay	tm	Fixed									
Neutral protection											
Unprotected neutral	4P 3D	No detection									
Fully protected neutral	4P 4D	1 x Ir									

[1] If the circuit breakers are used in high-temperature environments, the setting must take into account the thermal limitations of the circuit breaker. See the temperature derating table.



Protection of Distribution Systems

ComPacT NSX TM Thermal-Magnetic and MA Magnetic Trip Units

TM thermal-magnetic and MA magnetic trip units can be used on ComPacT NSX100/160/250 circuit breakers with performance levels B/F/H/N/S/L. TM trip units are available in 2 versions:

- TM-D, for the protection of distribution cables
- TM-G, with a low threshold, for the protection of generators or long cable lengths



ComPacT NSX250 F

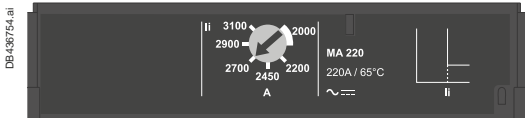

TM-D and TM-G Thermal-Magnetic Trip Units

Circuit breakers equipped with thermal-magnetic trip units are used mainly in industrial and commercial electrical distribution applications:

- TM-D, for protection of cables on distribution systems supplied by transformers
- TM-G, with a low pick-up for generators (lower short-circuit currents than with transformers) and distribution systems with long cable lengths (fault currents limited by the resistance of the cable).

Protection

Thermal Protection (Ir)

Thermal overload protection based on a bimetal strip providing an inverse time curve I^2t , corresponding to a temperature rise limit. Above this limit, the deformation of the strip trips the circuit breaker operating mechanism.

This protection operates according to:

- Ir that can be adjusted in amps from 0.7 to 1 times the rating of the trip unit (16 A to 250 A), corresponding to settings from 11 to 250 A for the range of trip units
- A non-adjustable time delay for cable protection.

Magnetic Protection (Ii)

Short-circuit protection with a fixed or adjustable pick-up Ii that initiates instantaneous tripping if exceeded.

- TM-D: fixed pick-up, Ii, for 16 to 160 A ratings and adjustable from 5 to 10 x In for 200 and 250 A ratings.
- TM-G: fixed pick-up for 16 to 250 A ratings.

Protection against insulation faults

Two solutions are possible by adding:

- A VigiPacT add-on acting directly on the trip unit of the circuit breaker
- A VigiPacT relay connected to an MN or MX voltage release.

Protection Versions

- 3-pole: 3P 3D: 3-pole frame (3P) with detection on all 3 poles (3D)
- 4-pole:
 - 4P 3D: 4-pole frame (4P) with detection on 3 poles (3D)
 - 4P 4D: 4-pole frame (4P) with detection on all 4 poles (same threshold for phases and neutral).

MA Magnetic Trip Units

In distribution applications, circuit breakers equipped with MA magnetic-only trip units are used for:

- Short-circuit protection of secondary windings of LV/LV transformers with overload protection on the primary side
- As an alternative to a switch-disconnector at the head of a switchboard in order to provide short-circuit protection.

Their main use is however for motor protection applications, in conjunction with a thermal relay and a contactor or motor starter.

Protection

Magnetic Protection (Ii)

Short-circuit protection with an adjustable pick-up Ii that initiates instantaneous tripping if exceeded.

- $Ii = In \times \dots$ set in amps on an adjustment dial covering the range 6 to 14 x In for 2.5 to 100 A ratings or 9 to 14 In for 150 to 220 A ratings.

Protection Versions

- 3-pole (3P 3D): 3-pole frame (3P) with detection on all 3 poles (3D)
- 4-pole (4P 3D): 4-pole frame (4P) with detection on 3 poles (3D)

Note: All the trip units have a transparent lead-sealable cover that avoids access to the adjustment dials.

Protection of Distribution Systems

ComPacT NSX TM Thermal-Magnetic and MA Magnetic Trip Units

B

Thermal-Magnetic Trip Units TM16D to 250D

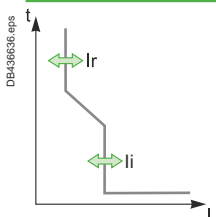

Ratings (A)	In at 40 °C [1]	16	25	32	40	50	63	80	100	125	160	200	250
Circuit breaker	ComPacT NSX100	●	●	●	●	●	●	●	●	-	-	-	-
	ComPacT NSX160	-	-	●	●	●	●	●	●	●	●	-	-
	ComPacT NSX250	-	-	-	-	-	-	●	●	●	●	●	●

L Thermal protection		
Pick-up (A) tripping between 1.05 and 1.20 Ir	$I_r = I_n \times \dots$	Adjustable in amps from 0.7 to 1 x In
Time delay (s)	tr	Non-adjustable
	tr at 1.5 x In	120 to 400
	tr at 6 x Ir	15

I Magnetic protection		
Pick-up (A) accuracy ±20 %	li	Fixed
	ComPacT NSX100	190 300 400 500 500 500 640 800
	ComPacT NSX160/250	190 300 400 500 500 500 640 800 1250 1250 5 to 10xIn
Time delay	tm	Fixed

Neutral protection		
Unprotected neutral	4P 3D	No detection
Fully protected neutral	4P 4D	1 x Ir

Thermal-Magnetic Trip Units TM16G to 250G

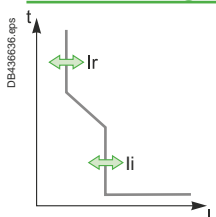

Ratings (A)	In at 40 °C [1]	16	25	40	63	80	100	125	160	200	250
Circuit breaker	ComPacT NSX100	●	●	●	●	●	●	-	-	-	-
	ComPacT NSX160	-	●	●	●	●	●	●	●	-	-
	ComPacT NSX250	-	-	-	-	-	-	-	●	●	●

L Thermal protection		
Pick-up (A) tripping between 1.05 and 1.20 Ir	$I_r = I_n \times \dots$	Adjustable in amps from 0.7 to 1 x In
Time delay (s)	tr	Non-adjustable
	tr at 1.5 x In	120 to 400
	tr at 6 x Ir	-

I Magnetic protection		
Pick-up (A) accuracy ±20 %	li	Fixed
	ComPacT NSX100	63 80 80 125 200 320 - - - -
	ComPacT NSX160	- 80 80 125 200 320 440 440 - -
	ComPacT NSX250	- - - - - - - 440 440 520
Time delay	tm	Fixed

Neutral protection		
Unprotected neutral	4P 3D	No
Fully protected neutral	4P 4D	1 x Ir

[1] For temperatures greater than 40 °C, the thermal protection characteristics are modified. See the temperature derating table.

Magnetic Trip Units MA 2.5 to 220

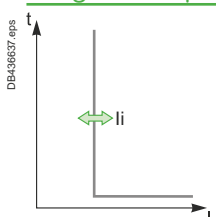

Ratings (A)	In at 65 °C [1]	2.5	6.3	12.5	25	50	100 [1]	150	220
Circuit breaker	ComPacT NSX100	●	●	●	●	●	●	-	-
	ComPacT NSX160	-	-	-	●	●	●	●	-
	ComPacT NSX250	-	-	-	-	-	●	●	●

I Instantaneous magnetic protection		
Pick-up (A) accuracy ±20 %	$I_i = I_n \times \dots$	Adjustable from 6 to 14 x In (settings 6, 7, 8, 9, 10, 11, 12, 13, 14)
		Adjustable from 9 to 14 x In (settings 9, 10, 11, 12, 13, 14)
Time delay (ms)	tm	Fixed

[1] MA100 3P adjustable from 6 to 14 x In.
MA100 4P adjustable from 9 to 14 x In.

Note: All the trip units have a transparent lead-sealable cover that avoids access to the adjustment dials.

Protection of Distribution Systems

Function Overview

B

Measurement

Energy management is the challenge of present and future generations. To meet this requirement, MicroLogic E incorporates all the measuring functions of a power meter.

Diagnostics and Maintenance

Optimal continuity of services as well as extended life of equipment is one of customer main concerns. For that purpose MicroLogic E trip units contributes to corrective, preventive and predictive maintenance.

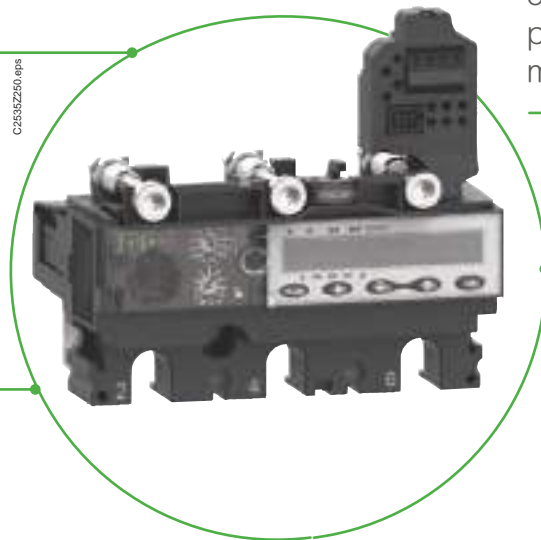

Protection

MicroLogic 5 (LSI), 6 (LSIG) and 7 (LSIR) offer a large long time delay setting range (0.4 to 1 xIn) and protection accuracy for a wide temperature range (-25 to +70 C).

Communication





- Protection Control Unit, provides local information for network operation and maintenance, as well as remote information for higher functions of control, monitoring, energy efficiency and assets management.
- To comply with those requirements MicroLogic trip unit and Enerlin'X communication system provides access to status, electrical values and devices control using Ethernet and Modbus SL communication protocols.

Protection of Distribution Systems

ComPacT NSXm + NSX Circuit Breakers Trip Units

B

Understanding the Names of MicroLogic Electronic Trip Units

Example: MicroLogic 6.3 E-M	6 Protection	3 Frame	E Measurements	M Applications
	<p>↓</p> <p>1: I 2: LS₀I 4: LS₀IR 5: LSI 6: LSIG</p> <p>I: Instantaneous L: Long time R: Residual current S₀: Short time [2] (fixed delay) S: Short time G: Ground fault</p> <p>↓</p>	<p>↓</p> <p>1: NSXm 16 to 160 </p> <p>2: NSX 100/160/250 </p> <p>3: NSX 400/630 </p> <p>↓</p>	<p>↓</p> <p>E: Energy </p> <p>↓</p>	<p>↓</p> <p>Distribution, otherwise G: Generator AB: Public distribution [1] M: Motors Z: 16 Hz 2/3 [1]</p> <p>↓</p>
Examples				
MicroLogic 1.3	Instantaneous only	400 or 630 A	-	Distribution
MicroLogic 2.3	LS ₀ I	400 or 630 A	-	Distribution
MicroLogic Vigi 4.1	LS ₀ IR	16 to 160 A	-	Distribution
MicroLogic 5.2 E	LSI	100, 160 or 250 A	Energy	Distribution
MicroLogic 6.3 E-M	LSIG	400 or 630 A	Energy	Motor

[1] AB-Z: except NSXm and NSX R, HB1, HB2.

[2] LS₀I protection is standard on MicroLogic 2. To allow selectivity, it offers short-time protection S₀ with a non-adjustable delay and instantaneous protection.

Select Protection

Protection of Distribution Systems

ComPacT NSX MicroLogic 2 and 1.3 Trip Units

MicroLogic 2 trip units can be used on ComPacT NSX100 to 630 circuit breakers with performance levels B/F/H/N/S/L/R/HB1/HB2.

They provide:

- Standard protection of distribution cables
- Indication of:
 - Overloads (via LEDs)
 - Overload tripping (via the SDx relay module).

DB436756.ai

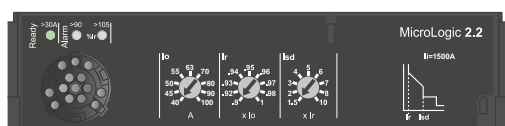

PB103377.eps



SDx remote indication relay module with its terminal block

DB436758.ai

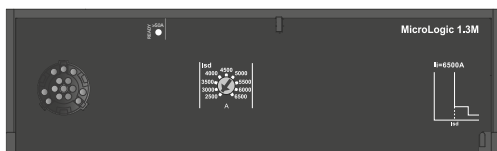

Note: All the trip units have a transparent lead-sealable cover that avoids access to the adjustment dials.

B-10

Life Is On

MicroLogic 2

Circuit breakers equipped with MicroLogic 2 trip units can be used to protect distribution systems supplied by transformers. For generators and long cables, MicroLogic 2 G trip units offer better suited low pick-up solutions (see page B-50).

Protection

Settings are made using the adjustment dials with fine adjustment possibilities.

L Overloads: Long Time Protection (Ir)

Inverse time protection against overloads with an adjustable current pick-up I_r set using a dial and a non-adjustable time delay t_r .

S Short-Circuits: Short-Time Protection with Fixed Time Delay (Isd)

Protection with an adjustable pick-up I_{sd} . Tripping takes place after a very short delay used to allow selectivity with the downstream device.

I Short-Circuits: Non-Adjustable Instantaneous Protection

Instantaneous short-circuit protection with a fixed pick-up.

Neutral Protection

- On 3-pole circuit breakers, neutral protection is not possible.
- On four-pole circuit breakers, neutral protection may be set using a three-position switch:
 - 4P 3D: neutral unprotected
 - 4P 3D + N/2: neutral protection at half the value of the phase pick-up, i.e. $0.5 \times I_r$
 - 4P 4D: neutral fully protected at I_r .

DB436756.ai

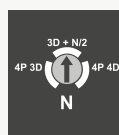

Indications

Front Indications

- Green "Ready" LED: flashes slowly when the circuit breaker is ready to trip in the event of a fault.
- Orange overload pre-alarm LED: steady on when $I > 90\% I_r$.
- Red overload LED: steady on when $I > 105\% I_r$.



Remote Indications

An overload trip signal can be remotely by installing an SDx relay module inside the circuit breaker.

This module receives the signal from the MicroLogic electronic trip unit via an optical link and makes it available on the terminal block. The signal is cleared when the circuit breaker is reclosed. For description, see page C-28.

MicroLogic 1.3 M for Magnetic Protection Only

MicroLogic 1.3 M trip units provide magnetic protection only, using electronic technology. They are dedicated to 400/630 A 3-poles (3P 3D) circuit breakers or 4-pole circuit breakers with detection on 3 poles (4P, 3D) and are used in certain applications to replace switch-disconnectors at the head of switchboards. They are especially used in 3-poles versions for motor protection, see page B-30.

Protection of Distribution Systems

ComPacT NSX MicroLogic 2 and 1.3 Trip Units

B

MicroLogic 2

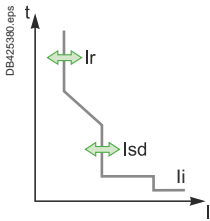

Ratings (A)	In at 40 °C [1]	40	100	160	250	400	630
Circuit breaker	ComPacT NSX100	●	●	-	-	-	-
	ComPacT NSX160	●	●	●	-	-	-
	ComPacT NSX250	●	●	●	●	-	-
	ComPacT NSX400	-	-	-	●	●	-
	ComPacT NSX630	-	-	-	●	●	●

L Long-time protection

Pick-up (A) tripping between 1.05 and 1.20 Ir	lo	Value depending on trip unit rating (In) and setting on dial								
In = 40 A	lo =	18	18	20	23	25	28	32	36	40
In = 100 A	lo =	40	45	50	55	63	70	80	90	100
In = 160 A	lo =	63	70	80	90	100	110	125	150	160
In = 250 A (NSX250)	lo =	100	110	125	140	160	175	200	225	250
In = 250 A (NSX400)	lo =	70	100	125	140	160	175	200	225	250
In = 400 A	lo =	160	180	200	230	250	280	320	360	400
In = 630 A	lo =	250	280	320	350	400	450	500	570	630
Ir = lo x ...		9 fine adjustment settings from 0.9 to 1 (0.9 - 0.92 - 0.93 - 0.94 - 0.95 - 0.96 - 0.97 - 0.98 - 1) for each value of lo								
Time delay (s) accuracy 0 to -20%	tr	Non-adjustable								
		1.5 x Ir	400							
		6 x Ir	16							
		7.2 x Ir	11							
Thermal memory		20 minutes before and after tripping								

S₀ Short-time protection with fixed time delay

Pick-up (A) accuracy ±10 %	Isd = Ir x ...	1.5	2	3	4	5	6	7	8	10
Time delay (ms)	tsd	Non-adjustable								
	Non-tripping time	20								
	Maximum break time	80								

I Instantaneous protection

Pick-up (A) accuracy ±15 %	Ii non-adjustable	600	1500	2400	3000	4800	6900			
	Non-tripping time	10 ms								
	Maximum break time	50 ms								

[1] If the trip units are used in high-temperature environments, the MicroLogic setting must take into account the thermal limitations of the circuit breaker. See the temperature derating table.

MicroLogic 1.3 M

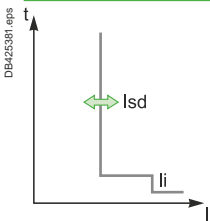

Ratings (A)	In at 65 °C [1]	320	500
Circuit breaker	ComPacT NSX400	●	-
	ComPacT NSX630	●	●

S Short-time protection

Pick-up (A) accuracy ±15 %	Isd	Adjustable directly in amps	
		9 settings: 1600, 1920, 2240, 2560, 2880, 3200, 3520, 3840, 4160 A	9 settings: 2500, 3000, 3500, 4000, 4500, 5000, 5500, 6000, 6500 A
Time delay (ms)	tsd	Non-adjustable	
	Non-tripping time	10	
	Maximum break time	60	

I Instantaneous protection

Pick-up (A) accuracy ±15 %	Ii non-adjustable	4800	6500
	Non-tripping time	0	
	Maximum break time	30 ms	

[1] Motor standards require operation at 65 °C. Circuit-breaker ratings are derated to take this requirement into account.

Protection of Distribution Systems

ComPacT NSX MicroLogic 5/6 E Trip Units

MicroLogic 5/6 E (Energy) trip units can be used on ComPacT NSX100 to 630 circuit breakers with performance levels B/F/H/N/S/L/R/HB1/HB2. They all have a display unit. They offer basic LSI protection (MicroLogic 5) or LSI and ground-fault protection G (MicroLogic 6). They also offer measurement, alarm and communication functions.

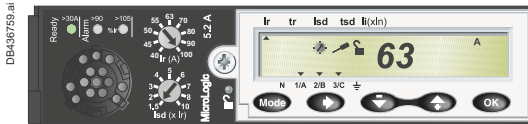

B

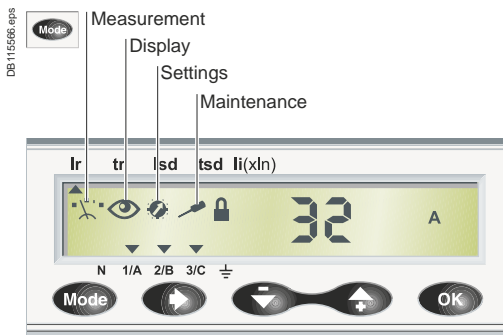

Trip unit menus

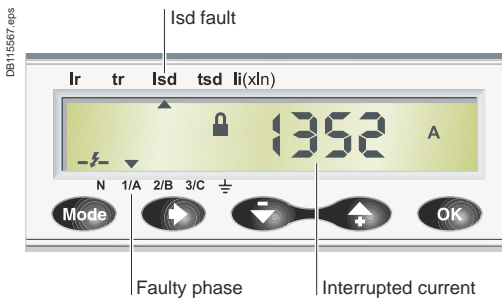

Display of interrupted current

Protection

Settings can be adjusted in two ways, using the dials and/or the keypad. The keypad can be used to make fine adjustments in 1 A steps below the maximum value defined by the setting on the dial. Access to setting modifications via the keypad is protected by a locking function displayed on the screen and controlled by a microswitch. The lock is activated automatically if the keypad is not used for 5 minutes. Access to the microswitch is protected by a transparent lead-sealable cover. With the cover closed, it is still possible to display the various settings and measurements using the keypad.

L Overloads: Long Time Protection (Ir)

Inverse time protection against overloads with an adjustable current pick-up **Ir** set using a dial or the keypad for fine adjustments. The time delay **tr** is set using the keypad.

S Short-Circuits: Short-Time Protection (Isd)

Short-circuit protection with an adjustable pick-up **Isd** and adjustable time delay **tsd**, with the possibility of including a portion of an inverse time curve (I²t On).

I Short-Circuits: Instantaneous Protection (Ii)

Instantaneous protection with adjustable pick-up **Ii**.

G Ground Fault Protection (Ig) on MicroLogic 6

Residual type ground-fault protection with an adjustable pick-up **Ig** (with Off position) and adjustable time delay **tg**. Possibility of including a portion of an inverse time curve (I²t On).

Neutral Protection

- On 4-pole circuit breakers, this protection can be set via the keypad:
 - Off: neutral unprotected
 - 0.5: neutral protection at half the value of the phase pick-up, i.e. 0.5 x Ir
 - 1.0: neutral fully protected at Ir
 - OSN: Oversized neutral protection at 1.6 times the value of the phase pick-up. Used when there is a high level of 3rd order harmonics (or orders that are multiples of 3) that accumulate in the neutral and create a high current. In this case, the device must be limited to Ir = 0.63 x In for the maximum neutral protection setting of 1.6 x Ir.
- With 3-pole circuit breakers, the neutral can be protected as an option by installing an external neutral sensor with the output (T1, T2) connected to the trip unit.

Zone Selective Interlocking (ZSI)

A ZSI terminal block may be used to interconnect a number of MicroLogic control units to provide zone selective interlocking for short-time (Isd) and ground-fault (Ig) protection, without a time delay. For ComPacT NSX 100 to 250, the ZSI function is available only in relation to the upstream circuit breaker (ZSI out).

Display of Type of Fault

On a fault trip, the type of fault (Ir, Isd, Ii, Ig), the phase concerned and the interrupted current are displayed. An external power supply is required.

Indications

Front Indications



- Green "Ready" LED: flashes slowly when the circuit breaker is ready to trip in the event of a fault.
- Orange overload pre-alarm LED: steady on when I > 90 % Ir.
- Red overload LED: steady on when I > 105 % Ir.

Remote Indications

An SDx relay module installed inside the circuit breaker can be used to remotely access to the following information:

- Overload trip
- Overload prealarm (MicroLogic 5) or ground fault trip (MicroLogic 6).

This module receives the signal from the MicroLogic electronic trip unit via an optical link and makes it available on the terminal block. The signal is cleared when the circuit breaker is closed.

These outputs can be reprogrammed to be assigned to other types of tripping or alarm. The module is described in detail in the section dealing with accessories.

Note: All the trip units have a transparent lead-sealable cover that avoids access to the adjustment dials.

Protection of Distribution Systems

ComPacT NSX MicroLogic 5/6 E Trip Units

MicroLogic 5/6 E Trip Units

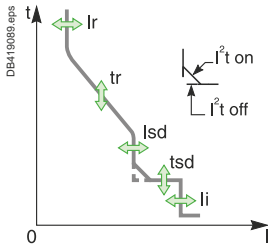

Ratings (A)	In at 40 °C [1]	40 [2]	100	160	250	400	630
Circuit breaker	ComPacT NSX100	●	●	-	-	-	-
	ComPacT NSX160	●	●	●	-	-	-
	ComPacT NSX250	●	●	●	●	-	-
	ComPacT NSX400	-	-	-	-	●	-
	ComPacT NSX630	-	-	-	-	●	●

L Long-time protection

Pick-up (A) tripping between 1.05 and 1.20 Ir	Ir = ...	Dial setting	Value depending on trip unit rating (In) and setting on dial												
		In = 40 A lo =	18	18	20	23	25	28	32	36	40				
		In = 100 A lo =	40	45	50	55	63	70	80	90	100				
		In = 160 A lo =	63	70	80	90	100	110	125	150	160				
		In = 250 A lo =	100	110	125	140	160	175	200	225	250				
		In = 400 A lo =	160	180	200	230	250	280	320	360	400				
		In = 630 A lo =	250	280	320	350	400	450	500	570	630				
		Keypad setting	Fine adjustment in 1 A steps below maximum value set on dial												
Time delay (s) accuracy 0 to -20 %	tr = ...	Keypad setting	0.5	1	2	4	8	16							
		1.5 x Ir	15	25	50	100	200	400							
		6 x Ir	0.5	1	2	4	8	16							
		7.2 x Ir	0.35	0.7	1.4	2.8	5.5	11							
Thermal memory			20 minutes before and after tripping												

S Short-time protection with adjustable time delay

Pick-up (A) accuracy ±10 %	Isd = Ir x ...	Dial setting for MicroLogic 5	1.5	2	3	4	5	6	7	8	10	
		Keypad settings for MicroLogic 6	Adjustment in steps of 0.5 x Ir over the range 1.5 x Ir to 10 x Ir									
Time delay (s)	tsd = ...	Keypad setting	I²Off	0	0.1	0.2	0.3	0.4				
			I²On	-	0.1	0.2	0.3	0.4				
		Non-tripping time (ms)		20	80	140	230	350				
		Maximum break time (ms)		80	140	200	320	500				

I Instantaneous protection

Pick-up (A) accuracy ±15 %	Ii = In x	Keypad setting	Adjustment in steps of 0.5 x In over the range 1.5 x In to: 15 x In (40 to 160 A), 12 x In (250 to 400 A) or 11 x In (630 A)									
		Non-tripping time	10 ms									
		Maximum break time	50 ms									

G Ground-fault protection - for MicroLogic 6 E

Pick-up (A) accuracy ±10 %	Ig = In x	Dial setting	Fine adjustment in 0.05 A steps using the keypad										
		In = 40 A	0.4	0.4	0.5	0.6	0.7	0.8	0.9	1	Off		
		In > 40 A	0.2	0.3	0.4	0.5	0.6	0.7	0.8	1	Off		
Time delay (s)	tg = ...	Keypad setting	I²Off	0	0.1	0.2	0.3	0.4					
			I²On	-	0.1	0.2	0.3	0.4					
		Non-tripping time (ms)		20	80	140	230	350					
		Maximum break time (ms)		80	140	200	320	500					
Test	Ig function		Built-in										

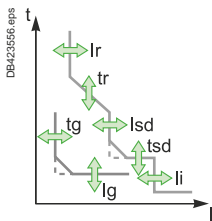

[1] If the trip units are used in high-temperature environments, the MicroLogic setting must take into account the thermal limitations of the circuit breaker. See the temperature derating table.

[2] For 40 A rating, the neutral N/2 adjustment is not possible.



Select Protection

Protection of Distribution Systems

ComPacT NSXm MicroLogic Vigi 4.1 Trip Unit with Integrated Earth Leakage Protection

ComPacT NSXm circuit breakers up to 160 A can be ordered with MicroLogic Vigi 4.1 trip unit with performance levels E/B/F/N/H.

They provide:

- Standard protection of distribution cables
- Earth leakage protection
- Indication of:
 - Overload alarming (via LEDs and via SDx module)
 - Overload tripping (via the SDx module)
 - Earth leakage alarming (via the SDx module)
 - Earth leakage tripping (via front face screen and the SDx module).

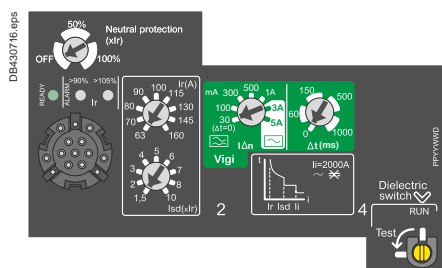

ComPacT NSXm MicroLogic Vigi 4.1

MicroLogic Vigi 4.1

Circuit breakers equipped with MicroLogic Vigi 4.1 trip units can be used for distribution systems supplied by transformers.

Short-Circuit and Overload Protection

Settings are made using the adjustment dials.

L Overloads: Long Time Protection (Ir)

Inverse time protection against overloads with a wide range adjustable current pick-up I_r set using a dial and a non-adjustable time delay t_r .

S Short-Circuits: Short-Time Protection with Fixed Time Delay (I_{sd})

Protection with an adjustable pick-up I_{sd} . Tripping takes place after a very short delay used to allow selectivity with the downstream device.

I Short-Circuits: Non-Adjustable Instantaneous Protection

Instantaneous short-circuit protection with a fixed pick-up.

Neutral Protection

- On 3-pole circuit breakers, neutral protection is not possible.
- On 4-pole circuit breakers, neutral protection may be set using a three-position switch:
 - OFF: neutral unprotected
 - 50 % ^[1]: neutral protection at half the value of the phase pick-up, i.e. $0.5 \times I_r$
 - 100 %: neutral fully protected at I_r

R Earth Leakage Protection

Protection with an adjustable leakage level ($I_{\Delta n}$) with an adjustable delay (Δt).

Compliance with Standards

- IEC 60947-2, annex B.
- IEC 60755, class A, immunity to DC components up to 6 mA.
- Operation down to -25°C as per VDE 664.

Power Supply

It is self-powered internally and therefore does not require any external source. It's still working even when supplied by only two phases.

Sensitivity $I_{\Delta n}$ (A)

- Type A: 30mA - 100mA - 300mA - 500mA - 1A.
- Type AC: 30mA - 100mA - 300mA - 1A - 3A - 5A.

Intentional Delay Δt (Ms)

0 - 60 ^[2] - 150 ^[2] - 500 ^[2] - 1000 ^[2].

Operated Voltage

200...440 V AC - 50/60 Hz.

Operating Safety

The earth leakage protection is a user safety device. It must be tested at regular intervals (every 6 months) using the test button.

[1] On 100A and 160A circuit breakers only.

[2] If the sensitivity is set to 30 mA, there is no time delay, whatever the time-delay setting.

Note: All the trip units have a transparent lead-sealable cover that avoids access to the adjustment dials.

Protection of Distribution Systems

ComPacT NSXm MicroLogic Vigi 4.1 Trip Unit with Integrated Earth Leakage Protection

Indications

Front Indications

- Green "Ready" LED: blinks slowly when the standard protection functions of the electronic trip unit are operational.
- Orange overload pre-alarm LED: steady on when $I > 90\% I_r$.
- Red overload LED: steady on when $I > 105\% I_r$.
- Screen that indicate an earth leakage fault trip - reset when product is powered.

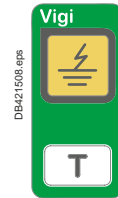

Alarming and Fault Differentiation

A side module SDx can be installed to provide alarming and fault differentiation:

- Overload alarm ($I > 105\% I_r$)
- Overload trip indication
- Earth leakage alarm ($I_{\Delta n} > 80\%$ threshold)
- Earth leakage trip indication.

This module receives the signal from the MicroLogic electronic trip unit via an optical link and makes it available on the terminal block through NO/NC dry contacts.

The signal is cleared when the circuit breaker is restarted.

For description, see page C-11.



MicroLogic Vigi 4.1

	Ratings (A)	In at 40 °C [1]	25	50	100	160					
	Circuit breaker	ComPacT NSXm	<input checked="" type="radio"/>	<input checked="" type="radio"/>	<input checked="" type="radio"/>	<input checked="" type="radio"/>					
L Long-time protection											
Pick-up (A)		I_r	Value depending on trip unit rating (I_n) and setting on dial								
tripping between 1.05 and 1.20 I_r		$I_n = 25\text{ A}$	$I_r = 10$	11	12	14	16	18	20	22	25
		$I_n = 50\text{ A}$	$I_r = 20$	22	25	28	32	36	40	45	50
		$I_n = 100\text{ A}$	$I_r = 40$	45	50	56	63	70	80	90	100
		$I_n = 160\text{ A}$	$I_r = 63$	70	80	90	100	115	130	145	160
Time delay (s)		t_r	Non-adjustable								
accuracy 0 to -20%			1.5 x I_r	200							
			6 x I_r	8							
			7.2 x I_r	5							
Thermal memory			20 minutes before and after tripping								
S₀ Short-time protection with fixed time delay											
Pick-up (A)		$I_{sd} = I_r \times \dots$	1.5	2	3	4	5	6	7	8	10
accuracy ±15 %											
Time delay (ms)		t_{sd}	Non-adjustable								
		Non-tripping time	20								
		Maximum break time	80								
I Instantaneous protection											
Pick-up (A)		I_i non-adjustable	375	750	1500	2000					
accuracy ±15 %		Non-tripping time	10 ms		5 ms						
		Maximum break time	50 ms								
R Earth leakage protection											
Sensitivity $I_{\Delta n}$ (A)		Adjustable $I_{\Delta n} =$	0.03	0.1	0.3	0.5	1	3	5		
		Type	A and AC						AC		
Time delay Δt (ms)		Adjustable $\Delta t =$	0	60 [2]	150 [2]	500 [2]	1000 [2]				
		Maximum break time (ms)	< 40	< 140	< 300	< 800	< 1500				

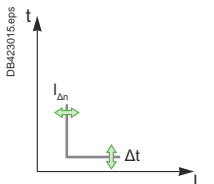
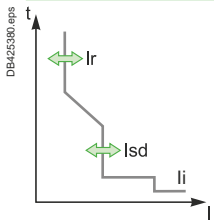

[1] If the circuit breakers are used in high-temperature environments, the setting must take into account the thermal limitations of the circuit breaker.

[2] If the sensitivity is set to 30 mA, there is no time delay, whatever the time-delay setting.

Protection of Distribution Systems

ComPacT NSX MicroLogic Vigi 4 Trip Unit with Integrated Earth Leakage Protection

The ComPacT NSX range is now complemented with a new type of MicroLogic trip unit including both circuit protection and earth leakage protection. It means that the earth leakage protection, previously located within the VigiPacT add-on, will be integrated within the existing size of the MicroLogic trip unit. MicroLogic Vigi 4 is compliant with IEC 60947-2 annex B.

B



MicroLogic Vigi 4 (LS₀IR)



MicroLogic Vigi 4 AL (LS₀I + Earth Leakage Alarm)

MicroLogic Vigi 4

There are two versions of MicroLogic Vigi 4:

- Distribution protection including Earth Leakage Protection (LS₀IR)
- Distribution protection including Earth Leakage Alarm (LS₀I + Earth Leakage Alarm).

Protections

Settings are made using the rotary dial with fine adjustment capabilities.

Short Circuit and Overload Protections

L Overload: Long-Time Protection (I_r)

Inverse time protection against overload with an adjustable current pick-up I_r set using a dial and a non-adjustable time delay t_r.

S Short-Circuit: Short-Time Protection with Fixed Time Delay (I_{sd})

That protection is set with an adjustable pick-up I_{sd}. The tripping takes place after a very short time used to allow selectivity with downstream devices.

I Short Circuit: Non-Adjustable Instantaneous Protection

Instantaneous Short-Circuit Protection with a Fixed Pick-up.

Neutral Protection

- On a 3-pole device, neutral protection is not possible
- On a 4-pole device, neutral protection may be set using the dedicated coding wheel to meet the following configurations: 4P 3D, 4P 3D + N/2 or 4P 4D (same as for MicroLogic 2).

R Earth Leakage Protections

Adjustable leakage threshold (I_{Δn}) and adjustable time delay threshold (Dt) by using the two dials on the green area of the trip unit.

Power Supply

The trip unit is self supplied, and so does not need any external source. It works even when fed by 2 phases only.

Sensitivity I_{Δn} (A)

- Type A: 30mA - 100mA - 300mA - 500mA - 1A - 3A - 5A (for the ratings 40 to 250A)
- Type A: 300mA - 500mA - 1A - 3A - 5A - 10A (for the ratings 400 to 570A).

Caution: "OFF" setting of I_{Δn} is possible. It cancels the earth leakage protection, in that case, the circuit breaker with MicroLogic Vigi 4 behaves as a standard circuit breaker. That "OFF" position is located on the highest side of the coding wheel.

Intentional Delay I_{Δt} (S)

- Case I_{Δn} = 30mA: Δt 0 sec (whatever the setting)
- Case I_{Δn} > 30mA: Δt 0 – 60ms – 150ms – 500ms – 1sec (by setting)

Operated Voltage

200 to 440 VAC (only) – 50/60 Hz

Operating Safety

The earth leakage protection is a user safety device. It must be regularly tested using the test button (T) that simulates a real current leakage within the toroid. When I_{Δn} is set on the OFF position, press the T will cancel any test.

As for standard circuit breaker, the circuit breaker with MicroLogic Vigi 4 can be reset after any fault by operating an OFF/ON procedure.

Specific for the circuit breaker with MicroLogic Vigi 4 Alarm (AL), after testing as well as after a real leakage fault, it can be reset by pressing more than 3 seconds the test button (T), to avoid switching OFF the device.

Protection of Distribution Systems

ComPacT NSX MicroLogic Vigi 4 Trip Unit with Integrated Earth Leakage Protection

Indications

Front Indications

- Green "Ready" LED: flashes slowly when the circuit breaker is ready to trip in case of a fault.
- Orange overload pre-alarm LED: steady ON when $I > 90\% I_r$.
- Red overload LED: steady ON when $I > 105\% I_r$.
- Yellow Screen: indicates an earth leakage fault (reset when operating OFF/ON for the "trip" or when pressing >3sec the T button for the Alarm).

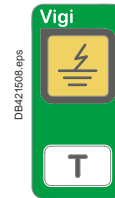

Alarming and Fault Differentiation

- An overload trip signal can be remotely available by installing an SDx relay module inside the circuit breaker on both "trip" and "alarm" versions.
- An earth leakage trip signal can be remotely available by installing an SDx module, only on the "trip" version.
- An earth leakage alarm signal (MicroLogic Vigi 4 AL) can be remotely available on the SDx, for the circuit breaker with MicroLogic Vigi 4 alarm".

This module receives the signal from the MicroLogic trip unit via an optical link and makes it available on the terminal block. The signal is reset when the breaker is operated.

MicroLogic Vigi 4

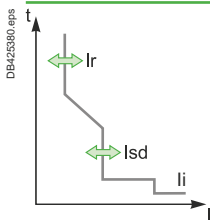

Ratings (A)	In at 40 °C [1]	40	100	160	250	400	570
Circuit breaker	ComPacT NSX100	●	●				
	ComPacT NSX160	●	●	●			
	ComPacT NSX250	●	●	●	●		
	ComPacT NSX400					●	
	ComPacT NSX630					●	●

L Long-time protection

Pick-up (A) tripping between 1.05 and 1.20 Ir	lo	Value depending on the rating (In) and the dial setting								
	In = 40 A	lo = 18	18	20	23	25	28	32	36	40
	In = 100 A	lo = 40	45	50	55	63	70	80	90	100
	In = 160 A	lo = 63	70	80	90	100	110	125	150	160
	In = 250 A	lo = 100	110	125	140	160	175	200	225	250
	In = 400 A	lo = 160	180	200	230	250	280	320	360	400
	In = 570 A	lo = 250	280	320	350	400	450	500	570	570
	Ir = lo x	9 fine adjustment settings from 0.9 to 1 (0.9 – 0.92 ... 0.98 - 1)								
Time delay (s) accuracy 0 to -20%	tr	Non-adjustable								
	at	1.5 x Ir	tr = 400 s							
	at	6 x Ir	tr = 16 s							
	at	7.2 x Ir	tr = 11 s							
Thermal memory		20 minutes before and after tripping								

S₀ Short-time protection with fixed time delay

Pick-up (A) accuracy ±10 %	Isd = Ir x ...	1.5	2	3	4	5	6	7	8	10
Time delay (ms)	tsd	Non-adjustable								
	Non-tripping time	20								
	Maximum break time	80								

I Instantaneous protection

Pick-up (A) accuracy ±15 %	li non-adjustable	600	1500	2400	3000	4800	6900			
	Non-tripping time	10 ms								
	Maximum break time	50 ms								

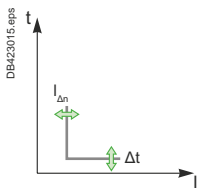

R Earth leakage protection/Earth leakage alarm

Sensitivity (A)	Type A, adjustable (9 positions)									
	In = 40 A	Idn = 0.03	0.03	0.1	0.3	0.5	1	3	5	OFF
	In = 100 A	Idn = 0.03	0.03	0.1	0.3	0.5	1	3	5	OFF
	In = 160 A	Idn = 0.03	0.03	0.1	0.3	0.5	1	3	5	OFF
	In = 250 A	Idn = 0.03	0.03	0.1	0.3	0.5	1	3	5	OFF
	In = 400 A	Idn = 0.3	0.3	0.5	1	3	5	10	10	OFF
	In = 570 A	Idn = 0.3	0.3	0.5	1	3	5	10	10	OFF
Time delay Δt (ms)	Adjustable	Δt = 0	60 [2]	150 [2]	500 [2]	1000 [2]				
	Maximum break time (ms)	<40	<140	<300	<800	<1500	ms			

[1] For the use in high temperature environment, take into account the thermal limitation of the breaker.

[2] The time delay (Δt) is mandatory and forced to "Δt = 0" when the Idn dial is set on 30mA (0.03). The time delay has no effect when the dial Idn is set to the "OFF" position.



Protection of Distribution Systems

ComPacT NSX MicroLogic Vigi 7 E Trip Unit with Integrated Earth Leakage Protection

The ComPacT NSX range is now complemented with a new type of MicroLogic trip unit including circuit protection, metering and earth leakage protection. It means that the earth leakage protection, previously located within the VigiPacT add-on, will be integrated within the existing size of the MicroLogic trip unit. MicroLogic Vigi 7 E is compliant with IEC 60947-2 annex B.

B

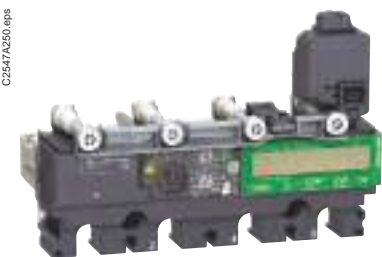

MicroLogic Vigi 7 E (LSIR)



MicroLogic Vigi 7 E AL (LSI + Earth Leakage Alarm)

MicroLogic Vigi 7 E

There are two versions of MicroLogic Vigi 7 E:

- Distribution protection including Earth Leakage Protection (LSIR)
- Distribution protection including Earth Leakage Alarm (LSI + Earth Leakage Alarm).

Locking Protection - Parameter Settings

Settings are made using the rotary dial or/and the keypad. The protection parameter settings are locked when the transparent cover is closed and sealed to avoid access to the adjustment dials and the locking/unlocking microswitch. But you can display the various parameters using the keypad even when the cover is closed (and sealed).

Short Circuit and Overload Protections

L Overload: Long Time Protection (I_r)

Inverse time protection against overload with an adjustable current pick-up I_r set using the dial or the keypad for fine adjustments. The adjustable time delay t_r is set using the keypad only.

S Short-Circuit: Short Circuit Protection (I_{sd})

That protection is with an adjustable pick-up I_{sd} and an adjustable time delay t_{sd} . It is possible to include a portion of an inverse time curve (I^2t On).

I Short Circuit: Instantaneous Protection (I_i)

Instantaneous protection with an adjustable protection pick-up I_i .

Neutral Protection

- On a 4-pole device, the neutral protection may be set using the dedicated coding wheel to meet the following configurations: 4P 3D, 4P 3D + N/2 or 4P 4D (same as for MicroLogic 5).
- OSN (Oversized Neutral Protection) at 1.6 times the phase pick-up value; useful where there is an high level of 3rd order harmonics (or multiple of 3) that create an over-current within the neutral. In that case the device has to be limited to $I_r = I_n \times 0.63$ (for each phase) to allow the neutral protection setting to 1.6 x I_r .

R Earth Leakage Protections

Adjustable leakage threshold ($I_{\Delta n}$) using the dial only (without any use of the keypad for fine-tuning) and an adjustable time delay threshold (Δt) using the keypad only.

Power Supply

The MicroLogic trip unit is powered with its own current for continuous protection functions.

If there is no optional external 24 VDC power supply, the MicroLogic trip unit only works when the circuit breaker is closed. When the circuit breaker is open or the through current is low (15 to 50 A depending on the rating), the MicroLogic trip unit is no longer powered and its display switches off.

An external 24 VDC power supply for the MicroLogic trip unit is optional for:

- Modifying the setting values when the circuit breaker is open
- Displaying measurements when there is a low current through the circuit breaker (15 to 50 A depending on the rating) when the circuit breaker is closed
- Continuing to display the reason for the trip and the breaking current when the circuit breaker is open.

Sensitivity $I_{\Delta n}$ (A)

- Type A: 30mA - 100mA - 300mA - 500mA - 1A - 3A - 5A (for the ratings 40 to 250A)
- Type A: 300mA - 500mA - 1A - 3A - 5A - 10A (for the ratings 400 to 570A)

Caution: "OFF" setting of $I_{\Delta n}$ is possible, it cancels the earth leakage protection, in that case, the circuit breaker with MicroLogic Vigi 4 behaves as a standard circuit breaker. "OFF" position is located on the highest side of the coding wheel.

Protection of Distribution Systems

ComPacT NSX MicroLogic Vigi 7 E Trip Unit with Integrated Earth Leakage Protection

Intentional Delay $I\Delta t$ (S)

- Case $I\Delta n = 30\text{mA}$: Δt 0 sec
- Case $I\Delta n > 30\text{mA}$: Δt 0 – 60ms – 150ms – 500ms – 1sec

Operated Voltage

200 to 440 VAC (only) – 50/60 Hz

Operating Safety

The earth leakage protection is a user safety device. It must be regularly tested using the test button (T) that simulates a real current leakage within the toroid. When $I\Delta n$ is set on the OFF position, press the T will cancel any test. As for the standard circuit breaker, the circuit breaker with MicroLogic Vigi 7 E ("Trip" or "Alarm" version) can be reset after any fault by using the keypad.

The MicroLogic Vigi 7 E allows you to set-up a specific "(T) test without tripping" procedure using the keypad.

Display of the Type of Fault

On a trip, the root cause of the fault (phase and interrupted current) is displayed. An external power supply is needed for this function.

Protection of Distribution Systems

ComPacT NSX MicroLogic Vigi 7 E Trip Unit with Integrated Earth Leakage Protection



B

Indications

Front Indication

- Green "Ready" LED: flashes slowly when the circuit breaker is ready to trip in case of a fault.
- Orange overload pre-alarm LED: steady ON when $I > 90\% I_r$.
- Red overload LED: steady ON when $I > 105\% I_r$.

Written on keypad: earth leakage fault indication (reset using the keypad) for both "Trip" and "Alarm".

Alarming and Fault Differentiation

An SDx relay module can be installed inside the earth leakage circuit breaker to remotely access to the following data:

- Overload pre-Alarm
- Overload trip
- Earth leakage pre-alarm (useful for the "trip" version of the circuit breaker with MicroLogic Vigi 7 E only)
- Earth leakage trip (exist for the "trip" version of the circuit breaker with MicroLogic Vigi 7 E only)
- Earth leakage Alarm without "trip" (circuit breaker with MicroLogic Vigi 7 E AL version only).

This module receives the signal from the MicroLogic electronic trip unit via an optical link and makes it available on the terminal block. The signal is reset when the breaker is operated.

These outputs can be reprogrammed to be assigned to other types of tripping or alarm. The module is deeper described in the section dealing with accessories.

Protection of Distribution Systems

ComPacT NSX MicroLogic Vigi 7 E Trip Unit with Integrated Earth Leakage Protection

MicroLogic Vigi 7 E

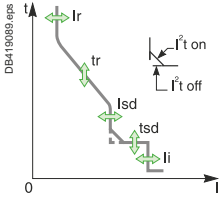

Ratings (A)	In at 40 °C [1]	40 [2]	100	160	250	400	570
Circuit breaker	ComPacT NSX100	●	●				
	ComPacT NSX160	●	●	●			
	ComPacT NSX250	●	●	●	●		
	ComPacT NSX400					●	
	ComPacT NSX630					●	●

L Long-time protection

Pick-up (A)	Dial setting	Value depending on the rating (In) and the dial setting									
tripping between 1.05 and 1.20 Ir	Ir	In = 40 A	lo = 18	18	20	23	25	28	32	36	40
	In = 100 A	lo = 40	45	50	55	63	70	80	90	100	
	In = 160 A	lo = 63	70	80	90	100	110	125	150	160	
	In = 250 A	lo = 100	110	125	140	160	175	200	225	250	
	In = 400 A	lo = 160	180	200	230	250	280	320	360	400	
	In = 570 A	lo = 250	280	320	350	400	450	500	570	570	
	Keypad setting	Fine adjustment in 1A step below the max value set on the dial									
Time delay (s) accuracy 0 to -20%	tr	Keypad setting	0.5	1	2	4	8	16			
	at 1.5 x Ir	15	25	50	100	200	400				
	at 6 x Ir	0.5	1	2	4	8	16				
	at 7.2 x Ir	0.35	0.7	1.4	2.8	5.5	11				
Thermal memory	20 minutes before and after tripping										

S Short-time protection with adjustable time delay

Pick-up (A) accuracy ±10 %	Isd = Ir x ... keypad settings	Adjustment in steps of 0.5 x Ir over the range 1.5 x Ir to 10 x Ir									
Time delay (ms)	tsd	I ² Of	0	0.1	0.2	0.3	0.4				
	Keypad	I ² On	-	0.1	0.2	0.3	0.4				
	Non-tripping time (ms)		20	80	140	230	350				
	Maximum break time		80	140	200	320	500				

I Instantaneous protection

Pick-up (A) accuracy ±15 %	Ii = In x	Adjustment in steps of 0.5 x In over the range 1.5 x In to:									
	Keypad settings	15 x In (40 to 160A), 12 x In (250 to 400A), or 12 x In (570A)									
	Non-tripping time	10 ms									
	Maximum break time	50 ms									

R Earth leakage protection/Earth leakage alarm

Sensitivity (A)	Type A, adjustable (9 positions)										
	In = 40 A	IΔn = 0.03	0.03	0.1	0.3	0.5	1	3	5	OFF	
	In = 100 A	IΔn = 0.03	0.03	0.1	0.3	0.5	1	3	5	OFF	
	In = 160 A	IΔn = 0.03	0.03	0.1	0.3	0.5	1	3	5	OFF	
	In = 250 A	IΔn = 0.03	0.03	0.1	0.3	0.5	1	3	5	OFF	
	In = 400 A	IΔn = 0.3	0.3	0.5	1	3	5	10	10	OFF	
	In = 570 A	IΔn = 0.3	0.3	0.5	1	3	5	10	10	OFF	
Time delay Δt (ms)	Adjustable keypad Δt =	0	60 [3]	150 [3]	500 [3]	1000 [3]					
	Maximum break time (ms)	<40	<140	<300	<800	<1500					

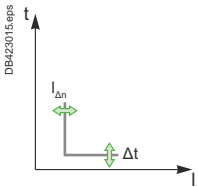

[1] For the use in high temperature environment, take into account the thermal limitation of the breaker.

[2] For the rating 40A, the N/2 adjustment is not possible

[3] The time delay (Δt) is mandatory and designed "Δt = 0" when the IΔn dial is set on 30mA (0.03). The time delay has no effect when the dial IΔn is set to the "OFF" position.



Protection of Distribution Systems

ComPacT NSX VigiPacT Add-on

Protection Against Insulation Faults

B

There are three ways to add earth-leakage protection and alarm to any three pole or four pole ComPacT NSX circuit breaker equipped with magnetic, thermal-magnetic or Micrologic 2, 5, 6 trip units:

- Upgrade the existing trip unit without changing the basic frame to embedded earth-leakage protection by using Micrologic 4 or 7 trip units.
- Add a VigiPacT add-on to the circuit breaker.
- Use an external VigiPacT relay and separate toroids.



ComPacT NSX and MicroLogic 4 and 7



ComPacT NSX and VigiPacT add-on

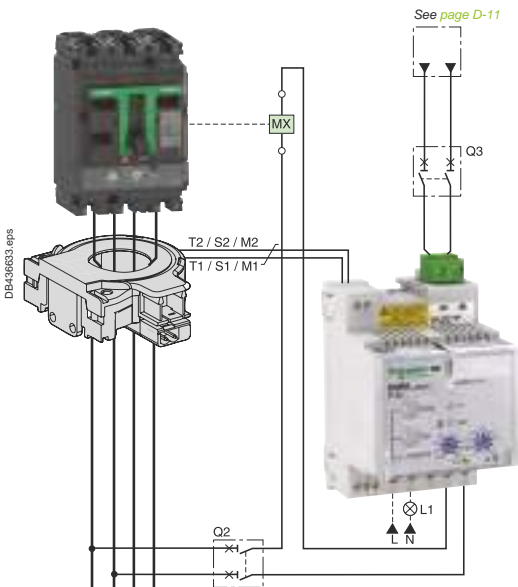

ComPacT NSX with VigiPacT external relay and toroid

Circuit Breaker with Embedded Earth-Leakage Protection Micrologic 4&7

Earth leakage protection integrated within the existing size of the MicroLogic trip unit and compliant with IEC 60947-2 annex B.

Circuit Breaker with VigiPacT Add-on

- For general characteristics of circuit breakers, see pages A-6 and A-7
- VigiPacT add-on

Earth-leakage protection is achieved by installing a VigiPacT add-on (characteristics and selection criteria on next page) directly on the circuit breaker terminals. It directly actuates the trip unit (magnetic, thermal-magnetic or MicroLogic).

ComPacT NSX Circuit Breaker with a VigiPacT Relay

VigiPacT relays may be used to add external earth-leakage protection to ComPacT NSX circuit breakers.

The circuit breakers must be equipped with an MN or MX voltage release. The VigiPacT relays add special tripping thresholds and time delays for earth-leakage protection.

VigiPacT relays are very useful when faced with major installation constraints (circuit breaker already installed and connected, limited space available, etc.).

VigiPacT relay characteristics

- Sensitivity adjustable from 30 mA to 30 A and time-delay settings (0 to 4.5 seconds)
- Closed toroids up to 630 A (30 to 300 mm in diameter), opened toroids up to 250 A (80 to 120 mm in diameter) or rectangular sensors up to 630 A
- 50/60 Hz distribution systems

Relay types

- Type A: up to 5A (RH10, RH21, RH68, RH86, RH99, RH197, RHUs or RHU, RMH) and RHB
- Type AC: RH10, RH21, RH68, RH86, RH99, RH197, RHUs or RHU, RMH
- Type B: RHB

Options

- Trip indication by a fail-safe contact
- Pre-alarm contact and LED, etc.

Compliance with standards

- IEC 60947-2, annex M
- IEC/EN 60755: general requirements for residual-current operated protective devices
- IEC/EN 61000-4-2 to 4-6: immunity tests
- CISPR 11: Industrial, scientific and medical equipment - Radio-frequency disturbance characteristics - Limits and methods of measurement
- UL 1053 and CSA22.2 No. 144 for RH10, RH21 and RH99 relays at supply voltages up to and including 220/240 V.

Protection type

VigiPacT devices operate on TT, TNS and IT (for protection of persons against direct contact) systems.

The relays are type A, AC and B as defined by standard IEC/EN 60947-2.

Protection of Distribution Systems

ComPacT NSX VigiPacT Add-on

Protection Against Insulation Faults

ComPacT NSX VigiPacT Add-on

Addition of the VigiPacT add-on does not modify circuit-breaker characteristics:

- Compliance with standards
- Degree of protection, class II front-face insulation
- Positive contact indication
- Electrical characteristics
- Trip unit characteristics
- Installation and connection modes
- Indication, measurement and control auxiliaries
- Installation and connection accessories.

Dimensions and weights		NSX100/160/250	NSX400/630
Dimensions	3 poles	105 x 236 x 86	140 x 355 x 110
W x H x D (mm)	4 poles	140 x 236 x 86	185 x 355 x 110
Weight (kg)	3 poles	2.5	8.8
	4 poles	3.2	10.8

Compliance with standards

- IEC 60947-2, annex B
- IEC 60755, Type A, immunity to DC components up to 6 mA
- Operation down to -25 °C as per VDE 664

Remote indications

VigiPacT add-on may be equipped with an auxiliary contact (SDV) to remotely signal tripping due to an earth fault.

Use of 4-pole VigiPacT add-on with a 3-pole ComPacT NSX

In a 3-phase installation with an uninterrupted neutral, an accessory makes it possible to use a 4-pole VigiPacT add-on with connection of the neutral cable.

Power supply

VigiPacT add-on are self-powered internally by the distribution-system voltage and therefore do not require any external source. They continue to function even when supplied by only two phases.

ComPacT NSX VigiPacT Add-on		
Type	Protection	Alarm
Number of poles	3, 4	3, 4
Ratings (A)	100, 160, 250, 400, 630	100, 160, 250, 400, 630
I Δ n (A) Class A	0.03, 0.1, 0.3, 0.5, 1, 3 (0.03, 0.06, 0.25, 0.375, 0.5, 3) ^[1]	0.03, 0.1, 0.3, 0.5, 1, 3 -
I Δ n (A) Class AC	10, 30	10, 30
Time delay (ms)	0, 60, 150, 300, 500, 800, 1.2s, 4s	no settings 0 ms
Max break time (ms)	<40 ^[2] <150 ^[2] <500 <800 <1.2s <5s	-
Rated voltages V AC 50/60Hz	200 - 440 440 - 550	200 - 440

[1] Special settings for South Africa.

[2] Max break time according to IEC 60947-2 Annex B Clause B.4.2.4.

Longer time (<+20ms) may be experienced in case of closing on residual current (Clause B.8.2.4.5).



PE121561-6pps

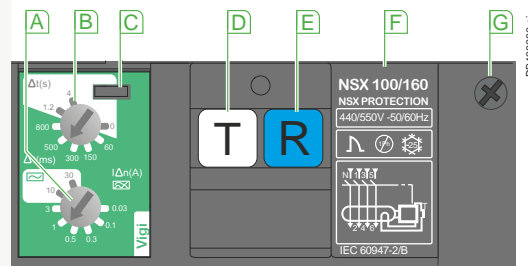

DE439280-ai



- A** Sensitivity setting
- B** Time-delay setting (for selective earth-leakage protection)
- C** Lead-seal fixture for controlled access to settings
- D** Test button simulating an earth-fault for regular checks on the tripping function
- E** Reset button (reset required after earth-fault tripping)
- F** Rating plate
- G** Housing for SDV auxiliary contact

Plug-in devices

The VigiPacT add-on can be installed on a plug-in base. Special accessories are required (see Catalog Numbers chapter).

Select Protection

Protection of Distribution Systems

ComPacT NSX and NSXm

Protection Against Insulation Faults Using a VigiPacT Relay

Detection

with Associated Toroid



Alarm

with the VigiPacT Relay



Protection

with the Circuit-Breaker



Function

VigiPacT relays measure the earth-leakage current in an electrical installation via their associated toroids.

VigiPacT relays may be used for:

- Residual-current protection (RH10, RH21, RH68, RH86, RH99, and RHB)
- Earth-leakage monitoring (RMH or RH99, and RHB)
- Residual-current protection and earth-leakage monitoring (RH197, RHUs, RHU, and RHB).

Residual-Current Protection Relay

Protection relays control the interruption of the supply of power to the monitored systems to help protect:

- People against indirect contact and, in addition, against direct contact
- Property against fire hazards
- Motors.

A relay trips the associated circuit breaker when the set residual operating current $I_{\Delta n}$ is overrun.

Depending on the relay, the threshold $I_{\Delta n}$ can be fixed, user-selectable or adjustable and the overrun can be signalled by a digital display of the measured current or a LED.

The leakage current is displayed:

- For the RH197, on a bargraph made up of 4 LEDs indicating levels corresponding to 20, 30, 40 and 50 % of $I_{\Delta n}$
- For the RHUs and RHU, by digital display of the value of the leakage current.

Circuit breaker tripping can be either instantaneous or delayed. On some relays, it is possible to adjust the time delay.

The protection relays store the residual-current fault in memory. Once the fault has been cleared and the output contact has been manually reset, the relay can be used again.

Earth-Leakage Monitoring Relays

These relays may be used to monitor drops in electrical insulation due to ageing of cables or extensions in the installation.

Continuous measurement of leakage currents makes it possible to plan preventive maintenance on the faulty circuits. An increase in the leakage currents may lead to a complete shutdown of the installation.

The control signal is issued by the relay when the residual-current operating threshold is overrun.

Depending on the relay, the threshold can be adjustable or user-selectable and the overrun can be signalled via a LED, a bargraph or a digital display of the measured current.

The leakage current is displayed:

- For the RH197, on a bargraph made up of 4 LEDs indicating levels corresponding to 20, 30, 40 and 50 % of $I_{\Delta n}$
- For the RMH, by digital display of the value of the leakage current.

The control signal can be either instantaneous or delayed. On some relays, it is possible to adjust the time delay.

Earth-leakage monitoring relays do not store the residual-current fault in memory and their output contact is automatically reset when the fault is cleared.

Use

VigiPacT relays may be used for protection and maintenance at all levels in the installation. Depending on the relays, they may be used in TT, IT or TNS low-voltage AC installations for voltages up to 1000 V and frequencies 50/60 Hz. VigiPacT protection relays are suitable for use with all electrical switchgear devices available on the market.

Protection of Distribution Systems

ComPacT NSX and NSXm

Protection Against Insulation Faults Using a VigiPacT Relay

Developed to be suitable for all installation systems, the VigiPacT range provides real simplicity of choice and assembly.

Overview of the VigiPacT Range

Protection and Monitoring Relays

Device					
	RH10M&P	RH21M&P	RH68M&P	RH86M&P	RHUs/RHU
Functions					
Protection	<input checked="" type="checkbox"/>	<input checked="" type="checkbox"/>	<input checked="" type="checkbox"/>	<input checked="" type="checkbox"/>	<input checked="" type="checkbox"/>
Monitoring	-	-	-	-	<input checked="" type="checkbox"/>
Local indications	<input checked="" type="checkbox"/>	<input checked="" type="checkbox"/>	<input checked="" type="checkbox"/>	<input checked="" type="checkbox"/>	<input checked="" type="checkbox"/>
Type	A	up to 5 A	up to 5 A	up to 5 A	up to 5 A
	AC	<input checked="" type="checkbox"/>	<input checked="" type="checkbox"/>	<input checked="" type="checkbox"/>	<input checked="" type="checkbox"/>
Remote indications	Hard-wired	<input checked="" type="checkbox"/>	<input checked="" type="checkbox"/>	<input checked="" type="checkbox"/>	<input checked="" type="checkbox"/>
	Via com Modbus SL	-	-	-	<input checked="" type="checkbox"/> Except RHUs
Display of measurement	<input checked="" type="checkbox"/>	<input checked="" type="checkbox"/>	<input checked="" type="checkbox"/>	<input checked="" type="checkbox"/>	<input checked="" type="checkbox"/>

B

Protection and Monitoring Relays

Centralized Monitoring Relay

Device					
	RH99M&P	RH197M&P	RHB	RMH	RM12T
Functions					
Protection	-	<input checked="" type="checkbox"/>	<input checked="" type="checkbox"/>	-	-
Monitoring	<input checked="" type="checkbox"/>	<input checked="" type="checkbox"/>	-	<input checked="" type="checkbox"/>	<input checked="" type="checkbox"/>
Local indications	<input checked="" type="checkbox"/>	<input checked="" type="checkbox"/>	<input checked="" type="checkbox"/>	<input checked="" type="checkbox"/>	<input checked="" type="checkbox"/>
Type	A	up to 5 A	up to 5 A	up to 5 A	up to 5 A
	AC	<input checked="" type="checkbox"/>	<input checked="" type="checkbox"/>	<input checked="" type="checkbox"/>	<input checked="" type="checkbox"/>
	B	-	-	-	-
Remote indications	Hard-wired	<input checked="" type="checkbox"/>	<input checked="" type="checkbox"/>	-	<input checked="" type="checkbox"/>
	Via communication	-	-	<input checked="" type="checkbox"/> Except RHUs	<input checked="" type="checkbox"/>
Display of measurement	<input checked="" type="checkbox"/>	<input checked="" type="checkbox"/>	<input checked="" type="checkbox"/>	<input checked="" type="checkbox"/>	<input checked="" type="checkbox"/> 12 measurement channels

Formats for All Installation Systems

Schneider MCB format devices in the VigiPacT range can be mounted on a DIN rail (RH10, RH21, RH99 and RH197) or on a universal mounting plate using mounting lugs (RH10, RH21 and RH99). The 72 x 72 mm front-panel mount devices (RH10, RH21, RH99, RH197, RMH, RHUs and RHU) are mounted on panels, doors or front plates using clips.

Installation System	Suitable Format	
	Front-panel mount	DIN rail
Main LV switchboard	<input checked="" type="checkbox"/>	
Power distribution switchboard	Instrument zone	<input checked="" type="checkbox"/>
	Modular-device zone	<input checked="" type="checkbox"/>
Motor Control Centre (MCC)		<input checked="" type="checkbox"/> With clip-in toroid
Automatic control panel or machine panel		<input checked="" type="checkbox"/> With mounting lugs
Final distribution enclosures		<input checked="" type="checkbox"/>

ComPacT NSX Motor Protection

General Information on Motor Feeders

B

The parameters to be considered for motor-feeder protection depend on:

- The application (type of machine driven, operating safety, frequency of operation, etc.)
- The level of continuity of service required by the load or the application
- The applicable standards for the protection of life and property.

The required electrical functions are:

- Isolation
- Switching, generally at high endurance levels
- Protection against overloads and short-circuits, adapted to the motor
- Additional special protection

A motor feeder must comply with the requirements of standard IEC 60947-4-1 concerning contactors and their protection:

- Coordination of feeder components
- Thermal-relay trip classes
- Contactor utilization categories
- Coordination of insulation

Motor-Feeder Function

A motor feeder comprises a set of devices for motor protection and control, as well as for protection of the feeder itself.

Isolation

The purpose is to isolate the live conductors from the upstream distribution system to enable work by maintenance personnel on the motor feeder at no risk. This function is provided by a motor circuit breaker offering positive contact indication and lockout/tagout possibilities.

Switching

The purpose is to control the motor (ON/OFF), either manually, automatically or remotely, taking into account overloads upon start-up and the long service life required. This function is provided by a contactor. When the coil of the contactor's electromagnet is energized, the contactor closes and establishes, through the poles, the circuit between the upstream supply and the motor, via the circuit breaker.

Basic Protection

- Short-circuit protection
Detection and breaking, as quickly as possible, of high short-circuit currents to avoid damage to the installation. This function is provided by a magnetic or thermal-magnetic circuit breaker.
- Overload protection
Detection of overload currents and motor shutdown before temperature rise in the motor and conductors damages insulation. This function is provided by a thermal-magnetic circuit breaker or a separate thermal relay.

Overloads: $I < 10 \times I_n$

They are caused by:

- An electrical problem, related to an anomaly in the distribution system (e.g. phase failure, voltage outside tolerances, etc.)
- A mechanical problem, related to a process malfunction (e.g. excessive torque) or damage to the motor (e.g. bearing vibrations).

These two causes will also result in excessively long starting times.

Impedant short-circuits: $10 \times I_n < I < 50 \times I_n$

This type of short-circuit is generally due to deteriorated insulation of motor windings or damaged supply cables.

Short-circuits: $I > 50 \times I_n$

This relatively rare type of fault may be caused by a connection error during maintenance.

- Phase unbalance or phase loss protection
Phase unbalance or phase loss can cause temperature rise and braking torques that can lead to premature ageing of the motor. These effects are even greater during starting, therefore protection must be virtually immediate.

Additional Electronic Protection

- Locked rotor
- Under-load
- Long starts and stalled rotor
- Insulation faults

Motor-Feeder Solutions

IEC 60947 defines three types of device combinations for the protection of motor feeders.

Three devices

- Magnetic circuit breaker + contactor + thermal relay

Two devices

- Thermal-magnetic circuit breaker + contactor

One device

- Thermal-magnetic circuit breaker + contactor in an integrated solution (e.g. TeSys U)

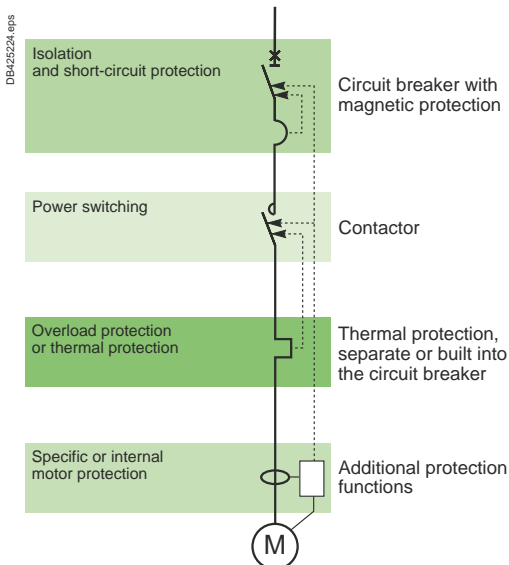
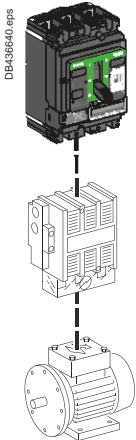

Switchgear functions in a motor feeder

ComPacT NSX Motor Protection

General Information on Motor Feeders



Device Coordination

The various components of a motor feeder must be coordinated. Standard IEC 60947-4-1 defines three types of coordination depending on the operating condition of the devices following a standardized short-circuit test.

Type 1 coordination

- No danger to life or property
- The contactor and/or the thermal relay may be damaged
- Repair and replacement of parts may be required prior to further service

Type 2 coordination

- No danger to life or property
- No damage or adjustments are allowed. The risk of contact welding is accepted as long as they can be easily separated
- Isolation must be maintained after the incident, the motor feeder must be suitable for further use without repair or replacement of parts
- A rapid inspection is sufficient before return to service

Total coordination

No damage and no risk of contact welding is allowed for the devices making up the motor feeder. The motor feeder must be suitable for further use without repair or replacement of parts.

This level is provided by integrated 1-device solutions such as TeSys U.

Contactor Utilization Categories

For a given motor-feeder solution, the utilization category determines the contactor withstand capacity in terms of frequency of operation and endurance. Selection, which depends on the operating conditions imposed by the application, may result in oversizing the contactor and circuit-breaker protection. IEC 60947 defines the following contactor utilization categories.

Contactor utilization categories (AC current)

Contactor utilization categories	Type of load	Control function	Typical applications
AC-1	Non-inductive ($\cos \varphi \geq 0.8$)	Energizing	Heating, distribution
AC-2	Slip-ring motor ($\cos \varphi \geq 0.65$)	Starting Switching off motor during running Counter-current braking Inching	Wiring-drawing machine
AC-3	Squirrel-cage motor ($\cos \varphi = 0.45$ for ≤ 100 A) ($\cos \varphi = 0.35$ for > 100 A)	Starting Switching off motor during running	Compressors, elevators, pumps, mixers, escalators, fans, conveyer systems, air-conditioning
AC-4		Starting Switching off motor during running Regenerative braking Plugging Inching	Printing machines, wire-drawing machines

Utilization category AC-3 - common coordination tables for circuit breakers and contactors

This category covers asynchronous squirrel-cage motors that are switched off during running, which is the most common situation (85 % of cases). The contactor makes the starting current and switches off the rated current at a voltage approximately one sixth of the nominal value. The current is interrupted without difficulty.

The circuit breaker-contactor coordination tables for ComPacT NSX are for use with contactors in the AC-3 utilization category, in which case they ensure type 2 coordination.

Utilization category AC-4 - possible oversizing

This category covers asynchronous squirrel-cage motors capable of operating under regenerative braking or inching (jogging) conditions

The contactor makes the starting current and can interrupt this current at a voltage that may be equal to that of the distribution system.

These difficult conditions make it necessary to oversize the contactor and, in general, the protective circuit breaker with respect to category AC-3.

ComPacT NSX Motor Protection

Motor-Feeder Characteristics and Solutions

The trip class determines the trip curve of the thermal protection device (inverse-time curve) for a motor feeder. Standard IEC 60947-4-1 defines trip classes 5, 10, 20 and 30. These classes are the maximum durations, in seconds, for motor starting with a starting current of $7.2 I_r$, where I_r is the thermal setting indicated on the motor rating plate.

Example: In class 20, the motor must have finished starting within 20 seconds (6 to 20 s) for a starting current of $7.2 I_r$.

Trip Class of a Thermal-Protection Device

The motor feeder includes thermal protection that may be built into the circuit breaker. The protection must have a trip class suited to motor starting. Depending on the application, the motor starting time varies from a few seconds (no-load start) to a few dozen seconds (high-inertia load). Standard IEC 60947-4-1 defines the trip classes below as a function of current setting I_r for thermal protection.

Trip class of thermal relays as a function of their I_r setting

Class	$1.05 I_r$ [1]	$1.2 I_r$ [1]	$1.5 I_r$ [2]	$7.2 I_r$ [1]
5	$t > 2$ h	$t < 2$ h	$t < 2$ mn	$2 \text{ s} < t \leq 5 \text{ s}$
10	$t > 2$ h	$t < 2$ h	$t < 4$ mn	$4 \text{ s} < t \leq 10 \text{ s}$
20	$t > 2$ h	$t < 2$ h	$t < 8$ mn	$6 \text{ s} < t \leq 20 \text{ s}$
30	$t > 2$ h	$t < 2$ h	$t < 12$ mn	$9 \text{ s} < t \leq 30 \text{ s}$

[1] Time for a cold motor (motor off and cold).

[2] Time for warm motor (motor running under normal conditions).

Currents of Squirrel-Cage Motors at Full Rated Load

Standardized values in HP

Rated operational power hp	Indicative values of the rated operational currents I_e (A) for						
	110 - 120 V	200 V	208 V	220 - 240 V	380 - 415 V	440 - 480 V	550 - 600 V
1/2	4.4	2.5	2.4	2.2	1.3	1.1	0.9
3/4	6.4	3.7	3.5	3.2	1.8	1.6	1.3
1	8.4	4.8	4.6	4.2	2.3	2.1	1.7
1 1/2	12	6.9	6.6	6	3.3	3	2.4
2	13.6	7.8	7.5	6.8	4.3	3.4	2.7
3	19.2	11	10.6	9.6	6.1	4.8	3.9
5	30.4	17.5	16.7	15.2	9.7	7.6	6.1
7 1/2	44	25.3	24.2	22	14	11	9
10	56	32.2	30.8	28	18	14	11
15	84	48.3	46.2	42	27	21	17
20	108	62.1	59.4	54	34	27	22
25	136	78.2	74.8	68	44	34	27
30	160	92	88	80	51	40	32
40	208	120	114	104	66	52	41
50	260	150	143	130	83	65	52
60	-	177	169	154	103	77	62
75	-	221	211	192	128	96	77
100	-	285	273	248	165	124	99
125	-	359	343	312	208	156	125
150	-	414	396	360	240	180	144
200	-	552	528	480	320	240	192
250	-	-	-	604	403	302	242
300	-	-	-	722	482	361	289

Note: 1 hp = 0.7457 kW.

Asynchronous-Motor Starting Parameters

The main parameters of direct on-line starting of three-phase asynchronous motors (90 % of all applications) are listed below.

- **I_r** : rated current
This is the current drawn by the motor at full rated load (e.g. approximately 100 A rms for 55 kW at 400 V).
- **I_d** : starting current
This is the current drawn by the motor during starting, on average $7.2 I_n$ for a duration t_d of 5 to 30 seconds depending on the application (e.g. 720 A rms for 10 seconds). These values determine the trip class and any additional "long-start" protection devices that may be needed.
- **I''_d** : peak starting current
This is the subtransient current during the first two half-waves when the system is energized, on the average $14 I_n$ for 10 to 15 ms (e.g. 1840 A peak).

The protection settings must effectively protect the motor, notably via a suitable thermal-relay trip class, but let the peak starting current through.

Standardized values in kW

Rated operational power kW	Standardized values in kW currents I_e (A) for:			
	230 V A	400 V A	500 V A	690 V A
0.06	0.35	0.32	0.16	0.12
0.09	0.52	0.3	0.24	0.17
0.12	0.7	0.44	0.32	0.23
0.18	1	0.6	0.48	0.35
0.25	1.5	0.85	0.68	0.49
0.37	1.9	1.1	0.88	0.64
0.55	2.6	1.5	1.2	0.87
0.75	3.3	1.9	1.5	1.1
1.1	4.7	2.7	2.2	1.6
1.5	6.3	3.6	2.9	2.1
2.2	8.5	4.9	3.9	2.8
3	11.3	6.5	5.2	3.8
4	15	8.5	6.8	4.9
5.5	20	11.5	9.2	6.7
7.5	27	15.5	12.4	8.9
11	38	22	17.6	12.8
15	51	29	23	17
18.5	61	35	28	21
22	72	41	33	24
30	96	55	44	32
37	115	66	53	39
45	140	80	64	47
55	169	97	78	57
75	230	132	106	77
90	278	160	128	93
110	340	195	156	113
132	400	230	184	134
160	487	280	224	162
200	609	350	280	203
250	748	430	344	250
315	940	540	432	313

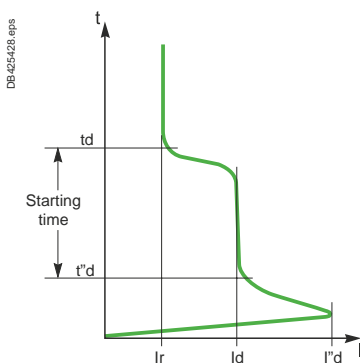

Typical motor-starting curve

ComPacT NSX Motor Protection Motor-Feeder Solutions

ComPacT NSX motor circuit breakers are designed for motor-feeder solutions using:

- Three devices, including an MA or 1.3 M magnetic-only trip unit
- Two devices including a 2 M or 6 E-M electronic trip units.

They are designed for use with contactors in the AC-3 utilization category (80 % of all cases) and they ensure type 2 coordination with the contactor.

For the AC-4 utilization category, the difficult conditions generally make it necessary to oversize the protection circuit breaker with respect to the AC-3 category.

ComPacT NSX Motor-Protection Range

ComPacT NSX trip units can be used to create motor-feeder solutions comprising two or three devices. The protection devices are designed for continuous duty at 65 °C.





Three-device solutions

- 1 NSX circuit breaker with an MA or MicroLogic 1.3 M trip unit
- 1 contactor
- 1 thermal relay

Two-device solutions

- 1 ComPacT NSX circuit breaker
 - With a MicroLogic 2.2 M or 2.3 M electronic trip unit
 - With a MicroLogic 6 E-M electronic trip unit. This version offers additional protection and power meter functions
- 1 contactor

B

Type of Motor Protection		3 Devices		2 Devices	
ComPacT NSX circuit breaker		NSX100/160/250	NSX400/630	NSX100 to 630	
Trip unit	Type 2 coordination with Type Technology	Contactor + thermal relay MA Magnetic 	MicroLogic 1.3 M Electronic 	Contactor MicroLogic 2 M Electronic 	MicroLogic 6 E-M Electronic 
Thermal relay	Separate	●	●		
	Built-in, class				
	5			●	●
	10			●	●
	20			●	●
	30				●
Protection functions of ComPacT NSX circuit breaker					
Short-circuits		●	●	●	●
Overloads				●	●
Insulation faults	Ground-fault				●
Special motor functions	Phase unbalance			●	●
	Locked rotor				●
	Under-load				●
	Long start				●
Built-in power meter functions					
I, U, energy					●
Operating assistance					
Counters (cycles, trips, alarms, hours)					●
Contact-wear indicator					●
Load profile and thermal image					●

> Discover our specific Motor Protection Offer:

TeSys GV



MKTED210011EN

ComPacT NSX Motor Protection MA Instantaneous Trip Units

MA magnetic trip units are used in 3 devices motor-feeder solutions. They can be mounted on all ComPacT NSX100/160/250 circuit breakers with performance levels B/F/H/N/S/L. They provide short-circuit protection for motors up to 110 kW at 400 V.



B

MA Magnetic Trip Units

In distribution applications, circuit breakers equipped with MA magnetic-only trip units are used for:

- Short-circuit protection of secondary windings of LV/LV transformers with overload protection on the primary side
- As an alternative to a switch-disconnector at the head of a switchboard in order to provide short-circuit protection.

Their main use is however for motor protection applications, in conjunction with a thermal relay and a contactor or motor starter.

Protection

Magnetic Protection (Ii)

Short-circuit protection with an adjustable pick-up Ii that initiates instantaneous tripping if exceeded.

- $I_i = I_n \times \dots$ set in amps on an adjustment dial  covering the range 6 to 14 x In for 2.5 to 100 A ratings or 9 to 14 In for 150 to 220 A ratings.

Protection Versions

- 3-pole (3P 3D): 3-pole frame (3P) with detection on all 3 poles (3D)
- 4-pole (4P 3D): 4-pole frame (4P) with detection on 3 poles (3D)

Magnetic Trip Units MA 2.5 to 220

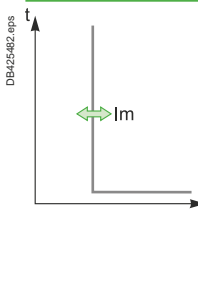
	Ratings (A)	In at 65 °C [1]	2.5	6.3	12.5	25	50	100 [1]	150	220	
	Circuit breaker	ComPacT NSX100	●	●	●	●	●	●	-	-	
		ComPacT NSX160	-	-	-	●	●	●	●	-	
		ComPacT NSX250	-	-	-	-	-	●	●	●	
Instantaneous magnetic protection											
	Pick-up (A) accuracy ±20 %	$I_i = I_n \times \dots$	Adjustable from 6 to 14 x In (settings 6, 7, 8, 9, 10, 11, 12, 13, 14)						Adjustable from 9 to 14 x In (settings 9, 10, 11, 12, 13, 14)		
	Time delay (ms)	tm	fixed								

[1] MA100 3P adjustable from 6 to 14 x In.
MA100 4P adjustable from 9 to 14 x In.

Note: All the trip units have a transparent lead-sealable cover that avoids access to the adjustment dials.

ComPacT NSX Motor Protection MicroLogic 1.3 M Instantaneous Trip Units

MicroLogic 1.3 M trip units are used in 3 devices motor-feeder solutions on ComPacT NSX400/630 circuit breakers with performance levels B/F/H/N/S/L.

They provide short-circuit protection for motors up to 250 kW at 400 V.

They also provide the benefits of electronic technology:

- Accurate settings
- Tests
- "Ready" LED.

MicroLogic 1.3 M Trip Units

Circuit breakers with a MicroLogic 1.3 M trip unit are combined with a thermal relay and a contactor.

Protection

Settings are made using a dial.

Short-Circuits: Short-Time Protection (Isd)

Protection with an adjustable pick-up Isd. There is a very short delay to let through motor starting currents.

- Isd is set in amperes from 5 to 13 x In, as follows:
 - From 1600 to 4160 A for the 320 A rating
 - From 2500 to 6500 A for the 500 A rating

Short-Circuits: Non-Adjustable Instantaneous Protection (Ii)

Instantaneous protection with non-adjustable pick-up Ii.

Protection Version

- 3-pole (3P 3D): 3-pole frame (3P) equipped with detection on all 3 poles (3D).

Indications

Front indications

- Green "Ready" LED: flashes slowly when the circuit breaker is ready to trip in the event of a fault.

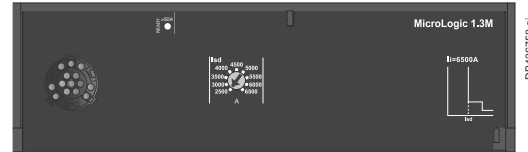

DB42381.tps



MicroLogic 1.3 M

	Ratings (A)	In at 65 °C [1]	320	500
Circuit breaker		ComPacT NSX400	●	-
		ComPacT NSX630	●	●
S Short-time protection				
Pick-up (A) accuracy ±15 %	Isd	Adjustable directly in amps		9 settings: 2500, 3000, 3500, 4000, 4500, 5000, 5500, 6000, 6500 A
Time delay (ms)	tsd	Non-adjustable		
	Non-tripping time	10		
	Maximum break time	60		
I Instantaneous protection				
Pick-up (A) accuracy ±15 %	Ii non-adjustable	4800	6500	
	Non-tripping time	0		
	Maximum break time	30 ms		

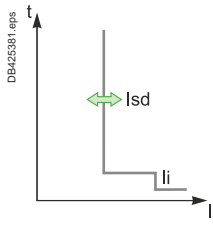

[1] Motor standards require operation at 65 °C. Circuit-breaker ratings are derated to take this requirement into account (see pages E-14 to E-17).

ComPacT NSX Motor Protection

MicroLogic 2.2/2.3 M Electronic Trip Units

MicroLogic 2.2/2.3 M trip units provide built-in thermal and magnetic protection. They are used in 2 devices motor-feeder solutions on ComPacT NSX100 to 630 circuit breakers with performance levels B/F/H/N/S/L. They provide protection for motors up to 315 kW at 400 V against:

- Short-circuits
- Overloads with selection of a trip class (5, 10 or 20)
- Phase unbalance.

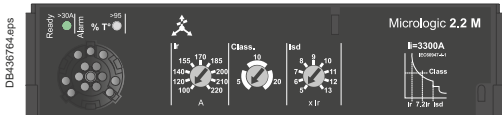

DB436764.eps

B

Circuit breakers with a MicroLogic 2.2/2.3 M trip unit include protection similar to an inverse-time thermal relay. They are combined with a contactor.

Protection

Settings are made using a dial.

L Overloads (or thermal protection): Long-time protection and trip class (Ir)
Inverse-time thermal protection against overloads with adjustable pick-up Ir. Settings are made in amperes. The tripping curve for the long-time protection, which indicates the time delay t_r before tripping, is defined by the selected trip class.

Trip class (class)

The class is selected as a function of the normal motor starting time.

- Class 5: starting time less than 5 s.
- Class 10: starting time less than 10 s.
- Class 20: starting time less than 20 s.

For a given class, it is necessary to check that all motor-feeder components are sized to carry the $7.2 I_r$ starting current without excessive temperature rise during the time corresponding to the class.

S Short-circuits: Short-time protection (Isd)

Protection with an adjustable pick-up Isd. There is a very short delay to let through motor starting currents.

I Short-circuits: Non-adjustable instantaneous protection (Ii)

Instantaneous protection with non-adjustable pick-up Ii.

Phase unbalance or phase loss (Iunbal) (⚡)

This function opens the circuit breaker if a phase unbalance occurs:

- That is greater than the 30 % fixed pick-up Iunbal
- Following the non-adjustable time delay tunbal equal to:
 - 0.7 s during starting
 - 4 s during normal operation.

Phase loss is an extreme case of phase unbalance and leads to tripping under the same conditions.

Indications

Front indications

- Green "Ready" LED: flashes slowly when the circuit breaker is ready to trip in the event of a fault.
- Red alarm LED for motor operation: goes ON when the thermal image of the rotor and stator is greater than 95 % of the permissible temperature rise.

Remote indications via SDTAM module

ComPacT NSX devices with a MicroLogic 2 can be equipped with an SDTAM module dedicated to motor applications for:

- A contact to indicate circuit-breaker overload
- A contact to open the contactor. In the event of a phase unbalance or overload, this output is activated 400 ms before circuit-breaker tripping to open the contactor and avoid circuit breaker tripping.

This module takes the place of the MN/MX coils and an OF contact.



PB103376.eps

SDTAM remote indication relay module with its terminal block

Note: All the trip units have a transparent lead-sealable cover that avoids access to the adjustment dials.

ComPacT NSX Motor Protection

MicroLogic 2.2/2.3 M Electronic Trip Units

MicroLogic 2.2/2.3 M

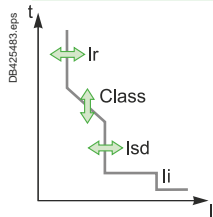

Ratings (A)	In at 65 °C ^[1]	25	50	100	150	220	320	500
Circuit breaker	ComPacT NSX100	●	●	●	-	-	-	-
	ComPacT NSX160	●	●	●	●	-	-	-
	ComPacT NSX250	●	●	●	●	●	-	-
	ComPacT NSX400	-	-	-	-	-	●	-
	ComPacT NSX630	-	-	-	-	-	●	●

L Overloads (or thermal protection): Long-time protection and trip class

Pick-up (A) tripping between 1.05 and 1.20 Ir	Ir	Value depending on trip unit rating (In) and setting on dial								
In = 25 A	Ir =	12	14	16	18	20	22	23	24	25
In = 50 A	Ir =	25	30	32	36	40	42	45	47	50
In = 100 A	Ir =	50	60	70	75	80	85	90	95	100
In = 150 A	Ir =	70	80	90	100	110	120	130	140	150
In = 220 A	Ir =	100	120	140	155	170	185	200	210	220
In = 320 A	Ir =	160	180	200	220	240	260	280	300	320
In = 500 A	Ir =	250	280	320	350	380	400	440	470	500
Trip class as per IEC 60947-4-1		5	10	20						

Time delay (s) depending on selected trip class	tr	1.5 x Ir	240	480	for warm motor						
		6 x Ir	6.5	13.5	26	for cold motor					
		7.2 x Ir	5	10	20	for cold motor					

Thermal memory: 20 minutes before and after tripping

Cooling fan: Non-adjustable - motor self-cooled

S₀ Short-circuits: Short-time protection with fixed time delay

Pick-up (A) accuracy ±15 %	Isd = Ir x ...	5	6	7	8	9	10	11	12	13
Time delay (ms)	tsd	Non-adjustable								
	Non-tripping time	10								
	Maximum break time	60								

I Short-circuits: Non-adjustable instantaneous protection

Pick-up (A) accuracy ±15 %	Ii non-adjustable	425	750	1500	2250	3300	4800	6500	
Time delay (ms)	Non-tripping time	0							
	Maximum break time	30							

Phase unbalance or phase loss

Pick-up (A) accuracy ±20 %	Iunbal in % average current ^[2]	> 30 %
Time delay (s)	Non-adjustable	0.7 s during starting 4 s during normal operation

[1] Motor standards require operation at 65 °C. Circuit-breaker ratings are derated to take this requirement into account (see pages E-14 to E-17).

[2] The unbalance measurement takes into account the most unbalanced phase with respect to the average current.



ComPacT NSX Motor Protection

MicroLogic 6 E-M Electronic Trip Units

MicroLogic 6.E-M is used in 2 devices motor-feeder solutions. It provides the same protection as MicroLogic 2 M:

- Short-circuits
- Overloads with selection of the same trip classes (5, 10 or 20), plus trip class 30 for starting of machines with high inertia.

In addition, it offers specific motor-protection functions that can be set via the keypad.



Protection

The protection can be fine-adjusted via the keypad . Access to setting modifications via the keypad is protected by a locking function that is controlled by a microswitch . The lock is activated automatically if the keypad is not used for 5 minutes. Access to the microswitch is protected by a transparent lead-sealable cover. It is possible to scroll through settings and measurements with the cover closed.

Overloads (or thermal), class and short-circuits

The long-time, short-time and instantaneous functions are identical to those of MicroLogic 2 M.

In addition, there is trip class 30 for long-time protection and a setting for self-cooled or fan-cooled motors ().

Ground-fault protection (I_g)

Residual type ground-fault protection with an adjustable pick-up I_g (with Off position) and adjustable time delay tg.

Phase unbalance or phase loss

This function opens the circuit breaker if a phase unbalance occurs:

- That is greater than the I-unbal pick-up that can be fine-adjusted from 10 to 40 % (30 % by default)
- Following the tunbal time delay that is:
 - 0.7 s during starting
 - Adjustable from 1 to 10 seconds (4 seconds by default) during normal operation.

Phase loss is an extreme case of phase unbalance and leads to tripping under the same conditions.

Locked rotor (I-jam)

This function detects locking of the motor shaft caused by the load.

During motor starting (see page B-37), the function is disabled.

During normal operation, it causes tripping:

- Above the I-jam pick-up that can be fine-adjusted from 1 to 8 x I_r
- In conjunction with the tjam time delay that can be adjusted from 1 to 30 seconds

Under-load (I-und)

This function detects motor no-load operation due to insufficient load (e.g. a drained pump). It detects phase undercurrent.

During motor starting (see page B-37), the function is always enabled.

During normal operation, it causes tripping:

- Below the I-und pick-up that can be fine-adjusted from 0.3 to 0.9 x I_r
- In conjunction with the tund time delay that can be adjusted from 1 to 200 seconds.

Long starts (I-long)

This protection supplements thermal protection (class).

It is used to better adjust protection to the starting parameters.

It detects abnormal motor starting, i.e. when the starting current remains too high or too low with respect to a pick-up value and a time delay.

It causes tripping:

- In relation with a llong pick-up that can be fine-adjusted from 1 to 8 x I_r
- In conjunction with the tlong time delay that can be adjusted from 1 to 200 seconds (see "long starts" page B-37).

Note: All the trip units have a transparent lead-sealable cover that avoids access to the adjustment dials.

ComPacT NSX Motor Protection MicroLogic 6 E-M Electronic Trip Units

Display of Type of Fault

On a fault trip, the type of fault (Ir, Isd, li, Ig, lunbal, ljam), the phase concerned and the interrupted current are displayed.

Indications

Front indications

- Green "Ready" LED: flashes slowly when the circuit breaker is ready to trip in the event of a fault.
- Red alarm LED for motor operation: goes ON when the thermal image of the rotor or stator is greater than 95% of the permissible temperature rise.

Remote indications via SDTAM or SDx module

See description on [page C-31](#) for SDTAM and for SDx.

B

MicroLogic 6.2/6.3 E-M

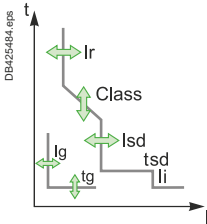

Ratings (A)	In at 65 °C [1]	25	50	80	150	220	320	500
Circuit breaker	ComPacT NSX100	●	●	●	-	-	-	-
	ComPacT NSX160	●	●	●	●	-	-	-
	ComPacT NSX250	●	●	●	●	●	-	-
	ComPacT NSX400	-	-	-	-	-	●	-
	ComPacT NSX630	-	-	-	-	-	●	●

L Overloads: Long-time protection

Pick-up (A)	Ir	Dial setting	Value depending on trip-unit rating (In) and setting on dial									
Tripping between 1.05 and 1.20 Ir		In = 25 A Ir =	12	14	16	18	20	22	23	24	25	
		In = 50 A Ir =	25	30	32	36	40	42	45	47	50	
		In = 80 A Ir =	35	42	47	52	57	60	65	72	80	
		In = 150 A Ir =	70	80	90	100	110	120	130	140	150	
		In = 220 A Ir =	100	120	140	155	170	185	200	210	220	
		In = 320 A Ir =	160	180	200	220	240	260	280	300	320	
		In = 500 A Ir =	250	280	320	350	380	400	440	470	500	
		Keypad setting	Fine adjustments in 1 A steps below maximum value defined by dial setting									
Trip class as per IEC 60947-4-1			5	10	20	30						
Time delay (s) depending on selected trip class	tr	1.5 x Ir	120	240	480	720	for warm motor					
		6 x Ir	6.5	13.5	26	38	for cold motor					
		7.2 x Ir	5	10	20	30	for cold motor					
Thermal memory			20 minutes before and after tripping									
Cooling fan			Settings for self-cooled or fan-cooled motors									

S_n Short-circuits: Short-time protection with fixed time delay

Pick-up (A) accuracy ±15 %	Isd = Ir x ...	5	6	7	8	9	10	11	12	13	
Time delay	tsd	Non-adjustable									
	Non-tripping time	10 ms									
	Maximum break time	60 ms									

I Short-circuits: Non-adjustable instantaneous protection

Pick-up (A) accuracy ±15 %	li non-adjustable	425	750	1200	2250	3300	4800	6500	
	Non-tripping time	0 ms							
	Maximum break time	30 ms							

G Ground faults

Pick-up (A) accuracy ±10 %	Ig = In x ...	Dial setting										
	In = 25 A Ig =	0.6	0.6	0.6	0.6	0.7	0.8	0.9	1	Off		
	In = 50 A Ig =	0.3	0.4	0.5	0.6	0.7	0.8	0.9	1	Off		
	In > 50 A Ig =	0.2	0.3	0.4	0.5	0.6	0.7	0.8	1	Off		
		Fine adjustments in 0.05 x In steps										
Time delay (ms)	tg	0	0.1	0.2	0.3	0.4						
	Non-tripping time	20	80	140	230	350						
	Maximum break time	80	140	200	320	500						

[1] Motor standards require operation at 65 °C. Circuit-breaker ratings are derated to take this requirement into account (see pages E-14 to E-17).

[2] The unbalance measurement takes into account the most unbalanced phase with respect to the average current.

ComPacT NSX Motor Protection

MicroLogic 6 E-M Electronic Trip Units

MicroLogic 6.2 E M/6.3 E M

Phase unbalance or phase loss

Pick-up (A) accuracy $\pm 20\%$	lunbal = in % average current ^[2]	adjustable from 10 to 40 %, default setting = 30 % fine adjustments in 1 % steps using the keypad activated during motor starting
Time delay (s)	tunbal	0.7 s during starting 1 to 10 seconds during normal operation, default setting = 4 seconds fine adjustments in 1 s steps using the keypad

Locked rotor

Pick-up (A) accuracy $\pm 10\%$	ljam = $I_r \times \dots$	1 x 8 I_r with Off position, default setting = Off fine adjustments in 0.1 x I_r steps using the keypad disabled during motor starting
Time delay (s)	tjam =	1 to 30 seconds fine adjustments in 1 s steps using the keypad, default setting = 5 s

Under-load (under-current)

Pick-up (A) accuracy $\pm 10\%$	lund = $I_r \times \dots$	0.3 x 0.9 I_r with Off position, default setting = Off Fine adjustments in $I_r \times 0.01$ steps using the EcoStruxure Power Commission software activated during motor starting
Time delay (s)	tund =	1 to 200 seconds fine adjustments in 1 s steps using the EcoStruxure Power Commission software, default setting = 10 s

Long starts

Pick-up (A) accuracy $\pm 10\%$	llong = $I_r \times \dots$	1 x 8 I_r with Off position, default setting = Off Fine adjustments in $I_r \times 0.1$ steps using the EcoStruxure Power Commission software activated during motor starting
Time delay (s)	tlong =	1 to 200 seconds fine adjustments in 1 s steps using the EcoStruxure Power Commission software, default setting = 10 s

[1] Motor standards require operation at 65 °C. Circuit-breaker ratings are derated to take this requirement into account (see pages E-14 to E-17).

[2] The unbalance measurement takes into account the most unbalanced phase with respect to the average current.

B

ComPacT NSX Motor Protection

Additional Technical Characteristics

Phase unbalance

An unbalance in three-phase systems occurs when the three voltages are not equal in amplitude and/or not displaced 120° with respect to each other. It is generally due to single-phase loads that are incorrectly distributed throughout the system and unbalance the voltages between the phases.

These unbalances create negative current components that cause braking torques and temperature rise in asynchronous machines, thus leading to premature ageing.

Phase loss

Phase loss is a special case of phase unbalance.

- During normal operation, it produces the effects mentioned above and tripping must occur after four seconds.
- During starting, the absence of a phase may cause motor reversing, i.e. it is the load that determines the direction of rotation. This requires virtually immediate tripping (0.7 seconds).

Starting time in compliance with the class (MicroLogic 2 M)

For normal motor starting, MicroLogic 2 M checks the conditions below with respect to the thermal-protection (long-time) pick-up I_r :

- Current $> 10\% \times I_r$ (motor-off limit)
- Overrun of $1.5 \times I_r$ threshold, then return below this threshold before the end of a 10 s time delay.

If either of these conditions is not met, the thermal protection trips the device after a maximum time equal to that of the selected class.

Pick-up I_r must have been set to the current indicated on the motor rating plate.

Long starts (MicroLogic 6 E-M)

When this function is not activated, the starting conditions are those indicated above. When it is activated, this protection supplements thermal protection (class).

A long start causes tripping and is characterized by:

- Current $> 10\% \times I_r$ (motor-off limit) with:
 - Either overrun of the long-time pick-up (1 to $8 \times I_r$) without return below the pick-up before the end of the long-time time delay (1 to 200 s)
 - Or no overrun of the long-time pick-up (1 to $8 \times I_r$) before the end of the long-time time delay (1 to 200 s).

Pick-up I_r must have been set to the current indicated on the motor rating plate. This protection should be coordinated with the selected class.

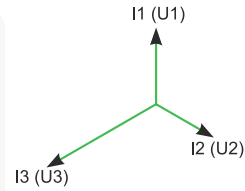

Unbalance of phase currents and voltages

DB425420.eps

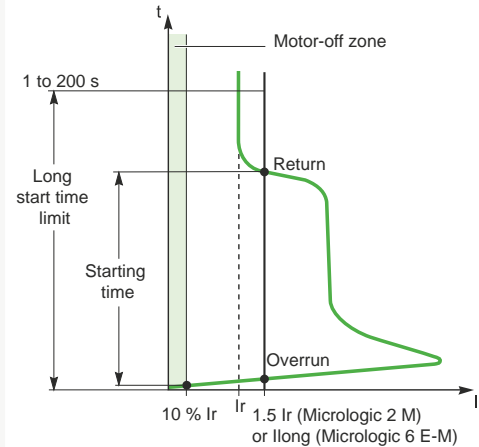

Motor starting and long starts

DB425430.eps



ComPacT NSX Measurement

MicroLogic 5/6/7 E Electronic Trip Units

ComPacT NSX with its embedded current sensors handled by a microprocessor that operates independently of protection functions and MicroLogic 5/6/7 E is a PMD-DD Power Meter Device complying with IEC/EN 61557-12, Class 0.5 for voltage, Class 1 for current and Class 2 for active power and energy measurements.

B

Measures and Electrical Parameters Calculated by the MicroLogic 5/6/7 E Trip Units

Based on the measure of line currents, neutral current, phase to phase voltages and phase to neutral voltages, the MicroLogic 5/6/7 E trip units calculate and display all the parameters required to monitor any AC electrical power supply including power quality, power management and energy efficiency:

- RMS values of currents and voltages
- Active, reactive and apparent powers, active, reactive and apparent energies
- Power factor
- Frequency
- Unbalance on voltage and THD of voltages and currents
- Demand and maximum demand values

The maximum and minimum values are stored in the MicroLogic 5/6/7 E trip units non volatile memory. They are resettable from the embedded display, FDM display or a PC running EcoStruxure Power Commission software.

Demand and Maximum Demand Values

MicroLogic E also calculates demand current and power values. These calculations can be made using a block or sliding interval that can be set from 5 to 60 minutes in steps of 1 minute. The window can be synchronized with a signal sent via the communication system. Whatever the calculation method, the calculated values can be recovered on a PC via Modbus communication.

Ordinary spreadsheet software can be used to provide trend curves and forecasts based on this data. They will provide a basis for load shedding and reconnection operations used to adjust consumption to the subscribed power.

Electrical values can be displayed on the embedded HMI, a PC running EcoStruxure Power Commission software and on the FDM display unit.

They are refreshed every second.

The display on the embedded HMI is accessed by means of a contextual menu allowing to navigate easily through the electrical values. Alternatively a Quickview option allows to display the main basic values.

Optional external 24 Vdc supply module is required to process and display the measurements including energy counters for currents below 20 % of the rated current.

The phase to neutral voltages are available for 4 poles circuit breakers and 3 poles circuit breakers as well providing the connection of the MicroLogic 5/6 E to the neutral (ENVT). This connection is mandatory for an accurate active power measurement.

Neutral-Phase measurement is only possible on the 4-pole MicroLogic Vigi 7 E (not on the 3-pole).

No External Neutral connection on the MicroLogic Vigi 7 E.

Please refer to the user manual for more details concerning the wiring and the configuration of MicroLogic 5/6/7 E.

ComPacT NSX Measurement MicroLogic 5/6/7 E Electronic Trip Units

B

MicroLogic 5/6/7 E for Energy Management Functions

Active Power and Energy metering in ComPacT NSX with MicroLogic 5/6/7 E has been designed and tested to provide accuracy: **Class 2 according to IEC/EN 61557-12**. This standard specifies requirements for combined performance of measuring and monitoring devices that measure and monitor the electrical parameters within electrical distribution systems. It covers both devices with external sensors such as current and/or voltage transformers like stand alone power meter (PMD-S) and devices with embedded sensors (PMD-D) like circuit breakers.

In addition a list of available performance class for all relevant measurement functions is specified in IEC/EN 61557-12, in opposition to most other standards such as IEC 62053-2x series that are dealing only with active and reactive energy.

ComPacT NSX equipped with MicroLogic 5/6/7 E and its own embedded sensors is a Class 2 full chain measurement PMD-D device for active power and energy metering according to IEC/EN 61557-12.

PMD-D offer the benefit of avoiding uncertainty and variation due to external sensors and wiring.

IEC/EN 61557-12 standard defines three levels of uncertainty (intrinsic uncertainty, operating uncertainty, overall system uncertainty) that need to be checked to ensure accuracy class.

The uncertainty is the estimated amount or percentage by which a measured value may differ from the true value. According to IEC/EN 61557-12, the total uncertainty of a measurement, in general, depends on the instrument, the environment, and other elements to be considered.

Note: Requirements for Class 2 active power and energy in IEC/EN 61557-12 regarding limits of uncertainty due to variation of the current for different power factor, and limits of uncertainty due to influence quantities such as temperature are equivalent to IEC 62053-2x standards.

PMD-D - Embedded Sensors

Intrinsic uncertainty Uncertainty under reference conditions	Operating uncertainty + measurement uncertainty according to IEC 61000-4-30 Variations due to influence quantities	Overall system uncertainty: No additional error for PMD-D 0
---	--	---

PMD-S - External Sensors

Intrinsic uncertainty Uncertainty under reference conditions	Operating uncertainty + measurement uncertainty according to IEC 61000-4-30 Variations due to influence quantities	Overall system uncertainty Uncertainty and variations due to external sensors accuracy and to resistance of wires
---	--	--



PMD-D - Embedded sensors

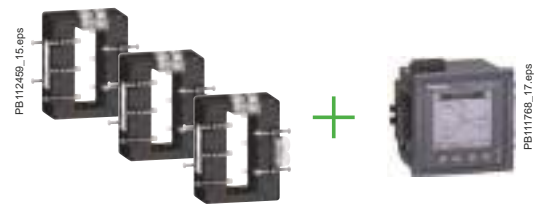

PMD-S - External sensors

ComPacT NSX Measurement

MicroLogic 5/6/7 E Electronic Trip Units

B

Compliance with ISO 50001: Reliability and Repeatability Over Time of Energy Measurement

Scope and main requirements of ISO 50001:

ISO 50001 specifies requirements for systems and organization dedicated to energy management. This international standard defines rules and gives recommendations to achieve continual improvement of energy performance, including energy efficiency, energy use and consumption, measurements, documentation and reporting. Energy performance shall be monitored and significant deviations shall be investigated. It implies that the accuracy of the instruments used for this purpose remains stable throughout their entire operating life which ensures the repeatability of the measurements (ISO 50001, clause 4.6 and 4.6.1 Checking, monitoring, measurement and analysis).

In ComPacT NSX with MicroLogic 5/6/7 E, the metering and protection functions are designed to perform accurate and repeatable measurements during MicroLogic E life time, provided it's used in the specified environmental conditions as defined in ComPacT NSX User Guide. Current sensors and MicroLogic E are calibrated during circuit breaker manufacturing and are not supposed to be re-calibrated during this life time. In general, electronic instrument measuring electric parameters don't request any specific maintenance provided they are working within environmental specifications. Accuracy can be reduced in case of operation under exceptional conditions, lightning strikes, high temperature, high degree of humidity, this is why a periodic verification is recommended (please refer to the annex I of the AFNOR Document FD X30-147: Metrological maintenance recommendations, applicable to electrical and fluidic measurements).

IEC 60364-8-1 Clause 8.3.1.1 Requirement on Accuracy and Measuring Range

Scope and main requirements of IEC 60364-8-1:

IEC 60364-8-1 provides requirements and recommendations for the design, erection and verification of low voltage electrical installations including local production and storage of energy for optimizing the overall efficient use of electricity. It introduces recommendations for the design of an electrical installation within the framework of an energy efficiency management approach in order to get low electrical energy consumption and acceptable energy availability. It also specifies the accuracies of the measuring instruments involved in the functions of energy management such as:

- Energy usage analysis and optimization
- Contract optimization
- Cost allocation
- Efficiency assessment
- Energy usage trends assessment.

ComPacT NSX with MicroLogic 5/6/7 E complies with the requirements of IEC 60364-8-1 dedicated to the optimization of energy efficiency. It provides a range of measurements with accuracies required for complex energy efficiency approaches.

The table below from IEC 60364-8-1:2014 Clause 8.3.1.1 "Requirement on accuracy and measuring range" specifies the accuracies required for the measurements dedicated to cost management

	Incomer	ComPacT NSX main applications		Final distribution board
		Main LV switchboard	Intermediate distribution boards	
Measurement objectives for cost management	<ul style="list-style-type: none"> ■ Revenue metering ■ Bill checking ■ Energy usage analysis and optimization ■ Contract optimization ■ Regulatory compliance 	<ul style="list-style-type: none"> ■ Cost allocation ■ Energy usage analysis and optimization ■ Efficiency assessment ■ Contract optimization ■ Regulatory compliance 	<ul style="list-style-type: none"> ■ Cost allocation ■ Energy usage analysis and optimization ■ Efficiency assessment ■ Contract optimization ■ Regulatory compliance 	<ul style="list-style-type: none"> ■ Energy usage analysis and optimization ■ Energy usage trends assessment
Overall system accuracy of active energy measurement	In general, excellent accuracy, e.g. class 0.2 to class 1	In general, good accuracy, e.g. class 0.5 to class 2	In general, medium accuracy, e.g. class 1 to class 3	In general, reliable indication should be more important than accuracy

ComPacT NSX Measurement MicroLogic 5/6/7 E Electronic Trip Units

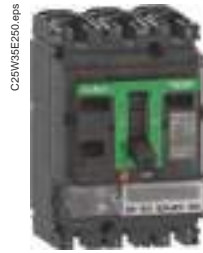

MicroLogic 5/6/7 Integrated Power Meter Functions			Type	Display	
			E	MicroLogic LCD	FDM display
Display of protection settings					
Pick-ups (A) and delays	Settings MicroLogic 5/6	I _r , tr, I _{sd} , t _{sd} , I _i , I _g , t _g	●	●	-
	Settings MicroLogic Vigi 7 E [4]	I _r , tr, I _{sd} , t _{sd} , I _i , I _{Δn} , Δt, I _{Δn} % pre-alarm	●	●	
Measurements					
Instantaneous rms measurements					
Currents (A)	Phases and neutral	I ₁ , I ₂ , I ₃ , I _N	●	●	●
	Average of phases	I _{avg} = (I ₁ + I ₂ + I ₃)/3	●	-	●
	Highest current of the 3 phases and neutral	I _{max} of I ₁ , I ₂ , I ₃ , I _N	●	●	●
	Ground fault (MicroLogic 6)	% I _g (pick-up setting)	●	●	●
	Earth leakage (MicroLogic Vigi 7 E)	% I _{Δn} (pick-up setting)	●		
	Highest Earth Leakage current	I _{Δn} max	●	-	-
	Current unbalance between phases	% I _{avg}	●	-	●
Voltages (V)	Phase-to-phase	U ₁₂ , U ₂₃ , U ₃₁	●	●	●
	Phase-to-neutral	V _{1N} , V _{2N} , V _{3N}	●	●	●
	Average of phase-to-phase voltages	U _{avg} = (U ₁₂ + U ₂₁ + U ₂₃)/3	●	-	●
	Average of phase-to-neutral voltages	V _{avg} = (V _{1N} + V _{2N} + V _{3N})/3	●	-	●
	Ph-Ph and Ph-N voltage unbalance	% U _{avg} and % V _{avg}	●	-	●
	Phase sequence	1-2-3, 1-3-2	●	●	● [3]
Frequency (Hz)	Power system	f	●	-	●
Power	Active (kW)	P, total/per phase	●/●	●/-	●/●
	Reactive (kVAR)	Q, total/per phase	●/●	●/-	●/●
	Apparent (kVA)	S, total/per phase	●/●	●/-	●/●
	Power factor and cos φ (fundamental)	PF and cos φ, total and per phase	●	-	●
Maximeters/minimeters					
	Associated with instantaneous rms measurements	Reset via MicroLogic or FDM display unit	●	-	●
Energy metering					
Energy	Active (kWh), reactive (kvarh), apparent (kVAh)	Total since last reset Absolute or signed mode [1]	●	●	●
Demand and maximum demand values					
Demand current (A)	Phases and neutral	Present value on the selected window	●	-	●
		Maximum demand since last reset	●	-	●
Demand power	Active (kWh), reactive (kvarh), apparent (kVA)	Present value on the selected window	●	-	●
		Maximum demand since last reset	●	-	●
Calculation window	Sliding, fixed or com-synchronized	Adjustable from 5 to 60 minutes in 1 minute steps [2]	●	-	-
Power quality					
Total harmonic distortion (%)	Of voltage with respect to rms value	THDU, THDV of the Ph-Ph and Ph-N voltage	●	-	●
	Of current with respect to rms value	THDI of the phase current	●	-	●

[1] Absolute mode: E absolute = E out + E in; Signed mode: E signed = E out - E in.

[2] Available via the communication system only.

[3] FDM121 only.

[4] Two last I_{Δn} and Δt values are available as well as date of setting.

Additional technical characteristics

- Measurement accuracy
 Accuracies are those of the entire measurement system, including the sensors:
- Current: Class 1 as per IEC 61557-12
 - Voltage: 0.5 %
 - Power and energy: Class 2 as per IEC 61557-12
 - Frequency: 0.1 %.



ComPacT NSX Diagnostics & Maintenance

MicroLogic 5/6/7 E Electronic Trip Units

B

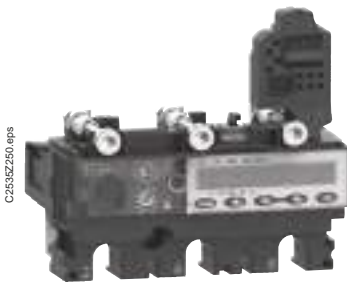

MicroLogic built-in LCD display

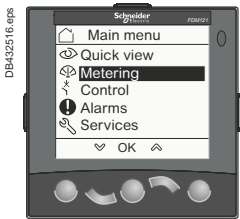

FDM121 display: navigation

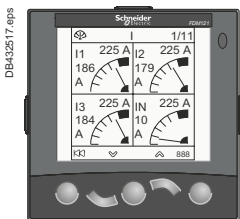

FDM121 display: current

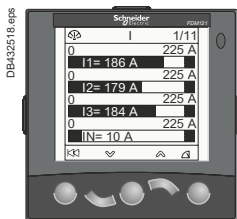

FDM121 display: voltage

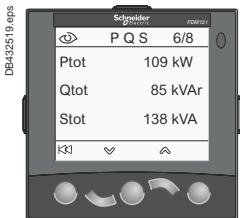

FDM121 display: power

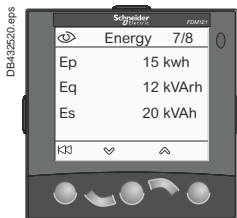

FDM121 display: consumption

Examples of operating-assistance screens on the FDM121 display unit

Personalized Alarms with Time-Stamping

Alarm types

The user can assign an alarm to all MicroLogic E measurements or events:

- Up to 12 alarms can be used together:
 - Two alarms are predefined and activated automatically:
 - MicroLogic 5: overload (Ir)
 - MicroLogic 6: overload (Ir) and ground fault (Ig)
 - MicroLogic Vigi 7 E: overload (Ir) and earth leakage fault (IΔn)
 - Thresholds, priorities and time delays can be set for ten other alarms.
- The same measurement can be used for different alarms to precisely monitor certain values, e.g. the frequency or the voltage
- Alarms can also be assigned to various states: phase lead/lag, four quadrants, phase sequence
- Selection of display priorities, with pop-up possibility
- Alarm time-stamping.

Alarm settings

Alarms cannot be set via the keypad or the FDM display unit. They are set via communication with the PC. Set-up includes the threshold, priority, activation delay before display and deactivation delay. It is also possible to reprogram the standard assignment for the two SDx relay outputs to user-selected alarms.

Alarm reading

Remote alarm indications.

- Reading on FDM display unit or on PC via the communication system.
- Remote indications via SDx relay with two output contacts for alarms.

Histories and Event Tables

MicroLogic E has histories and event tables that are always active.

Three types of time-stamped histories

- Tripping due to overruns of Ir, I_{sd}, I_i, I_g, IΔn: last 17 trips
- Alarms: last 10 alarms
- Operating events: last 10 events

Each history record is stored with:

- Indications in clear text in a number of user-selectable languages
- Time-stamping: date and time of event
- Status: pick-up/drop-out

Two types of time-stamped event tables

- Protection settings
- Minimizers/maximeters

Display of alarms and tables

The time-stamped histories and event tables may be displayed on a PC via the communication system.

Embedded memory

MicroLogic E has a non-volatile memory that registers all data on alarms, histories, event tables, counters and maintenance indicators even if power is lost.

Maintenance Indicators

MicroLogic E has indicators for, among others, the number of operating cycles, contact wear and operating times (operating hours counter) of the ComPacT NSX circuit breaker.

It is possible to assign an alarm to the operating cycle counter to plan maintenance. The various indicators can be used together with the trip histories to analyse the level of stresses the device has been subjected to.

The information provided by the indicators cannot be displayed on the MicroLogic LCD. It is displayed on the PC via the communication system.

Management of Installed Devices

Each circuit breaker equipped with a MicroLogic 5 or 6 or 7 trip unit can be identified via the communication system:

- Serial number
- Firmware version
- Hardware version
- Device name assigned by the user.

This information together with the previously described indications provides a clear view of the installed devices.

ComPacT NSX Diagnostics & Maintenance

MicroLogic 5/6/7 E Electronic Trip Units



MicroLogic 5/6/7 Operating Assistance Functions			Type	Display	
			E	MicroLogic LCD	FDM display
Operating assistance					
Personalized alarms					
Settings	Up to 10 alarms assigned to all A and E measurements ^[2]		⊙	-	-
	Phase lead/lag, four quadrants, phase sequence, display priority selection ^[2]		⊙	-	-
Display	Alarms/tripping/test (Earth Leakage)		⊙	⊙/⊙	⊙/⊙
Remote indications	Activation of two dedicated contacts on SDx module		⊙	-	-
Time-stamped histories (ms)					
Trips (last 17)	Cause of tripping	I _r , I _s d, I _i (MicroLogic 5, 6)	⊙	-	⊙
		I _g (MicroLogic 6)	⊙	-	⊙
		I _r , I _s d, I _i , I _Δ n (MicroLogic Vigi 7 E)	⊙	-	⊙
		Phase fault	⊙	-	⊙
		Interrupted current value	⊙	-	⊙
Alarms (last 10)			⊙	-	⊙
Test Earth Leakage (last 10)	MicroLogic Vigi 7 E		⊙	-	⊙
Operating events (last 10)	Event types	Modification of protection setting by dial	⊙	-	⊙
		Opening of keypad lock	⊙	-	⊙
		Test via keypad	⊙	-	⊙
		Test via external tool	⊙	-	⊙
		Time setting (date and time)	⊙	-	⊙
		Reset for maximeter/minimeter and energy meter	⊙	-	⊙
Time stamping (date and time, text, status)			⊙	-	⊙
Time-stamped event tables					
Protection settings	Setting modified (value displayed)	I _r , tr, I _s d, t _s d, I _i , I _g , t _g ^[2]	⊙	-	-
		I _r , tr, I _s d, t _s d, I _i , I _Δ n, Δt (MicroLogic Vigi 7 E) ^[2]	⊙	-	⊙
		Time-stamping	⊙	-	-
		Previous value	⊙	-	-
Min/Max	Values monitored	I ₁ , I ₂ , I ₃ , I _N	⊙	-	⊙
		U ₁₂ , U ₂₃ , U ₃₁ , f	⊙	-	⊙
	Time-stamping of each value	⊙	-	⊙	
	Current min/max value	⊙	-	⊙	
Maintenance indicators					
Counter		Mechanical cycles ^[1]	⊙	-	⊙
		Electrical cycles ^[1]	⊙	-	⊙
		Trips	⊙	-	-
		Alarms	⊙	-	-
		Hours	⊙	-	-
Indicator	Contact wear	%	⊙	-	⊙
Load profile	Hours at different load levels	% of hours in four current ranges: 0-49 % I _n , 50-79 % I _n , 80-89 % I _n and ≥ 90 % I _n	⊙	-	⊙

[1] The BSCM module is required for these functions.
 [2] Available via the communication system only.

Additional technical characteristics

Contact wear

Each time ComPacT NSX opens, the MicroLogic 5/6/7 trip unit measures the interrupted current and increments the contact-wear indicator as a function of the interrupted current, according to test results stored in memory. Breaking under normal load conditions results in a very slight increment. The indicator value may be read on the FDM121 display. It provides an estimation of contact wear calculated on the basis of the cumulative forces affecting the circuit breaker. When the indicator reaches 80 %, it is advised to replace the circuit breaker to ensure the availability of the protected equipment.

Circuit breaker load profile

MicroLogic 5/6/7 calculates the load profile of the circuit breaker protecting a load circuit. The profile indicates the percentage of the total operating time at four current levels (% of breaker I_n):

- 0 to 49 % I_n
- 50 to 79 % I_n
- 80 to 89 % I_n
- ≥ 90 % I_n. This information can be used to optimize use of the protected equipment or to plan ahead for extensions.



ComPacT NSX Diagnostics & Maintenance

MicroLogic 5/6/7 E Electronic Trip Units

Electrical power supply availability and reliability are the main critical issues affecting profitability and competitiveness. Outage management focuses on preventing, detecting, locating and clearing faults.

B

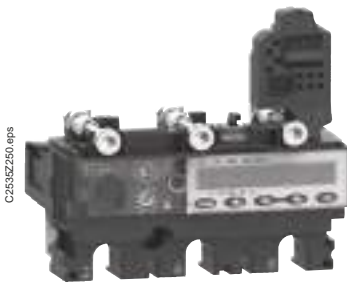

MicroLogic built-in LCD display

The MicroLogic 5/6/7 E control units perform in real time a high level of diagnostics on ComPacT NSX circuit breakers. They generate and store appropriate warnings, alarms and messages to help the users with maintenance and power restoration. This function complies with the following end user values:

- Prevent interruption of the power supply, to ensure continuity of operation, to preserve the asset from any damage and to support people safety.
- Reduce downtime resulting from an unexpected failure in the electrical distribution system, to be able to restart as quickly as possible after a trip.
- To keep the devices in good condition of operation.

Prevention of Power Supply Interruptions

Prevention of power supply interruptions is achieved by generation of warnings to the users, preventive operations of maintenance, and anticipation of device replacement.

By means of dedicated features, MicroLogic 5/6/7 E monitors the health of the circuit breaker and generates appropriate information to help the users in scheduling periodic checks and, if needed, anticipated replacement of devices.

ComPacT NSX Special Applications

Protection of Public Distribution Systems with MicroLogic 2-AB

MicroLogic AB trip units are used in public distribution systems to limit the current supplied according to the consumer's contract. They are available in 100, 160, 240 and 400 A ratings and are supplied with a lead-seal device to protect the settings.

ComPacT NSX circuit breakers equipped with MicroLogic AB trip units are installed as incoming devices for consumer installations connected to the public LV distribution system.

With respect to the utility, they have two functions.

- Consumption is limited to the contractual power level. If the limit is exceeded, a fast thermal-protection function trips the device at the head of the consumer's installation without the utility having to intervene.
- Total selectivity is ensured with the upstream fuses on the public distribution system in the event of a fault, overload or short-circuit in the consumer's installation, protecting the utility line.

In addition, they provide the consumer with:

- Protection for the installation as a whole, with the possibility of adding a Vigi earth-leakage protection module
- The possibility of downstream selectivity.

This type of ComPacT NSX is often used in conjunction with an ComPacT INV switch-disconnector located outside the consumer's building and providing the visible-break function.

This means the operator can directly see, through a transparent cover, the physical separation of the main contacts. The ComPacT INV range is also suitable for isolation with positive contact indication.

This means utility operators can work on the service-connection unit after isolating it from the upstream line.



ComPacT NSX with MicroLogic 2 AB

DB436766.ai

C251V44D250.eps

B

ComPacT NSX Special Applications

Protection of Public Distribution Systems with MicroLogic 2-AB



Protection

Settings are made using the adjustment dials with fine-adjustment possibilities and a lead-seal fixture.

Overloads: Long-time protection (I_r)

Inverse-time thermal protection against overloads with an adjustable current pick-up I_r and a very short, non-adjustable time delay t_r (15 seconds for $1.5 \times I_r$).

Short-circuits: Short-time protection (I_{sd}) with fixed time delay

Short-circuit protection with an adjustable pick-up I_{sd} . The short-time pick-up values are high enough to avoid nuisance tripping in the event of transient current spikes.

Short-circuits: Non-adjustable instantaneous protection

Instantaneous short-circuit protection with a fixed pick-up.

Neutral protection

Available on four-pole circuit breakers only. Neutral protection may be set using a three-position switch:

- 4P 3D: neutral unprotected
- 4P 3D + N/2: neutral protection at half the value of the phase pick-up, i.e. $0.5 \times I_r$
- 4P 4D: neutral fully protected at I_r .

Indications

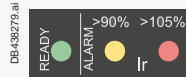

Front indications

- Green "Ready" LED: flashes slowly when the circuit breaker is ready to trip in the event of a fault.
- Orange overload pre-alarm LED: steady on when $I > 90\% I_r$.
- Red overload LED: steady on when $I > 105\% I_r$.

Remote indications

An SDx relay module installed inside the circuit breaker can be used to remote the overload-trip signal. This module receives the signal from the MicroLogic electronic trip unit via an optical link and makes it available on the terminal block. The signal is cleared when the circuit breaker is closed.

The module is described in detail in the section dealing with accessories [page C-31](#).



SDx remote indication relay module with its terminal block

B

ComPacT NSX Special Applications

Protection of Public Distribution Systems with MicroLogic 2-AB

B

MicroLogic 2.2/2.3 AB

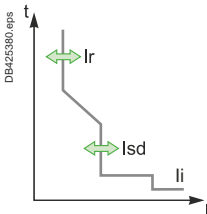

Ratings (A)	In at 40 °C ⁽¹⁾	100	160	240	400
Circuit breaker	ComPacT NSX100	●	-	-	-
	ComPacT NSX160	●	●	-	-
	ComPacT NSX250	●	●	●	-
	ComPacT NSX400	-	-	-	●
	ComPacT NSX630	-	-	-	●

L Long-time protection

Pick-up (A) tripping between 1.05 and 1.20 Ir	Ir	Value depending on trip unit rating (In) and setting on dial								
	In = 100 A	Ir =	40	40	50	60	70	80	90	100
	In = 160 A	Ir =	90	100	110	120	130	140	150	160
	In = 240 A	Ir =	140	150	160	170	180	200	220	240
	In = 400 A	Ir =	260	280	300	320	340	360	380	400
Time delay (s)	tr	Non-adjustable								
	1.5 Ir	15								
	6 Ir	0.5								
	7.2 Ir	0.35								

Thermal memory 20 minutes before and after tripping

S_n Short-time protection with fixed time delay

Pick-up (A) accuracy ±10 %	Isd = Ir x ...	1.5	2	3	4	5	6	7	8	10
Time delay (ms)	tsd	Non-adjustable: 20								
	Non-tripping time	20								
	Maximum break time	80								

I Non-adjustable instantaneous protection

Pick-up (A) accuracy ±15 %	Ii non-adjustable	1500	1600	2880	4800
Time delay (ms)	Non-tripping time	10			
	Maximum break time	50			

[1] If the trip units are used in high-temperature environments, the MicroLogic setting must take into account the thermal limitations of the circuit breaker. See the temperature derating table.

Technical details

Advantages of the AB trip unit

- Controls the power drawn with respect to contractual power levels. If the contractual level is overrun, the circuit breaker opens and the consumer is not billed excess costs.
- If a short-circuit occurs, the circuit breaker opens and the upstream HRC fuses on utility lines are not affected. No expensive utility servicing is billed to the consumer.

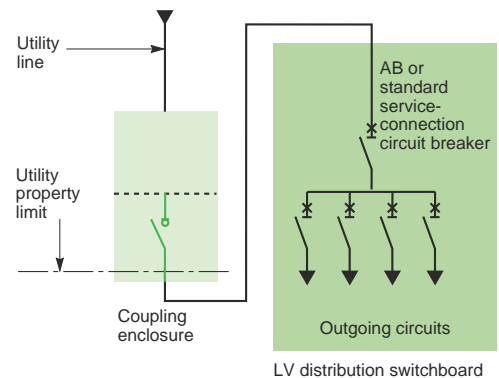

Consumer connection diagram

ComPacT NSX Special Applications

ComPacT NSX MicroLogic Vigi 4-AB Trip Unit with Embedded Earth Leakage Protection

The ComPacT NSX range for public distribution is now complemented with a new type of MicroLogic AB trip unit including both circuit protection and earth leakage protection. It means that the earth leakage protection, previously located within the VigiPacT add-on, will be embedded within the existing size of the MicroLogic AB trip unit.

B

C25448250.eps



MicroLogic Vigi 4.2-AB trip unit

MicroLogic Vigi 4-AB

ComPacT ELCB ⁽¹⁾ equipped with that "new" earth leakage trip unit MicroLogic AB are installed as an incoming device for installation connected with the public LV distribution system. With respect to the utility requirement, it ensures the same functions as the standard circuit breaker: limitation of consumption, selectivity upstream and downstream, combination with ComPacT INV to ensure the visible break or positive contact indication.

Short Circuit and Overload Protections

Settings are made using the rotary dial with fine adjustment capabilities and lead-seal fixture.

Overload: Long-Time Protection (I_r)

Inverse time protection against overload with an adjustable current pick-up I_r set using a dial and a very short non-adjustable time delay t_r (15 seconds at 1.5 I_r).

Short-Circuit: Short-Time Protection with Fixed Time Delay (I_{sd})

That protection is set with an adjustable pick-up I_{sd} . The short time pick-up values are high enough to avoid nuisance tripping in the event of transient current spikes.

Short Circuit: Non-Adjustable Instantaneous Protection (with a Fix Pick-up)

Neutral Protection

Available on four-pole ComPacT NSX MicroLogic Vigi 4-AB only, the neutral protection may be set using the dedicated coding wheel to meet the following configurations: 4P 3D, 4P 3D + N/2 or 4P 4D. (same as for the MicroLogic 2-AB)

Earth Leakage Protections

Adjustable leakage threshold ($I_{\Delta n}$) and adjustable time threshold (Δt) by using the two dials on the green area of the trip unit.

The ComPacT NSX MicroLogic Vigi 4-AB, embedding a MicroLogic AB can only be "Trip" type, the "Alarm" version (as for MicroLogic Vigi 4 and 7 E) doesn't exist.

Power Supply

The trip unit is self supplied, and so does not need any external source. It works even when fed by 2 phases only!

Sensitivity $I_{\Delta n}$ (A)

- Type A: 30mA - 100mA - 300mA - 500mA - 1A - 3A - 5A (for the ratings 100 to 240A)
- Type A: 300mA - 500mA - 1A - 3A - 5A - 10A (for the rating 400A)

Caution: "OFF" setting of $I_{\Delta n}$ is possible, it cancels the earth leakage protection, in that case, the ComPacT NSX MicroLogic Vigi 4-AB behaves as a standard circuit breaker. "OFF" position is located on the highest side of the coding wheel.

Intentional Delay Δt (S)

Case $I_{\Delta n} = 30\text{mA}$: 0 sec (whatever the setting)

Case $I_{\Delta n} > 30\text{mA}$: 0 - 60ms - 150ms - 500ms - 1sec (by setting)

Operated Voltage

200 to 440 VAC (only) - 50/60 Hz

Operating Safety

The earth leakage protection is a user safety device. It must be regularly tested using the test button (T) that simulates a real current leakage within the toroid.

When $I_{\Delta n}$ is set on the OFF position, press the T will cancel any test.

As for standard circuit breaker, the circuit breaker with MicroLogic Vigi 4-AB can be reset after any fault by operating an OFF/ON procedure.

ComPacT NSX Special Applications

ComPacT NSX MicroLogic Vigi 4-AB Trip Unit with Embedded Earth Leakage Protection

Indications

Front Indications

- Green "Ready" LED: flashes slowly when the circuit breaker is ready to trip in case of a fault.
- Orange overload pre-alarm LED: steady ON when $I > 90\% I_r$.
- Red overload LED: steady ON when $I > 105\% I_r$.
- Yellow Screen: indicates an earth leakage fault (reset when the device is operated OFF/ON).

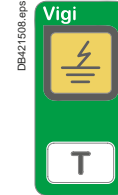
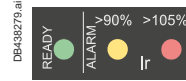

Alarming and Fault Differentiation

- An overload trip signal can be remotely available by installing an SDx relay module inside the circuit breaker.
 - An earth leakage pre-alarm can be remotely available by installing an SDx module, only on the ComPacT NSX MicroLogic Vigi 4-AB.
- This module receives the signal from the MicroLogic electronic trip unit via an optical link and makes it available on the terminal block. The signal is reset when the breaker is operated.



MicroLogic Vigi 4-AB (Earth Leakage "Trip" Version Only)

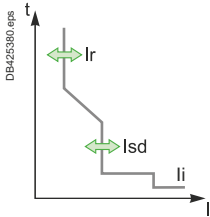

Ratings (A)	In at 40 °C [1]	100	160	240	400
Circuit breaker	ComPacT NSX100	●			
	ComPacT NSX160	●	●		
	ComPacT NSX250	●	●	●	
	ComPacT NSX400				●
	ComPacT NSX630				●

L Long-time protection											
Pick-up (A)	Ir	Value depending on the rating (In) and the dial setting (9 positions)									
tripping between 1.05 and 1.20 Ir	In = 100 A	Io =	40	40	40	50	60	70	80	90	100
	In = 160 A	Io =	90	90	100	110	120	130	140	150	160
	In = 240 A	Io =	140	140	150	160	170	180	200	220	240
	In = 400 A	Io =	260	260	280	300	320	340	360	380	400

Time delay (s)	tr	Non-adjustable										
accuracy 0 to -20%	at	1.5 x Ir	tr = 15 s									
	at	6 x Ir	tr = 0.5 s									
	at	7.2 x Ir	tr = 0.35 s									

Thermal memory	20 minutes before and after tripping									
----------------	--------------------------------------	--	--	--	--	--	--	--	--	--

S ₀ Short-time protection with fixed time delay											
Pick-up (A)	Isd = Ir x ...	1.5	2	3	4	5	6	7	8	10	
accuracy ±10 %											
Time delay (ms)	tsd	Non-adjustable									
	Non-tripping time	20									
	Maximum break time	80									

I Instantaneous protection											
Pick-up (A)	li non-adjustable	1500	1600	2880	4800						
	accuracy ±15 %										
	Non-tripping time	10 ms									
	Maximum break time	50 ms									

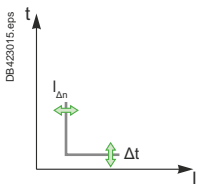

R Earth leakage protection											
Sensitivity (A)	Type A, adjustable (9 positions)										
	In = 100 A	IΔn =	0.03	0.03	0.1	0.3	0.5	1	3	5	OFF
	In = 160 A	IΔn =	0.03	0.03	0.1	0.3	0.5	1	3	5	OFF
	In = 240 A	IΔn =	0.03	0.03	0.1	0.3	0.5	1	3	5	OFF
	In = 400 A	IΔn =	0.3	0.3	0.5	1	3	5	10	10	OFF
Time delay Δt (ms)	Adjustable	Δt =	0	60 [2]	150 [2]	500 [2]	1000 [2]				
	Maximum break time (ms)		<40	<140	<300	<800	<1500				

[1] For the use in high temperature environment, take into account the thermal limitation of the breaker.
 [2] The time delay (Δt) is mandatory and designed "Δt = 0" when the IΔn dial is set on 30mA (0.03). The time delay has no effect when the dial IΔn is set to the "OFF" position.

Select Protection

ComPacT NSX Special Applications

Generator Protection with MicroLogic 2.2 G

MicroLogic G trip units are used for the protection of systems supplied by generators or comprising long cable lengths. They can be mounted on all ComPacT NSX100/160/250 circuit breakers.

With extensive setting possibilities, MicroLogic 5 offers the same functions from 100 to 630 A.

A thermal-magnetic trip unit is also available for the NSX100 to 250 (see page B-6).

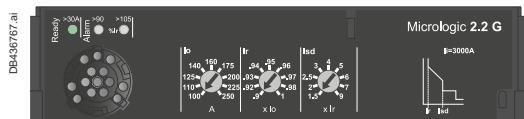

Circuit breakers equipped with MicroLogic G trip units help protect systems supplied by generators (lower short-circuit currents than with transformers) and distribution systems with long cable lengths (fault currents limited by the resistance of the cable).

Protection

Settings are made using the adjustment dials with fine adjustment possibilities.

Overloads: Long-time protection (Ir)

Inverse-time thermal protection against overloads with an adjustable current pick-up Ir and a very short, non-adjustable time delay tr (15 seconds for 1.5 x Ir).

Short-circuits: Short-time protection (Isd) with fixed time delay

Short-circuit protection with an adjustable pick-up Isd, delayed 200 ms, in compliance with the requirements of marine classification companies.

Short-circuits: Non-adjustable instantaneous protection (Ii)

Instantaneous short-circuit protection with a fixed pick-up required for generator protection.

Neutral protection

- On 3-pole circuit breakers, neutral protection is not possible.
- On four-pole circuit breakers, neutral protection may be set using a three-position switch:
 - 4P 3D: neutral unprotected
 - 4P 3D + N/2: neutral protection at half the value of the phase pick-up, i.e. 0.5 x Ir
 - 4P 4D: neutral fully protected at Ir.

Indications

Front indications



- Green "Ready" LED: flashes slowly when the circuit breaker is ready to trip in the event of a fault.
- Orange overload pre-alarm LED: steady on when $I > 90\% I_r$.
- Red overload LED: steady on when $I > 105\% I_r$.

Remote indications

An SDx relay module installed inside the circuit breaker can be used to remote the overload-trip signal.

This module receives the signal from the MicroLogic electronic trip unit via an optical link and makes it available on the terminal block. The signal is cleared when the circuit breaker is closed.

The module is described in detail in the section dealing with accessories.



SDx remote indication relay module with its terminal block

ComPacT NSX Special Applications Generator Protection with MicroLogic 2.2 G

MicroLogic 2.2 G

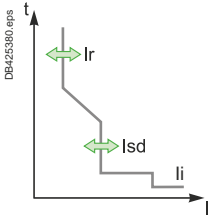

Ratings (A)	In at 40 °C [1]	40	100	160	250
Circuit breaker	ComPacT NSX100	<input checked="" type="radio"/>	<input checked="" type="radio"/>	-	-
	ComPacT NSX160	<input checked="" type="radio"/>	<input checked="" type="radio"/>	<input checked="" type="radio"/>	-
	ComPacT NSX250	<input checked="" type="radio"/>	<input checked="" type="radio"/>	<input checked="" type="radio"/>	<input checked="" type="radio"/>

L Long-time protection																																																								
Pick-up (A) tripping between 1.05 and 1.20 Ir	<table border="1"> <thead> <tr> <th>Io</th> <th colspan="10">Value depending on trip unit rating (In) and setting on dial</th> </tr> </thead> <tbody> <tr> <td>In = 40 A</td> <td>Io =</td> <td>18</td> <td>18</td> <td>20</td> <td>23</td> <td>25</td> <td>28</td> <td>32</td> <td>36</td> <td>40</td> </tr> <tr> <td>In = 100 A</td> <td>Io =</td> <td>40</td> <td>45</td> <td>50</td> <td>55</td> <td>63</td> <td>70</td> <td>80</td> <td>90</td> <td>100</td> </tr> <tr> <td>In = 160 A</td> <td>Io =</td> <td>63</td> <td>70</td> <td>80</td> <td>90</td> <td>100</td> <td>110</td> <td>125</td> <td>150</td> <td>160</td> </tr> <tr> <td>In = 250 A (NSX250)</td> <td>Io =</td> <td>100</td> <td>110</td> <td>125</td> <td>140</td> <td>150</td> <td>176</td> <td>200</td> <td>225</td> <td>250</td> </tr> </tbody> </table>	Io	Value depending on trip unit rating (In) and setting on dial										In = 40 A	Io =	18	18	20	23	25	28	32	36	40	In = 100 A	Io =	40	45	50	55	63	70	80	90	100	In = 160 A	Io =	63	70	80	90	100	110	125	150	160	In = 250 A (NSX250)	Io =	100	110	125	140	150	176	200	225	250
Io	Value depending on trip unit rating (In) and setting on dial																																																							
In = 40 A	Io =	18	18	20	23	25	28	32	36	40																																														
In = 100 A	Io =	40	45	50	55	63	70	80	90	100																																														
In = 160 A	Io =	63	70	80	90	100	110	125	150	160																																														
In = 250 A (NSX250)	Io =	100	110	125	140	150	176	200	225	250																																														
	Ir = Io x ... 9 fine-adjustment settings from 0.9 to 1 for each Io value																																																							
Time delay (s) accuracy 0 to -20 %	<table border="1"> <thead> <tr> <th>tr</th> <th>Non-adjustable</th> </tr> </thead> <tbody> <tr> <td>1.5 x Ir</td> <td>15</td> </tr> <tr> <td>6 x Ir</td> <td>0.5</td> </tr> <tr> <td>7.2 x Ir</td> <td>0.35</td> </tr> </tbody> </table>	tr	Non-adjustable	1.5 x Ir	15	6 x Ir	0.5	7.2 x Ir	0.35																																															
tr	Non-adjustable																																																							
1.5 x Ir	15																																																							
6 x Ir	0.5																																																							
7.2 x Ir	0.35																																																							
Thermal memory	20 minutes before and after tripping																																																							

S0 Short-time protection with fixed time delay																							
Pick-up (A) accuracy ±10 %	<table border="1"> <thead> <tr> <th>I_{sd} = Ir x ...</th> <th>1.5</th> <th>2</th> <th>2.5</th> <th>3</th> <th>4</th> <th>5</th> <th>6</th> <th>7</th> <th>8</th> <th>9</th> </tr> </thead> <tbody> <tr> <td>I_{sd}</td> <td>1.5</td> <td>2</td> <td>2.5</td> <td>3</td> <td>4</td> <td>5</td> <td>6</td> <td>7</td> <td>8</td> <td>9</td> </tr> </tbody> </table>	I _{sd} = Ir x ...	1.5	2	2.5	3	4	5	6	7	8	9	I _{sd}	1.5	2	2.5	3	4	5	6	7	8	9
I _{sd} = Ir x ...	1.5	2	2.5	3	4	5	6	7	8	9													
I _{sd}	1.5	2	2.5	3	4	5	6	7	8	9													
Time delay (ms)	<table border="1"> <thead> <tr> <th>tsd</th> <th>Non-adjustable</th> </tr> </thead> <tbody> <tr> <td>Non-tripping time</td> <td>140</td> </tr> <tr> <td>Maximum break time</td> <td>200</td> </tr> </tbody> </table>	tsd	Non-adjustable	Non-tripping time	140	Maximum break time	200																
tsd	Non-adjustable																						
Non-tripping time	140																						
Maximum break time	200																						

I Non-adjustable instantaneous protection																					
Pick-up (A) accuracy ±15 %	<table border="1"> <thead> <tr> <th>Ii non-adjustable</th> <th>600</th> <th>1500</th> <th>2400</th> <th>3000</th> </tr> </thead> <tbody> <tr> <td>Ii</td> <td>600</td> <td>1500</td> <td>2400</td> <td>3000</td> </tr> <tr> <td>Non-tripping time</td> <td colspan="4">15 ms</td> </tr> <tr> <td>Maximum break time</td> <td colspan="4">50 ms</td> </tr> </tbody> </table>	Ii non-adjustable	600	1500	2400	3000	Ii	600	1500	2400	3000	Non-tripping time	15 ms				Maximum break time	50 ms			
Ii non-adjustable	600	1500	2400	3000																	
Ii	600	1500	2400	3000																	
Non-tripping time	15 ms																				
Maximum break time	50 ms																				

[1] If the trip units are used in high-temperature environments, the MicroLogic setting must take into account the thermal limitations of the circuit breaker. See the temperature derating table.



ComPacT NSX Special Applications

Protection of Industrial Control Panels

ComPacT NSX circuit breakers are also used in industrial control panels.

They serve as an incoming devices or can be combined with contactors to protect motor feeders:

- Compliance with worldwide standards including IEC 60947-2 and UL 60947-4/CSA 22-2 no. 14
- Overload and short-circuit protection
- Isolation with positive contact indication, making it possible to isolate machines from all power sources
- Installation in universal and functional type enclosures
- NA switch-disconnector version.

B

DB438641.ai

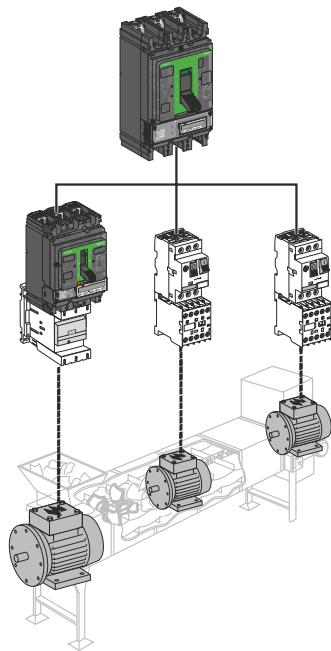

DB115234.eps



Industrial Control Panels

ComPacT NSX circuit breakers equipped for public distribution or motor protection functions as described in the previous pages can be used in industrial control panels. The accessories for the ComPacT NSX range are suitable for the special needs of these switchboards.

Auxiliaries

All auxiliaries can be added to the circuit breaker by the user:

- Padlocking devices (in the OFF position)
- Rotary handle
- Status-indication auxiliary contacts (ON, OFF and tripped)
- Shunt (MX) or undervoltage (MN) releases
- Early-make or early-break contacts.

Rotary handle

Direct or extended versions for mounting up to 600 mm behind the front:

- Black front with black handle
- Yellow front with red handle (for machine tools or emergency off as per IEC 204/VDE 0013).

All rotary handles can be padlocked in the OFF position. Optional door interlock, recommended for MCC panels (motor control centres).

When the device is equipped with an extended rotary handle, a control accessory mounted on the shaft makes it possible to operate the device with the door open. The device can be padlocked in the OFF position in compliance with UL508.

Early-make or early-break contacts

These contacts can be used respectively to supply an MN undervoltage release before the circuit breaker closes or to open the contactor control circuit before the circuit breaker opens.

Special functions

- Indication of thermal overloads with the SDx module.
- Early opening of the contactor for overload faults with the SDTAM module.
- Links with PLCs via the communication system.
- Measurement of all electrical parameters with MicroLogic E.
- Programmable alarms with MicroLogic 5 and 6.

Installation in Enclosures

ComPacT circuit breakers can be installed in a metal enclosure together with other devices (contactors, motor-protection circuit breakers, LEDs, etc.).

ComPacT NSX Special Applications

Protection of Industrial Control Panels



Compliance with North American Industrial Control Equipment Standards

ComPacT NSX devices have received UL508/CSA 22-2 no. 14 approval for industrial control equipment of the "Manual Motor Controller", "Across the Line Starter", "General Use" and "Disconnecting Means" types.

Type NA devices are switch-disconnectors that must always be protected upstream.

UL508 approval

Circuit breakers	Trip units	Approvals
ComPacT NSX100 to 630 F/N/H	TMD, MicroLogic 2, 5 and 6	General Use Motor Disconnecting Means
	NA, MA, MicroLogic 1.3 M, 2.2 M, 2.3 M, MicroLogic 6.2 E-M and 6.3 E-M	Manual Motor Controller Across the Line Starter Motor Disconnecting Means

Table of 3-phase motor ratings in hp (1 hp = 0.7457 kW)

V AC ratings		115	230	460	575
TMD MicroLogic 2, 5 and 6	NA, MA MicroLogic 1.3 M, 2.2 M, 2.3 M MicroLogic 6.2 E-M and 6.3 E-M				
25	25	3	7.5	15	20
50	50	7.5	15	30	40
100	100	15	30	75	100
160	150	25	50	100	150
250	220	40	75	150	200
400	320	-	125	250	300
550	500	-	150	350	500

The deratings indicated on pages E-14 to E-17 apply to TMD, MicroLogic 2, 5 and 6 trip units, rated at 40 °C

ComPacT NSX Special Applications

16 Hz 2/3 Network Protection - MicroLogic 5 A-Z Trip Unit

ComPacT NSX circuit breakers may be used on 16 Hz 2/3 systems with special thermal-magnetic and electronic (MicroLogic 5 A-Z) trip units.

B

16 Hz 2/3 Networks

Single-phase distribution networks with a frequency of 16 Hz 2/3 are used for railroad applications in certain European countries.

Breaking Capacity for 16 Hz 2/3 at 250/500 V

ComPacT NSX circuit breakers of the 3P 3D type protect 16 Hz 2/3 networks at 250 V or 500 V.

They can be equipped with either:

- A TM-D thermal-magnetic trip unit for ComPacT NSX100 to 250
- Or an electronic MicroLogic 5.2 A-Z trip unit for ComPacT NSX100 to 250 or a 5.3 A-Z for ComPacT NSX400/630.

The possible breaking-capacity performance levels are B, F, N and H as indicated below.

Breaking capacity I_{cu}

Operating voltage	Performance	TMD and MicroLogic 5 A-Z trip units			
		B	F	N	H
250 V/500 V	I _{cu} (kA)	25	36	50	70

Protection

TM-D Thermal-Magnetic Trip Units

The 16 Hz 2/3 frequency does not modify the thermal settings with respect to those at 50 Hz (see page B-6). The magnetic pick-ups are modified as shown below.

Magnetic protection for ComPacT NSX 100/160/250 at 50 Hz and at 16 Hz 2/3

Rating (A) I _n at 40 °C		16	25	32	40	50	63	80	100	125	160	200	250	
Pick-up (A) I _i accur. ±20%	Fixed												Adjustable	
NSX100	50Hz	190	300	400	500	500	500	640	800					
	16Hz 2/3	170	270	360	450	450	450	580	720					
NSX160/250	50Hz	190	300	400	500	500	500	640	800	1250	1250			
	16 Hz 2/3	170	270	360	450	450	450	580	720	1100	1100	4.5 to 9 I _n		

MicroLogic 5 A-Z Trip Units

MicroLogic 5.2 A-Z and 5.3 A-Z are dedicated to 16 Hz 2/3 networks.

They use a suitable sampling frequency. The protection settings are identical to those of MicroLogic 5 A (see page B-12). They also offer a current-measurement function for this specific frequency.

Trip-Unit Selection

Rating	16	63	100	160	250	400	630
ComPacT							
NSX100	TM-D						
NSX160		TM-D					
NSX250				TM-D			
NSX100 to 250			MicroLogic 5.2 A-Z				
NSX400/630						MicroLogic 5.3 A-Z	

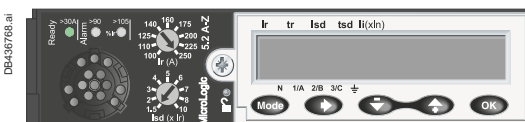

Wiring for NSX100 to 630 A

Phase and isolated neutral interrupted- 250/500 V

N and H (3P 3D version)

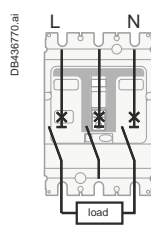

2 poles in series - Earthed neutral 250/500 V

N and H (3P 3D version)

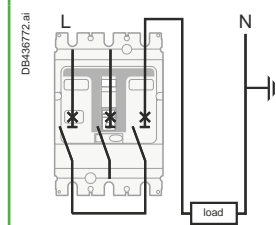

ComPacT NSXm Special Applications

Protection of 400 Hz Systems

ComPacT NSXm circuit breakers may be used on 400 Hz systems.

Breaking Capacity in 400 Hz, 440 V Systems

The power levels of 400 Hz applications rarely exceed a few hundred kW with relatively low short circuit current, generally not exceeding four times the rated current.

Circuit breaker	Max. Breaking Capacity at 400 Hz
NSXm	10 kA

Thermal-Magnetic Trip Units

Thermal-Magnetic trip units require the current rating (I_n) to be derated and the magnetic trip setting (I_i) to be increased.

Current Rating (I_n) and Magnetic Trip Setting (I_i) Rerating

Circuit breaker	Maximum setting Coefficient	Max I_r setting at 400 Hz	Magnetic I_i coefficient at 400 Hz
NSXm	0.9	144	1.6

Shunt Trip (MX) or Undervoltage Trip (MN) Voltage Release at 400 Hz and 440 V

Undervoltage releases (MN) rated 24 V AC/DC, 48 V AC/DC, or 110/130 V AC/DC are 400 Hz compliant with their nominal voltages. For voltages greater than 110/130 V AC/DC, please contact Schneider Electric for additional information. Shunt Trips (MX), please contact Schneider Electric.



ComPacT NSXm TM-D

C12H3TM160L.eps

B

ComPacT NSX Special Applications

Protection of 400 Hz Systems

ComPacT NSX circuit breakers may be used on 400 Hz systems.

B

C2532D350.eps



MicroLogic TM-D trip unit

400 Hz Distribution Systems

The main 400 Hz applications are in aeronautics and certain military ships. Modern aircraft have three-phase 115/200 V 400 Hz networks.

Impact on Protective Devices

Due to the higher frequency, circuit breakers are subjected to additional temperature rise for identical current levels, resulting from higher losses caused by Foucault currents and an increase in the skin effect (reduction in the useful CSA of conductors). To remain within the rated temperature-rise limits of devices, current derating is required.

The power levels of 400 Hz applications rarely exceed a few hundred kW with relatively low short-circuit currents, generally not exceeding four times the rated current.

The standard ComPacT NSX range is suitable for 400 Hz applications if derating coefficients are applied to the protection settings. See the derating table below.

Breaking Capacity of ComPacT NSX Circuit Breakers in 400 Hz, 440 V Systems

Circuit breaker	Breaking capacity I _{cu}
NSX100	10 kA
NSX160	10 kA
NSX250	10 kA
NSX400	10 kA
NSX630	10 kA

Trip Units Equipped with Thermal-Magnetic Protection

The 400 Hz current settings are obtained by multiplying the 50 Hz values by the following adaptation coefficient:

- K1 for thermal trip units
- K2 for magnetic trip units.

These coefficients are independent of the trip-unit setting.

Thermal trip units

The current settings are lower at 400 Hz than at 50 Hz ($K1 < 1$).

Magnetic trip units

The current settings are conversely higher at 400 Hz than at 50 Hz ($K2 > 1$).

Consequently, when the trip units are adjustable, they must be set to the minimum value.

Adaptation coefficients for thermal-magnetic trip units

Circuit breaker	Trip unit	In (A) 50Hz	Thermal at 40°C		Ii (A) 50Hz	Magnetic	
			K1	400 Hz		K2	400 Hz
NSX100	TM16G	16	0.95	15	63	1.6	100
	TM25G	25	0.95	24	80	1.6	130
	TM40G	40	0.95	38	80	1.6	130
	TM63G	63	0.95	60	125	1.6	200
NSX100	TM16D	16	0.95	15	240	1.6	300
	TM25D	25	0.95	24	300	1.6	480
	TM40D	40	0.95	38	500	1.6	800
	TM63D	63	0.95	60	500	1.6	800
	TM80D	80	0.9	72	650	1.6	1040
	TM100D	100	0.9	90	800	1.6	1280
	TM100D	100	0.9	90	800	1.6	1280
NSX160	TM80D	80	0.9	72	650	1.6	1040
	TM100D	100	0.9	90	800	1.6	1280
	TM125D	125	0.9	112.5	1250	1.6	2000
	TM160D	160	0.9	144	1250	1.6	2000
NSX250	TM100D	100	0.9	90	800	1.6	1280
	TM160D	160	0.9	144	1250	1.6	2000
	TM200D	200	0.9	180	1000 to 2000	1.6	1600 to 3200
	TM250D	250	0.9	225	1250 to 2500	1.6	2000 to 4000

Example

NSX100 equipped with a TM16G with 50 Hz settings $I_r = 16$ A and $I_i = 63$ A. 400 Hz settings $I_r = 16 \times 0.95 = 15$ A and $I_i = 63 \text{ A} \times 1.6 = 100$ A.

ComPacT NSX Special Applications

Protection of 400 Hz Systems

Protection

MicroLogic Electronic Trip Units

MicroLogic 2.2, 2.3 or 5.2, 5.3 with E measurement functions are suitable for 400 Hz. The use of electronics offers the advantage of greater operating stability when the frequency varies. However the units are still subject to temperature rise caused by the frequency.

The practical consequences are:

- Limit settings: see the I_r derating table below.
- The long-time, short-time and instantaneous pick-ups are not modified (see page B-10 or page B-12).
- The accuracy of the displayed measurements is 2 % (class II).

Thermal derating: maximum I_r setting

Circuit breaker	Maximum setting coefficient	Max. I _r setting at 400 Hz
NSX100	1	100
NSX250	0.9	225
NSX400	0.8	320
NSX630	0.63	400

Example

An NSX250N, equipped with a MicroLogic 2.2, I_r = 250 A at 50 Hz, must be limited to use at I_r = 250 x 0.9 = 225 A.

Its short-time pick-up with fixed time delay is adjustable from 1.5 to 10 I_r (337.5 to 2250 A).

The instantaneous pick-up remains at 3000 A.

OF Auxiliary Contacts in 400 Hz Networks

Electrical characteristics of auxiliary contacts

Contacts	Standard		Low level	
	AC12	AC15	AC12	AC15
Utilization cat. (IEC 60947-5-1)	AC12	AC15	AC12	AC15
Operational current ^{24 V} (A)	6	6	5	3
48 V	6	6	5	3
110 V	6	5	5	2.5
220/240 V	6	4	5	2
380/415 V	6	2	5	1.5

MN and MX Voltage Releases for ComPacT NSX100/630 at 400 Hz and 440 V

For circuit breakers on 400 Hz systems, only 125 V DC MN or MX releases may be used. The release must be supplied by the 400 Hz system via a rectifier bridge (to be selected from the table below) and an additional resistor with characteristics depending on the system voltage.

U (V) 400 Hz	Rectifier	Additional resistor
220/240 V	Thomson 110 BHZ or General Instrument W06 or Semikron SKB at 1.2/1.3	4.2 kΩ-5 W
380/420 V	Semikron SKB at 1.2/1.3	10.7 kΩ-10 W

Note: Other models of rectifier bridges may be used if their characteristics are at least equivalent to those stated above.

SDx Indication Contacts

The SDx module may be used in 400 Hz systems for voltages from 24 to 440 V. An SDx relay module installed inside the circuit breaker can be used to remote the overload-trip signal.

This module receives the signal from the MicroLogic electronic trip unit via an optical link and makes it available on the terminal block. The signal is cleared when the circuit breaker is closed.

These outputs can be reprogrammed to be assigned to other types of tripping or alarm (see page C-31).



MicroLogic 5 E trip unit

C2538E250.eps



OF auxiliary contact

LV28454.eps



MX or MN voltage release

PB1204658.eps

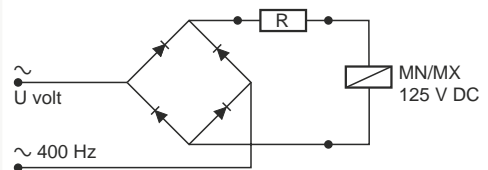

Wiring diagram

DB11579.eps



SDx remote indication relay module with its terminal block

PB103377.eps



B

ComPacT NSX Special Applications

ComPacT NSX400K at 1000 V AC

B

The ComPacT NSX range includes the NSX400K 3P and 4P at 800 VAC and 1000 VAC models, with adjustable electronic trip unit Micrologic 2.3 rating 250A and 400A.

The ComPacT NSX400K offers the following features of the ComPacT NSX range:

- Compliance with most standards
- Service breaking capacity of 10 kA at 1000 VAC and 36 kA at 800 VAC
- Suitable for isolation with positive break indication
- Accessories, MN, MX, ON/OFF, auxiliary, motor mechanism, rotary handles, locking kit and terminal shields.

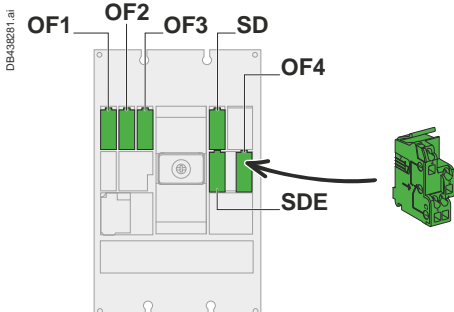

> Substitution and Technical Guide
ComPacT NSX High Performance



LVPED221004EN

Compliance with Standards

- International: IEC 60947-1 to 5
- Europe: EN 60947

Suitability for Isolation and People Safety

All Compact circuit-breakers are suitable for isolation as defined in IEC standard 60947-2. The operating handle cannot indicate the "off" position unless the contacts are actually open. Fitting a rotary handle or a motor mechanism does not alter the reliability of the position indication system.

For protection against direct contact with live parts, Compact circuit breakers may be installed through the door of Class II switchboards (as per IEC 60664).

Electrical Characteristics

Number of poles	3 & 4		
IEC 60947-2 and EN 60947-2			
Rated insulation voltage	Ui (VAC)	1000	
Rated impulse withstand voltage	Uimp (kV)	8	
Rated operational voltage	Ue (V)	AC 50/60 Hz	1000
Ultimate breaking capacity	Icu (kA rms)	AC 1000 V	10
		AC 800 V	36
Service breaking capacity	Ics (% Icu)	AC 1000 V	10
		AC 800 V	10
Suitability for isolation	■		
Utilization category	A		
Pollution degree	3		

Electronic Trip Unit

Factory mounted	Refer to Micrologic 2.3 section for trip settings
-----------------	---

Auxiliaries for Indication, Measurement and Control

- Direct or extended rotary handles
- Padlocking and keylocking devices
- Motor mechanism featuring short closing time
- Status indication auxiliary contacts (contact positions, tripped, electrical fault, earth fault)
- Shunt and undervoltage auxiliary releases

ComPacT NSX Special Applications

ComPacT NSX400K at 1000 V AC

Safety Parameters

Fixed front connection.

Supply by the top or the bottom. Connection by cables or busbars.

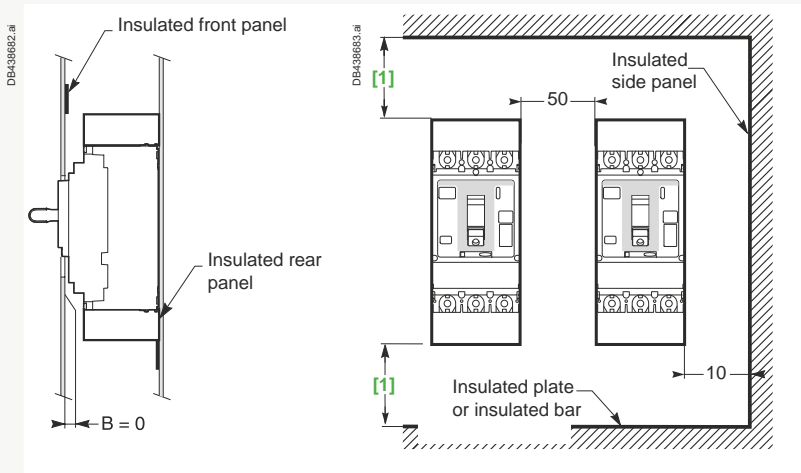

[1] 50 mm with short terminal shield
30 mm with long terminal shield.

Note: Long or short terminal shield are mandatory.

B

Order your ComPacT NSX and NSXm Through Digital Tools Product Selector

Go on the range page on www.schneider-electric.com



To select your ComPacT NSX, use the product selector available at <https://www.se.com/ww/en/work/support/product-selector/>.

Catalog Numbers

ComPacT NSXm.....	F-3
ComPacT NSX100-250	F-15
ComPacT NSX400-630	F-49
Source-Changeover Systems for 2 Devices ComPacT NSX100 to NSX630.....	F-72
NSX100/400 for Utilities, "Tarif Jaune" Public Distribution.....	F-74
Order Form	F-78



Other Chapters	
Select Circuit Breakers and Switch-Disconnectors	A-1
Select Protection	B-1
Customize Circuit Breakers with Accessories.....	C-1
Smart Panel Integration	D-1
Switchboard Integration.....	E-1
Glossary	G-1
Additional Characteristics.....	H-1



Catalog Numbers: ComPacT NSXm

Complete Fixed Device

ComPacT NSXm E/B (16/25 KA at 380/415 V).....	F-4
ComPacT NSXm F/N (36/50 KA at 380/415 V).....	F-5
ComPacT NSXm H (70 KA at 380/415 V).....	F-6
ComPacT NSXm MicroLogic Vigi 4.1 E/B/F (16/25/36 KA at 380/415 V).....	F-7
ComPacT NSXm MicroLogic Vigi 4.1 N/H (50/70 KA at 380/415 V).....	F-8
ComPacT NSXm NA.....	F-9

Accessories

Connection and Insulation.....	F-10
Electrical Auxiliaries.....	F-11
Rotary Handles, Locks and Seals.....	F-12
Spare Parts, Test Tool and Software.....	F-13

Other Chapters

Select Circuit Breakers and Switch-Disconnectors.....	A-1
Select Protection.....	B-1
Customize Circuit Breakers with Accessories.....	C-1
Smart Panel Integration.....	D-1
Switchboard Integration.....	E-1
Glossary.....	G-1
Additional Characteristics.....	H-1

Complete Fixed Device

ComPacT NSXm E/B (16/25 KA at 380/415 V)

ComPacT NSXm E (16 KA at 380/415 V)

With thermal-magnetic trip unit TM-D

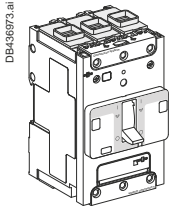

EverLink™ connectors

Rating	3P	4P 3d	4P 4d
TM16D	C11E3TM016L	C11E6TM016L	C11E4TM016L
TM25D	C11E3TM025L	C11E6TM025L	C11E4TM025L
TM32D	C11E3TM032L	C11E6TM032L	C11E4TM032L
TM40D	C11E3TM040L	C11E6TM040L	C11E4TM040L
TM50D	C11E3TM050L	C11E6TM050L	C11E4TM050L
TM63D	C11E3TM063L	C11E6TM063L	C11E4TM063L
TM80D	C11E3TM080L	C11E6TM080L	C11E4TM080L
TM100D	C11E3TM100L	C11E6TM100L	C11E4TM100L
TM125D	C12E3TM125L	C12E6TM125L	C12E4TM125L
TM160D	C12E3TM160L	C12E6TM160L	C12E4TM160L

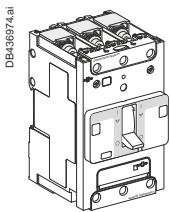

Compression lug/busbar connectors

Rating	3P	4P 3d	4P 4d
TM16D	C11E3TM016B	C11E6TM016B	C11E4TM016B
TM25D	C11E3TM025B	C11E6TM025B	C11E4TM025B
TM32D	C11E3TM032B	C11E6TM032B	C11E4TM032B
TM40D	C11E3TM040B	C11E6TM040B	C11E4TM040B
TM50D	C11E3TM050B	C11E6TM050B	C11E4TM050B
TM63D	C11E3TM063B	C11E6TM063B	C11E4TM063B
TM80D	C11E3TM080B	C11E6TM080B	C11E4TM080B
TM100D	C11E3TM100B	C11E6TM100B	C11E4TM100B
TM125D	C12E3TM125B	C12E6TM125B	C12E4TM125B
TM160D	C12E3TM160B	C12E6TM160B	C12E4TM160B

ComPacT NSXm B (25 KA at 380/415 V)

With thermal-magnetic trip unit TM-D

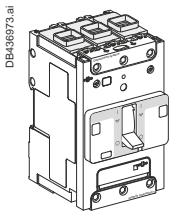

EverLink™ connectors

Rating	3P	4P 3d	4P 4d
TM16D	C11B3TM016L	C11B6TM016L	C11B4TM016L
TM25D	C11B3TM025L	C11B6TM025L	C11B4TM025L
TM32D	C11B3TM032L	C11B6TM032L	C11B4TM032L
TM40D	C11B3TM040L	C11B6TM040L	C11B4TM040L
TM50D	C11B3TM050L	C11B6TM050L	C11B4TM050L
TM63D	C11B3TM063L	C11B6TM063L	C11B4TM063L
TM80D	C11B3TM080L	C11B6TM080L	C11B4TM080L
TM100D	C11B3TM100L	C11B6TM100L	C11B4TM100L
TM125D	C12B3TM125L	C12B6TM125L	C12B4TM125L
TM160D	C12B3TM160L	C12B6TM160L	C12B4TM160L

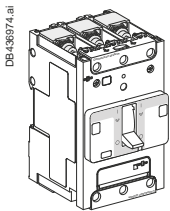

Compression lug/busbar connectors

Rating	3P	4P 3d	4P 4d
TM16D	C11B3TM016B	C11B6TM016B	C11B4TM016B
TM25D	C11B3TM025B	C11B6TM025B	C11B4TM025B
TM32D	C11B3TM032B	C11B6TM032B	C11B4TM032B
TM40D	C11B3TM040B	C11B6TM040B	C11B4TM040B
TM50D	C11B3TM050B	C11B6TM050B	C11B4TM050B
TM63D	C11B3TM063B	C11B6TM063B	C11B4TM063B
TM80D	C11B3TM080B	C11B6TM080B	C11B4TM080B
TM100D	C11B3TM100B	C11B6TM100B	C11B4TM100B
TM125D	C12B3TM125B	C12B6TM125B	C12B4TM125B
TM160D	C12B3TM160B	C12B6TM160B	C12B4TM160B

F

Complete Fixed Device

ComPacT NSXm F/N (36/50 KA at 380/415 V)

ComPacT NSXm F (36 KA at 380/415 V)

With thermal-magnetic trip unit TM-D

DB-436973.ai

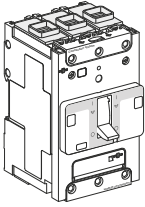

EverLink™ connectors

Rating	3P	4P 3d	4P 4d
TM16D	C11F3TM016L	C11F6TM016L	C11F4TM016L
TM25D	C11F3TM025L	C11F6TM025L	C11F4TM025L
TM32D	C11F3TM032L	C11F6TM032L	C11F4TM032L
TM40D	C11F3TM040L	C11F6TM040L	C11F4TM040L
TM50D	C11F3TM050L	C11F6TM050L	C11F4TM050L
TM63D	C11F3TM063L	C11F6TM063L	C11F4TM063L
TM80D	C11F3TM080L	C11F6TM080L	C11F4TM080L
TM100D	C11F3TM100L	C11F6TM100L	C11F4TM100L
TM125D	C12F3TM125L	C12F6TM125L	C12F4TM125L
TM160D	C12F3TM160L	C12F6TM160L	C12F4TM160L

DB-436974.ai

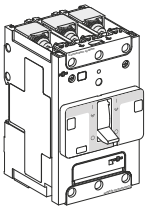

Compression lug/busbar connectors

Rating	3P	4P 3d	4P 4d
TM16D	C11F3TM016B	C11F6TM016B	C11F4TM016B
TM25D	C11F3TM025B	C11F6TM025B	C11F4TM025B
TM32D	C11F3TM032B	C11F6TM032B	C11F4TM032B
TM40D	C11F3TM040B	C11F6TM040B	C11F4TM040B
TM50D	C11F3TM050B	C11F6TM050B	C11F4TM050B
TM63D	C11F3TM063B	C11F6TM063B	C11F4TM063B
TM80D	C11F3TM080B	C11F6TM080B	C11F4TM080B
TM100D	C11F3TM100B	C11F6TM100B	C11F4TM100B
TM125D	C12F3TM125B	C12F6TM125B	C12F4TM125B
TM160D	C12F3TM160B	C12F6TM160B	C12F4TM160B

ComPacT NSXm N (50 KA at 380/415 V)

With thermal-magnetic trip unit TM-D

DB-436973.ai

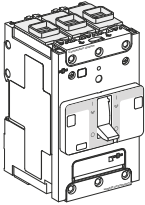

EverLink™ connectors

Rating	3P	4P 3d	4P 4d
TM16D	C11N3TM016L	C11N6TM016L	C11N4TM016L
TM25D	C11N3TM025L	C11N6TM025L	C11N4TM025L
TM32D	C11N3TM032L	C11N6TM032L	C11N4TM032L
TM40D	C11N3TM040L	C11N6TM040L	C11N4TM040L
TM50D	C11N3TM050L	C11N6TM050L	C11N4TM050L
TM63D	C11N3TM063L	C11N6TM063L	C11N4TM063L
TM80D	C11N3TM080L	C11N6TM080L	C11N4TM080L
TM100D	C11N3TM100L	C11N6TM100L	C11N4TM100L
TM125D	C12N3TM125L	C12N6TM125L	C12N4TM125L
TM160D	C12N3TM160L	C12N6TM160L	C12N4TM160L

DB-436974.ai

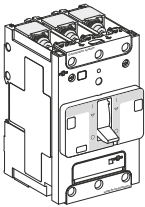

Compression lug/busbar connectors

Rating	3P	4P 3d	4P 4d
TM16D	C11N3TM016B	C11N6TM016B	C11N4TM016B
TM25D	C11N3TM025B	C11N6TM025B	C11N4TM025B
TM32D	C11N3TM032B	C11N6TM032B	C11N4TM032B
TM40D	C11N3TM040B	C11N6TM040B	C11N4TM040B
TM50D	C11N3TM050B	C11N6TM050B	C11N4TM050B
TM63D	C11N3TM063B	C11N6TM063B	C11N4TM063B
TM80D	C11N3TM080B	C11N6TM080B	C11N4TM080B
TM100D	C11N3TM100B	C11N6TM100B	C11N4TM100B
TM125D	C12N3TM125B	C12N6TM125B	C12N4TM125B
TM160D	C12N3TM160B	C12N6TM160B	C12N4TM160B

F

Complete Fixed Device

ComPacT NSXm H (70 KA at 380/415 V)

ComPacT NSXm H (70 KA at 380/415 V)

With thermal-magnetic trip unit TM-D

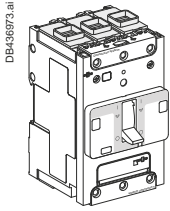

EverLink™ connectors

Rating	3P	4P 3d	4P 4d
TM16D	C11H3TM016L	C11H6TM016L	C11H4TM016L
TM25D	C11H3TM025L	C11H6TM025L	C11H4TM025L
TM32D	C11H3TM032L	C11H6TM032L	C11H4TM032L
TM40D	C11H3TM040L	C11H6TM040L	C11H4TM040L
TM50D	C11H3TM050L	C11H6TM050L	C11H4TM050L
TM63D	C11H3TM063L	C11H6TM063L	C11H4TM063L
TM80D	C11H3TM080L	C11H6TM080L	C11H4TM080L
TM100D	C11H3TM100L	C11H6TM100L	C11H4TM100L
TM125D	C12H3TM125L	C12H6TM125L	C12H4TM125L
TM160D	C12H3TM160L	C12H6TM160L	C12H4TM160L

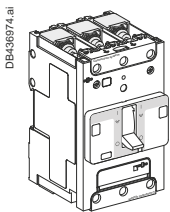

Compression lug/busbar connectors

Rating	3P	4P 3d	4P 4d
TM16D	C11H3TM016B	C11H6TM016B	C11H4TM016B
TM25D	C11H3TM025B	C11H6TM025B	C11H4TM025B
TM32D	C11H3TM032B	C11H6TM032B	C11H4TM032B
TM40D	C11H3TM040B	C11H6TM040B	C11H4TM040B
TM50D	C11H3TM050B	C11H6TM050B	C11H4TM050B
TM63D	C11H3TM063B	C11H6TM063B	C11H4TM063B
TM80D	C11H3TM080B	C11H6TM080B	C11H4TM080B
TM100D	C11H3TM100B	C11H6TM100B	C11H4TM100B
TM125D	C12H3TM125B	C12H6TM125B	C12H4TM125B
TM160D	C12H3TM160B	C12H6TM160B	C12H4TM160B

Complete Fixed Device

ComPacT NSXm MicroLogic Vigi 4.1 E/B/F

(16/25/36 KA at 380/415 V)

ComPacT NSXm MicroLogic Vigi 4.1 E (16 KA at 380/415 V)

With MicroLogic Vigi 4.1

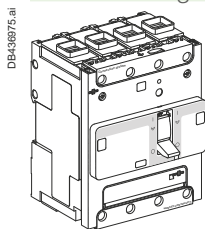

EverLink™ connectors

Rating	3P	4P
25 A	C11E34V025L	C11E44V025L
50 A	C11E34V050L	C11E44V050L
100 A	C11E34V100L	C11E44V100L
160 A	C12E34V160L	C12E44V160L

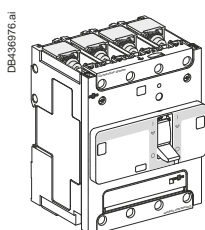

Compression lug/busbar connectors

Rating	3P	4P
25 A	C11E34V025B	C11E44V025B
50 A	C11E34V050B	C11E44V050B
100 A	C11E34V100B	C11E44V100B
160 A	C12E34V160B	C12E44V160B

ComPacT NSXm MicroLogic Vigi 4.1 B (25 KA at 380/415 V)

With MicroLogic Vigi 4.1

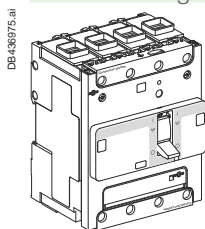

EverLink™ connectors

Rating	3P	4P
25 A	C11B34V025L	C11B44V025L
50 A	C11B34V050L	C11B44V050L
100 A	C11B34V100L	C11B44V100L
160 A	C12B34V160L	C12B44V160L

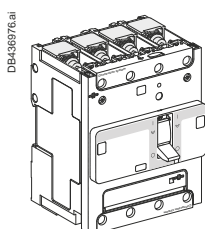

Compression lug/busbar connectors

Rating	3P	4P
25 A	C11B34V025B	C11B44V025B
50 A	C11B34V050B	C11B44V050B
100 A	C11B34V100B	C11B44V100B
160 A	C12B34V160B	C12B44V160B

ComPacT NSXm MicroLogic Vigi 4.1 F (36 KA at 380/415 V)

With MicroLogic Vigi 4.1

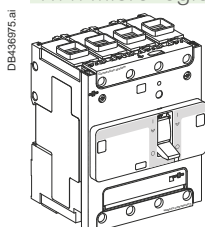

EverLink™ connectors

Rating	3P	4P
25 A	C11F34V025L	C11F44V025L
50 A	C11F34V050L	C11F44V050L
100 A	C11F34V100L	C11F44V100L
160 A	C12F34V160L	C12F44V160L

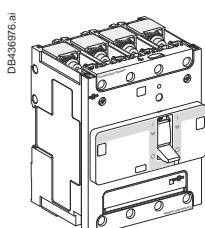

Compression lug/busbar connectors

Rating	3P	4P
25 A	C11F34V025B	C11F44V025B
50 A	C11F34V050B	C11F44V050B
100 A	C11F34V100B	C11F44V100B
160 A	C12F34V160B	C12F44V160B



Complete Fixed Device

ComPacT NSXm MicroLogic Vigi 4.1 N/H (50/70 KA at 380/415 V)

ComPacT NSXm MicroLogic Vigi 4.1 N (50 KA at 380/415 V)

With MicroLogic Vigi 4.1

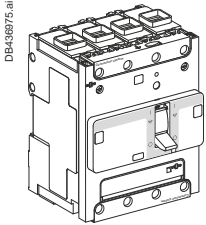

EverLink™ connectors		
Rating	3P	4P
25 A	C11N34V025L	C11N44V025L
50 A	C11N34V050L	C11N44V050L
100 A	C11N34V100L	C11N44V100L
160 A	C12N34V160L	C12N44V160L

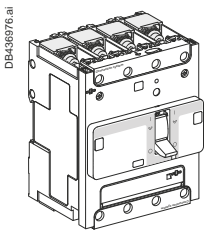

Compression lug/busbar connectors		
Rating	3P	4P
25 A	C11N34V025B	C11N44V025B
50 A	C11N34V050B	C11N44V050B
100 A	C11N34V100B	C11N44V100B
160 A	C12N34V160B	C12N44V160B

ComPacT NSXm MicroLogic Vigi 4.1 H (70 KA at 380/415 V)

With MicroLogic Vigi 4.1

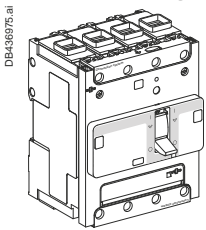

EverLink™ connectors		
Rating	3P	4P
25 A	C11H34V025L	C11H44V025L
50 A	C11H34V050L	C11H44V050L
100 A	C11H34V100L	C11H44V100L
160 A	C12H34V160L	C12H44V160L

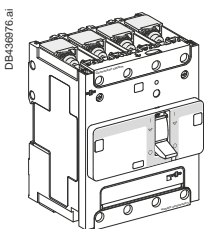

Compression lug/busbar connectors		
Rating	3P	4P
25 A	C11H34V025B	C11H44V025B
50 A	C11H34V050B	C11H44V050B
100 A	C11H34V100B	C11H44V100B
160 A	C12H34V160B	C12H44V160B

F

ComPacT NSXm NA Switch-Disconnecter

DB438973.ai

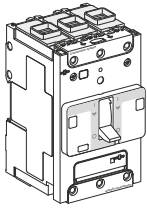

EverLink™ connectors		
Rating	3P	4P
50NA	C113050LS	C114050LS
100NA	C113100LS	C114100LS
160NA	C123160LS	C124160LS

DB438974.ai

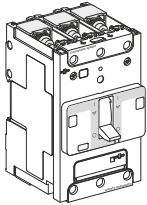

Compression lug/busbar connectors		
Rating	3P	4P
50NA	C113050BS	C114050BS
100NA	C113100BS	C114100BS
160NA	C123160BS	C124160BS



Accessories

Connection and Insulation

Connection Accessories (Cu or Al)

Bare cable connectors

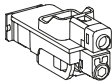
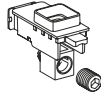
 DB421533.eps	Everlink connector with control wire terminal	1x (2.5 to 95 mm ²) ; ≤ 160 A Cu or ≤ 100 A Al	Set of 3	LV426970
			Set of 4	LV426971
 DB418793.eps	Aluminium connector	1x (2.5 to 70 mm ²) ; ≤ 125 A Cu or Al	Set of 2	LV426966
			Set of 3	LV426967

Compression lugs/busbar connectors

 DB421537.eps	Terminal with nuts and screws M6	≤ 160 A	Set of 3	LV426960
			Set of 4	LV426961

Terminal extensions

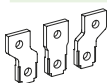
 DB421538.eps	Spreaders from 27 to 35 mm pitch ^[1]	3P	LV426940
		4P	LV426941

Crimp lugs for copper cable ^[1]

 DB421538.eps	For cable 50 mm ²	Set of 3	LV426978
		Set of 4	LV426979
	For cable 70 mm ²	Set of 3	LV426980
		Set of 4	LV426981
	For cable 95 mm ²	Set of 3	LV426982
		Set of 4	LV426983

Crimp lugs for aluminium cable ^[1]

 DB421540.eps	For cable 95 mm ² rigid	Set of 3	LV426984
		Set of 4	LV426985
	For cable 120 mm ² rigid	Set of 3	LV426976
		Set of 4	LV426977

Torque limiting breakaway bits

 DB421541.eps	9 N.m	Set of 6	LV426990
		Set of 8	LV426991
	5 N.m	Set of 6	LV426992
		Set of 8	LV426993

Insulation Accessories

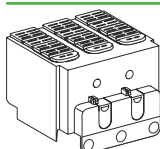
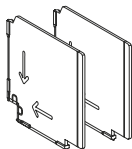
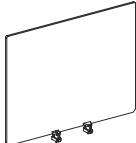
 DB421542.eps	1 long terminal shield	3P	LV426912
		4P	LV426913
 DB421543.eps	Interphase barriers	Set of 6	LV426920
 DB421544.eps	2 rear insulation screens	3P	LV426922
		4P	LV426923

[1] Supplied with 2 or 3 interphase barriers.

F

Electrical Auxiliaries

Auxiliary contacts (wired, screwless)



Standard OF or SD	LV426950
-------------------	----------

Auxiliary contacts (wireless)



Zigbee auxiliary contact	LV429453
--------------------------	----------



Pre-wired OF ^[1]	LV426951
Pre-wired SD ^[1]	LV426952

SDx for MicroLogic Vigi 4.1

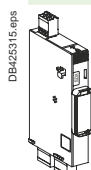

SDx module 24-250 V AC/DC	LV426900
---------------------------	----------

Voltage releases



Standard	Voltage	MX	MN		
AC	24 V 50/60 Hz	LV426841	LV426801		
	48 V 50/60 Hz	LV426842	LV426802		
	110...130 V 50/60 Hz	LV426843	LV426803		
	220...240 V 50 Hz	LV426844	LV426804		
	208...240 V 60 Hz				
	277 V 60 Hz	LV426844	LV426805		
	380...415 V 50 Hz	LV426846	LV426806		
	440...480 V 60 Hz	LV426846	LV426807		
DC	12 V DC	LV426850	-		
	24 V DC	LV426841	LV426801		
	48 V DC	LV426842	LV426802		
	125 V DC	LV426843	LV426803		
	250 V DC	LV426844	LV426815		
Pre-wired ^[1]	Voltage	MX	MN		
		AC	24 V 50/60 Hz	LV426861	LV426821
			48 V 50/60 Hz	LV426862	LV426822
			110...130 V 50/60 Hz	LV426863	LV426823
			220...240 V 50 Hz	LV426864	LV426824
			208...240 V 60 Hz		
			277 V 60 Hz	LV426864	LV426825
			380...415 V 50 Hz	LV426866	LV426826
			440...480 V 60 Hz	LV426866	LV426827
		DC	12 V DC	LV426870	-
			24 V DC	LV426861	LV426821
			48 V DC	LV426862	LV426822
			125 V DC	LV426863	LV426823
			250 V DC	LV426864	LV426835



Time delay unit for undervoltage release (MN)

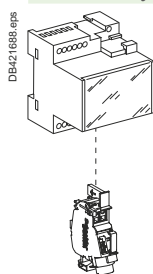

MN 48 V 50/60 Hz with fixed time delay		
Composed of:	MN 48 V DC	LV426802
	Delay unit 48 V 50/60 Hz	LV429426
MN 220-240 V 50/60 Hz with fixed time delay		
Composed of:	MN 250 V DC	LV426815
	Delay unit 220-240 V 50/60 Hz	LV429427
MN 48 V DC/AC 50/60 Hz with adjustable time delay		
Composed of:	MN 48 V DC	LV426802
	Delay unit 48 V DC/AC 50/60 Hz	33680
MN 110-130 V DC/AC 50/60 Hz with adjustable time delay		
Composed of:	MN 125 V DC	LV426803
	Delay unit 100-130 V DC/AC 50/60 Hz	33681
MN 220-250 V DC/AC 50/60 Hz with adjustable time delay		
Composed of:	MN 250 V DC	LV426815
	Delay unit 200-250 V DC/AC 50-60 Hz	33682

[1] Cable: 1 meter long - AWG 18 - 480 V UL certified.



Accessories

Rotary Handles, Locks and Seals

Rotary Handle

Direct rotary handle

DB438286.ai

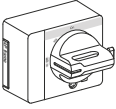

With black handle	LV426930T
With red handle on yellow front	LV426931T

Extended rotary handle

DB438287.ai

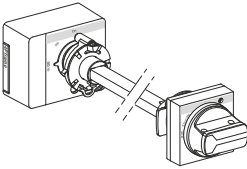

With black handle IP54	LV426932T
With red handle on yellow front IP54	LV426933T
With red handle on yellow front IP65	LV426934T

DB421689.eps



Open door shaft operator	LV426937
--------------------------	----------

DB421677.eps



Laser tool	GVAPL01
------------	---------

Side rotary handle

DB438288.ai

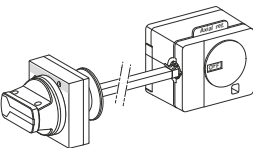

With black handle IP54	LV426935T
With red handle on yellow front IP54	LV426936T

Universal handle

DB438289.ai



Black handle IP54 (spare part for replacement of front, ext. or side rotary handle)	LV426997T
Red handle on yellow front IP54	LV426998T
Red handle on yellow front IP65	LV426999T

Locks

Toggle locking device for 1 to 3 padlocks

DB425851.eps

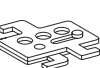

By removable device	29370
---------------------	-------

DB421555.eps



By fixed device (OFF or ON)	LV426905
-----------------------------	----------

DB421690.eps



By fixed device (OFF only)	LV426906
----------------------------	----------

Lead - Sealing Accessories

DB421556.eps

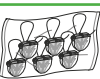

Bag of accessories	LV429375
--------------------	----------

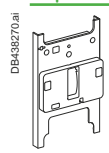
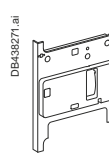
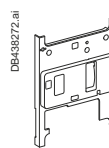

F

Spare Parts

	Front cover	3P	LV426946
		4P	LV426947
		ELCB ^[1]	LV426948

Test Tool, Software, Demo

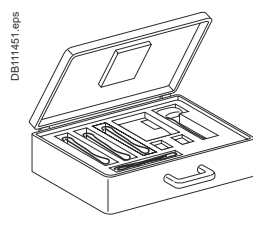
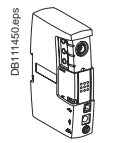
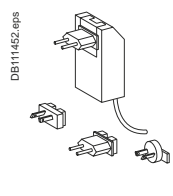
Test tool

	Pocket battery for MicroLogic	LV434206
	Maintenance case Comprising: <ul style="list-style-type: none"> ■ USB maintenance interface ■ Power supply ■ MicroLogic cord ■ USB cord ■ RJ45/RJ45 male cord 	TRV00910
	Spare USB maintenance interface	TRV00911
	Spare power supply 110-240 V AC	TRV00915
	Spare MicroLogic cord for USB maintenance interface	TRV00917

[1] ELCB: Earth Leakage Circuit Breaker.





F

Catalog Numbers: ComPacT NSX100-250

Complete Fixed Device

ComPacT NSX100/160 1P-2P NSX250N 1P	F-16
ComPacT NSX100/160/250B (25 KA 380/415 V)	F-17
ComPacT NSX100/160/250F (36 KA 380/415 V)	F-18
ComPacT NSX100/160/250N (50 KA 380/415 V)	F-20
ComPacT NSX100/160/250H (70 KA 380/415 V)	F-22
ComPacT NSX100/250R (200 KA 380/415 V - 45 KA 690 V)	F-24
ComPacT NSX100/250HB1 (85 KA 500 V - 75 KA 690 V)	F-26
ComPacT NSX100/250HB2 (100 KA 500 V - 100 KA 690 V)	F-28
ComPacT NSX100/160/250NA	F-30

Based on Separate Components

ComPacT NSX100/160/250	F-31
------------------------------	------

Trip Unit Accessories

ComPacT NSX100/160/250	F-34
------------------------------	------

Installation and Connection

ComPacT NSX100/160/250	F-35
------------------------------	------

Accessories and Auxiliaries

ComPacT NSX100/160/250	F-36
------------------------------	------

Other Chapters

Select Circuit Breakers and Switch-Disconnectors	A-1
Select Protection	B-1
Customize Circuit Breakers with Accessories	C-1
Smart Panel Integration	D-1
Switchboard Integration	E-1
Glossary	G-1
Additional Characteristics	H-1

Complete Fixed Device

ComPacT NSX100/160 1P-2P NSX250N 1P

ComPacT NSX100/160 F/N/M/S 1P/2P

With thermal-magnetic trip unit TM-D

DB438977.ai

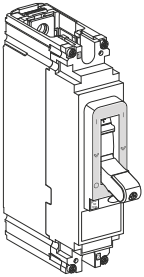

ComPacT NSX100F AC/DC

Rating	1P 1d (Icu = 18 kA 220/240 V AC)
TM16D	C10F1TM016
TM20D	C10F1TM020
TM25D	C10F1TM025
TM30D	C10F1TM030
TM40D	C10F1TM040
TM50D	C10F1TM050
TM63D	C10F1TM063
TM80D	C10F1TM080
TM100D	C10F1TM100

ComPacT NSX100F AC/DC

Rating	2P 2d (Icu = 18 kA 380/415 V AC)
	C10F2TM016
	C10F2TM020
	C10F2TM025
	C10F2TM030
	C10F2TM040
	C10F2TM050
	C10F2TM063
	C10F2TM080
	C10F2TM100

ComPacT NSX160F AC/DC

Rating	1P 1d (Icu = 18 kA 220/240 V AC)
TM125D	C16F1TM125
TM160D	C16F1TM160

ComPacT NSX160F AC/DC

Rating	2P 2d (Icu = 18 kA 380/415 V AC)
	C16F2TM125
	C16F2TM160

ComPacT NSX100N AC/DC

Rating	1P 1d (Icu = 25 kA 220/240 V AC)
TM16D	C10N1TM016
TM20D	C10N1TM020
TM25D	C10N1TM025
TM30D	C10N1TM030
TM40D	C10N1TM040
TM50D	C10N1TM050
TM63D	C10N1TM063
TM80D	C10N1TM080
TM100D	C10N1TM100

ComPacT NSX100M AC/DC

Rating	2P 2d (Icu = 25 kA 380/415 V AC)
	C10M2TM016
	C10M2TM020
	C10M2TM025
	C10M2TM030
	C10M2TM040
	C10M2TM050
	C10M2TM063
	C10M2TM080
	C10M2TM100

ComPacT NSX160N AC/DC

Rating	1P 1d (Icu = 25 kA 220/240 V AC)
TM125D	C16N1TM125
TM160D	C16N1TM160

ComPacT NSX160M AC/DC

Rating	2P 2d (Icu = 40 kA 380/415 V AC)
	C16M2TM125
	C16M2TM160

ComPacT NSX100M AC/DC

Rating	1P 1d (Icu = 40 kA 220/240 V AC)
TM16D	C10M1TM016
TM20D	C10M1TM020
TM25D	C10M1TM025
TM30D	C10M1TM030
TM40D	C10M1TM040
TM50D	C10M1TM050
TM63D	C10M1TM063
TM80D	C10M1TM080
TM100D	C10M1TM100

ComPacT NSX100S AC/DC

Rating	2P 2d (Icu = 70 kA 380/415 V AC)
	C10S2TM016
	C10S2TM020
	C10S2TM025
	C10S2TM030
	C10S2TM040
	C10S2TM050
	C10S2TM063
	C10S2TM080
	C10S2TM100

ComPacT NSX160M AC/DC

Rating	1P 1d (Icu = 40 kA 220/240 V AC)
TM125D	C16M1TM125
TM160D	C16M1TM160

ComPacT NSX160S AC/DC

Rating	2P 2d (Icu = 70 kA 380/415 V AC)
	C16S2TM125
	C16S2TM160

ComPacT NSX250 N 1P

With thermal-magnetic trip unit TM-D

ComPacT NSX250N AC

Rating	1P 1d (Icu = 25 kA 220/240 V AC)
TM160D	C25N1TM160
TM200D	C25N1TM200
TM250D	C25N1TM250

F

Complete Fixed Device

ComPacT NSX100/160/250B (25 KA 380/415 V)

ComPacT NSX100/160/250B

With thermal-magnetic trip unit TM-D

DB-43166.ai

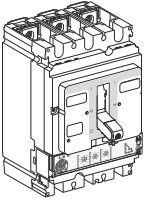

ComPacT NSX100B (25 kA at 380/415 V)			
Rating	3P 3d	4P 3d	4P 4d
TM16D	C10B3TM016	C10B6TM016	C10B4TM016
TM25D	C10B3TM025	C10B6TM025	C10B4TM025
TM32D	C10B3TM032	C10B6TM032	C10B4TM032
TM40D	C10B3TM040	C10B6TM040	C10B4TM040
TM50D	C10B3TM050	C10B6TM050	C10B4TM050
TM63D	C10B3TM063	C10B6TM063	C10B4TM063
TM80D	C10B3TM080	C10B6TM080	C10B4TM080
TM100D	C10B3TM100	C10B6TM100	C10B4TM100
ComPacT NSX160B (25 kA at 380/415 V)			
Rating	3P 3d	4P 3d	4P 4d
TM80D	C16B3TM080	C16B6TM080	C16B4TM080
TM100D	C16B3TM100	C16B6TM100	C16B4TM100
TM125D	C16B3TM125	C16B6TM125	C16B4TM125
TM160D	C16B3TM160	C16B6TM160	C16B4TM160
ComPacT NSX250B (25 kA at 380/415 V)			
Rating	3P 3d	4P 3d	4P 4d
TM125D	C25B3TM125	C25B6TM125	C25B4TM125
TM160D	C25B3TM160	C25B6TM160	C25B4TM160
TM200D	C25B3TM200	C25B6TM200	C25B4TM200
TM250D	C25B3TM250	C25B6TM250	C25B4TM250

With electronic trip unit MicroLogic 2.2 (LS_oI protection)

DB-43167.ai

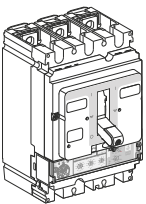

ComPacT NSX100B (25 kA at 380/415 V)		
Rating	3P 3d	4P 3d, 4d, 3d + N/2
40	C10B32D040	C10B42D040
100	C10B32D100	C10B42D100
ComPacT NSX160B (25 kA at 380/415 V)		
Rating	3P 3d	4P 3d, 4d, 3d + N/2
100	C16B32D100	C16B42D100
160	C16B32D160	C16B42D160
ComPacT NSX250B (25 kA at 380/415 V)		
Rating	3P 3d	4P 3d, 4d, 3d + N/2
100	C25B32D100	C25B42D100
160	C25B32D160	C25B42D160
250	C25B32D250	C25B42D250

With electronic trip unit MicroLogic Vigi 4.2 (LS_oIR protection)

DB-43168.ai

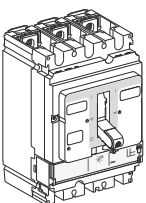

ComPacT NSX100B (25 kA 380/415V)		
Rating	3P 3d	4P 4d, 3d + N/2
40 A	C10B34V040	C10B44V040
100 A	C10B34V100	C10B44V100
ComPacT NSX160B (25 kA 380/415V)		
Rating	3P 3d	4P 4d, 3d + N/2
100 A	C16B34V100	C16B44V100
160 A	C16B34V160	C16B44V160
ComPacT NSX250B (25 kA 380/415V)		
Rating	3P 3d	4P 4d, 3d + N/2
100 A	C25B34V100	C25B44V100
160 A	C25B34V160	C25B44V160
250 A	C25B34V250	C25B44V250

With electronic trip unit MicroLogic Vigi 7.2 E (LSIR protection)

DB-43567.ai

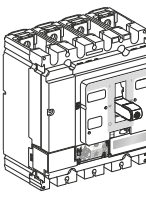

ComPacT NSX100B (25 kA 380/415V)		
Rating	3P 3d	4P 3d, 4d, 3d + N/2
40 A	-	C10B47E040
100 A	-	C10B47E100
ComPacT NSX160B (25 kA 380/415V)		
Rating	3P 3d	4P 3d, 4d, 3d + N/2
100 A	-	C16B47E100
160 A	-	C16B47E160
ComPacT NSX250B (25 kA 380/415V)		
Rating	3P 3d	4P 3d, 4d, 3d + N/2
100 A	-	C25B47E100
160 A	-	C25B47E160
250 A	-	C25B47E250

With electronic trip unit MicroLogic 5.2 E (LSI protection, energy meter)

Only available as separate component or through online configurator (product selector)

With electronic trip unit MicroLogic 6.2 E (LSIG protection, energy meter)

Only available as separate component or through online configurator (product selector)

With electronic trip unit MicroLogic 7.2 E (LSIG protection, energy meter)

Only available as separate component or through online configurator (product selector)



Complete Fixed Device

ComPacT NSX100/160/250F (36 kA 380/415 V)

ComPacT NSX100/160/250F

With thermal-magnetic trip unit TM-D

DB438165.ai

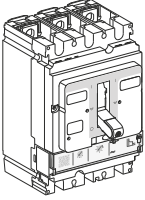

ComPacT NSX100F (36 kA at 380/415 V)

Rating	3P 3d	4P 3d	4P 4d
TM16D	C10F3TM016	C10F6TM016	C10F4TM016
TM25D	C10F3TM025	C10F6TM025	C10F4TM025
TM32D	C10F3TM032	C10F6TM032	C10F4TM032
TM40D	C10F3TM040	C10F6TM040	C10F4TM040
TM50D	C10F3TM050	C10F6TM050	C10F4TM050
TM63D	C10F3TM063	C10F6TM063	C10F4TM063
TM80D	C10F3TM080	C10F6TM080	C10F4TM080
TM100D	C10F3TM100	C10F6TM100	C10F4TM100

ComPacT NSX160F (36 kA at 380/415 V)

Rating	3P 3d	4P 3d	4P 4d
TM80D	C16F3TM080	C16F6TM080	C16F4TM050
TM100D	C16F3TM100	C16F6TM100	C16F4TM100
TM125D	C16F3TM125	C16F6TM125	C16F4TM125
TM160D	C16F3TM160	C16F6TM160	C16F4TM160

ComPacT NSX250F (36 kA at 380/415 V)

Rating	3P 3d	4P 3d	4P 4d
TM125D	C25F3TM125	C25F6TM125	C25F4TM125
TM160D	C25F3TM160	C25F6TM160	C25F4TM160
TM200D	C25F3TM200	C25F6TM200	C25F4TM200
TM250D	C25F3TM250	C25F6TM250	C25F4TM250

With electronic trip unit MicroLogic 2.2 (LS_oI protection)

DB438166.ai

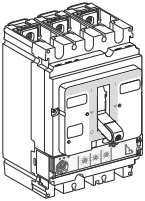

ComPacT NSX100F (36 kA at 380/415 V)

Rating	3P 3d	4P 3d, 4d, 3d + N/2
40	C10F32D040	C10F42D040
100	C10F32D100	C10F42D100

ComPacT NSX160F (36 kA at 380/415 V)

Rating	3P 3d	4P 3d, 4d, 3d + N/2
100	C16F32D100	C16F42D100
160	C16F32D160	C16F42D160

ComPacT NSX250F (36 kA at 380/415 V)

Rating	3P 3d	4P 3d, 4d, 3d + N/2
100	C25F32D100	C25F42D100
160	C25F32D160	C25F42D160
250	C25F32D250	C25F42D250

With electronic trip unit MicroLogic Vigi 4.2 (LS_oIR protection)

DB438167.ai

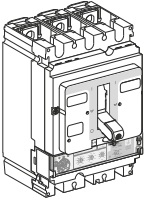

ComPacT NSX100F (36 kA 380/415V)

Rating	3P 3d	4P 4d, 3d + N/2
40 A	C10F34V040	C10F44V040
100 A	C10F34V100	C10F44V100

ComPacT NSX160F (36 kA 380/415V)

Rating	3P 3d	4P 4d, 3d + N/2
100 A	C16F34V100	C16F44V100
160 A	C16F34V160	C16F44V160

ComPacT NSX250F (36 kA 380/415V)

Rating	3P 3d	4P 4d, 3d + N/2
100 A	C25F34V100	C25F44V100
160 A	C25F34V160	C25F44V160
250 A	C25F34V250	C25F44V250

With electronic trip unit MicroLogic Vigi 7.2 E (LSIR protection + embedded energy management)

DB438657.ai

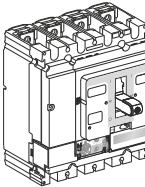

ComPacT NSX100F (36 kA 380/415V)

Rating	3P 3d	4P 4d, 3d + N/2
40 A	-	C10F47E040
100 A	-	C10F47E100

ComPacT NSX160F (36 kA 380/415V)

Rating	3P 3d	4P 4d, 3d + N/2
100 A	-	C16F47E100
160 A	-	C16F47E160

ComPacT NSX250F (36 kA 380/415V)

Rating	3P 3d	4P 4d, 3d + N/2
100 A	-	C25F47E100
160 A	-	C25F47E160
250 A	-	C25F47E250

With electronic trip unit MicroLogic 5.2 E (LSI protection, energy meter)

Only available as separate component or through online configurator (product selector)

With electronic trip unit MicroLogic 6.2 E (LSIG protection, energy meter)

Only available as separate component or through online configurator (product selector)

With electronic trip unit MicroLogic 7.2 E (LSIG protection, energy meter)

Only available as separate component or through online configurator (product selector)

Complete Fixed Device

ComPacT NSX100/160/250F (36 kA 380/415 V)

ComPacT NSX100/160/250F

With magnetic trip unit MA

DE-439168.ai

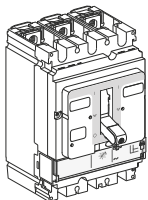

ComPacT NSX100F (36 kA at 380/415 V)

Rating	3P 3d
MA2.5	C10F3MA003
MA6.3	C10F3MA007
MA12.5	C10F3MA013
MA25	C10F3MA025
MA50	C10F3MA050
MA100	C10F3MA100

ComPacT NSX160F (36 kA at 380/415 V)

Rating	3P 3d
MA100	C16F3MA100
MA150	C16F3MA150

ComPacT NSX250F (36 kA at 380/415 V)

Rating	3P 3d
MA150	C25F3MA150
MA220	C25F3MA220

With electronic trip unit MicroLogic 6.2 E-M (LSIG motor protection, energy meter)

Only available as separate component or through online configurator (product selector)



Complete Fixed Device

ComPacT NSX100/160/250N (50 KA 380/415 V)

ComPacT NSX100/160/250N

With thermal-magnetic trip unit TM-D

DB-38165.ai

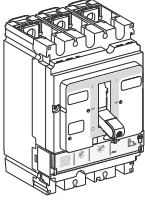

ComPacT NSX100N (50 kA at 380/415 V)

Rating	3P 3d	4P 3d	4P 4d
TM16D	C10N3TM016	C10N6TM016	C10N4TM016
TM25D	C10N3TM025	C10N6TM025	C10N4TM025
TM32D	C10N3TM032	C10N6TM032	C10N4TM032
TM40D	C10N3TM040	C10N6TM040	C10N4TM040
TM50D	C10N3TM050	C10N6TM050	C10N4TM050
TM63D	C10N3TM063	C10N6TM063	C10N4TM063
TM80D	C10N3TM080	C10N6TM080	C10N4TM080
TM100D	C10N3TM100	C10N6TM100	C10N4TM100

ComPacT NSX160N (50 kA at 380/415 V)

Rating	3P 3d	4P 3d	4P 4d
TM80D	C16N3TM080	C16N6TM080	C16N4TM080
TM100D	C16N3TM100	C16N6TM100	C16N4TM100
TM125D	C16N3TM125	C16N6TM125	C16N4TM125
TM160D	C16N3TM160	C16N6TM160	C16N4TM160

ComPacT NSX250N (50 kA at 380/415 V)

Rating	3P 3d	4P 3d	4P 4d
TM125D	C25N3TM125	C25N6TM125	C25N4TM125
TM160D	C25N3TM160	C25N6TM160	C25N4TM160
TM200D	C25N3TM200	C25N6TM200	C25N4TM200
TM250D	C25N3TM250	C25N6TM250	C25N4TM250

With electronic trip unit MicroLogic 2.2 (LS_oI protection)

DB-38166.ai

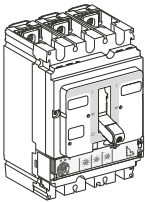

ComPacT NSX100N (50 kA at 380/415 V)

Rating	3P 3d	4P 3d, 4d, 3d + N/2
40 A	C10N32D040	C10N42D040
100 A	C10N32D100	C10N42D100

ComPacT NSX160N (50 kA at 380/415 V)

Rating	3P 3d	4P 3d, 4d, 3d + N/2
100 A	C16N32D100	C16N42D100
160 A	C16N32D160	C16N42D160

ComPacT NSX250N (50 kA at 380/415 V)

Rating	3P 3d	4P 3d, 4d, 3d + N/2
100 A	C25N32D100	C25N42D100
160 A	C25N32D160	C25N42D160
250 A	C25N32D250	C25N42D250

With electronic trip unit MicroLogic Vigi 4.2 (LS_oIR protection)

DB-38167.ai

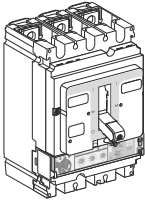

ComPacT NSX100N (50 kA 380/415V)

Rating	3P 3d	4P 4d, 3d + N/2
40 A	C10N34V040	C10N44V040
100 A	C10N34V100	C10N44V100

ComPacT NSX160N (50 kA 380/415V)

Rating	3P 3d	4P 4d, 3d + N/2
100 A	C16N34V100	C16N44V100
160 A	C16N34V160	C16N44V160

ComPacT NSX250N (50 kA 380/415V)

Rating	3P 3d	4P 4d, 3d + N/2
100 A	C25N34V100	C25N44V100
160 A	C25N34V160	C25N44V160
250 A	C25N34V250	C25N44V250

With electronic trip unit MicroLogic Vigi 7.2 E (LSIR protection + embedded energy management)

DB-38567.ai

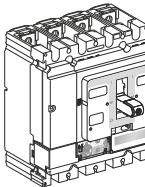

ComPacT NSX100N (50 kA 380/415V)

Rating	3P 3d	4P 4d, 3d + N/2
40 A	-	C10N47E040
100 A	-	C10N47E100

ComPacT NSX160N (50 kA 380/415V)

Rating	3P 3d	4P 4d, 3d + N/2
100 A	-	C16N47E100
160 A	-	C16N47E160

ComPacT NSX250N (50 kA 380/415V)

Rating	3P 3d	4P 4d, 3d + N/2
100 A	-	C25N47E100
160 A	-	C25N47E160
250 A	-	C25N47E250

With electronic trip unit MicroLogic 5.2 E (LSI protection, energy meter)

Only available as separate component or through online configurator (product selector)

With electronic trip unit MicroLogic 6.2 E (LSIG protection, energy meter)

Only available as separate component or through online configurator (product selector)

With electronic trip unit MicroLogic 7.2 E (LSIG protection, energy meter)

Only available as separate component or through online configurator (product selector)

Complete Fixed Device

ComPacT NSX100/160/250N (50 KA 380/415 V)

ComPacT NSX100/160/250N

With magnetic trip unit MA

DB458168.ai

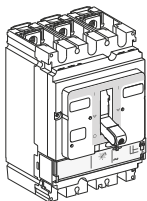

ComPacT NSX100N (50 kA at 380/415 V)

Rating	3P 3d
MA2.5	C10N3MA003
MA6.3	C10N3MA007
MA12.5	C10N3MA013
MA25	C10N3MA025
MA50	C10N3MA050
MA100	C10N3MA100

ComPacT NSX160N (50 kA at 380/415 V)

Rating	3P 3d
MA100	C16N3MA100
MA150	C16N3MA150

ComPacT NSX250N (50 kA at 380/415 V)

Rating	3P 3d
MA150	C25N3MA150
MA220	C25N3MA220

With electronic trip unit MicroLogic 6.2 E-M (LSIG motor protection, energy meter)

Only available as separate component or through online configurator (product selector)



Complete Fixed Device

ComPacT NSX100/160/250H (70 kA 380/415 V)

ComPacT NSX100/160/250H

With thermal-magnetic trip unit TM-D

DB-30165.ai

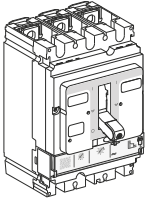

ComPacT NSX100H (70 kA at 380/415 V)

Rating	3P 3d	4P 3d	4P 4d
TM16D	C10H3TM016	C10H6TM016	C10H4TM016
TM25D	C10H3TM025	C10H6TM025	C10H4TM025
TM32D	C10H3TM032	C10H6TM032	C10H4TM032
TM40D	C10H3TM040	C10H6TM040	C10H4TM040
TM50D	C10H3TM050	C10H6TM050	C10H4TM050
TM63D	C10H3TM063	C10H6TM063	C10H4TM063
TM80D	C10H3TM080	C10H6TM080	C10H4TM080
TM100D	C10H3TM100	C10H6TM100	C10H4TM100

ComPacT NSX160H (70 kA at 380/415 V)

Rating	3P 3d	4P 3d	4P 4d
TM80D	C16H3TM080	C16H6TM080	C16H4TM080
TM100D	C16H3TM100	C16H6TM100	C16H4TM100
TM125D	C16H3TM125	C16H6TM125	C16H4TM125
TM160D	C16H3TM160	C16H6TM160	C16H4TM160

ComPacT NSX250H (70 kA at 380/415 V)

Rating	3P 3d	4P 3d	4P 4d
TM125D	C25H3TM125	C25H6TM125	C25H4TM125
TM160D	C25H3TM160	C25H6TM160	C25H4TM160
TM200D	C25H3TM200	C25H6TM200	C25H4TM200
TM250D	C25H3TM250	C25H6TM250	C25H4TM250

With electronic trip unit MicroLogic 2.2 (LS_oI protection)

DB-30166.ai

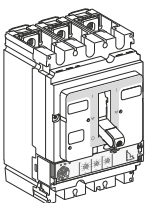

ComPacT NSX100H (70 kA at 380/415 V)

Rating	3P 3d	4P 3d, 4d, 3d + N/2
40 A	C10H32D040	C10H42D040
100 A	C10H32D100	C10H42D100

ComPacT NSX160H (70 kA at 380/415 V)

Rating	3P 3d	4P 3d, 4d, 3d + N/2
100 A	C16H32D100	C16H42D100
160 A	C16H32D160	C16H42D160

ComPacT NSX250H (70 kA at 380/415 V)

Rating	3P 3d	4P 3d, 4d, 3d + N/2
100 A	C25H32D100	C25H42D100
160 A	C25H32D160	C25H42D160
250 A	C25H32D250	C25H42D250

With electronic trip unit MicroLogic Vigi 4.2 (LS_oIR protection)

DB-30167.ai

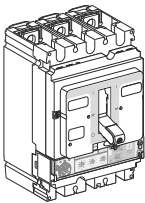

ComPacT NSX100H (70 kA 380/415V)

Rating	3P 3d	4P 4d, 3d + N/2
40 A	C10H34V040	C10H44V040
100 A	C10H34V100	C10H44V100

ComPacT NSX160H (70 kA 380/415V)

Rating	3P 3d	4P 4d, 3d + N/2
100 A	C16H34V100	C16H44V100
160 A	C16H34V160	C16H44V160

ComPacT NSX250H (70 kA 380/415V)

Rating	3P 3d	4P 4d, 3d + N/2
100 A	C25H34V100	C25H44V100
160 A	C25H34V160	C25H44V160
250 A	C25H34V250	C25H44V250

With electronic trip unit MicroLogic Vigi 7.2 E (LSIR protection + embedded energy management)

DB-30168.ai

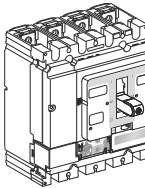

ComPacT NSX100H (70 kA 380/415V)

Rating	3P 3d	4P 4d, 3d + N/2
40 A	-	C10H47E040
100 A	-	C10H47E100

ComPacT NSX160H (70 kA 380/415V)

Rating	3P 3d	4P 4d, 3d + N/2
100 A	-	C16H47E100
160 A	-	C16H47E160

ComPacT NSX250H (70 kA 380/415V)

Rating	3P 3d	4P 4d, 3d + N/2
100 A	-	C25H47E100
160 A	-	C25H47E160
250 A	-	C25H47E250

With electronic trip unit MicroLogic 5.2 E (LSI protection, energy meter)

Only available as separate component or through online configurator (product selector)

With electronic trip unit MicroLogic 6.2 E (LSIG protection, energy meter)

Only available as separate component or through online configurator (product selector)

With electronic trip unit MicroLogic 7.2 E (LSIG protection, energy meter)

Only available as separate component or through online configurator (product selector)

Complete Fixed Device

ComPacT NSX100/160/250H (70 kA 380/415 V)

ComPacT NSX100/160/250H

With magnetic trip unit MA

DB438168.ai

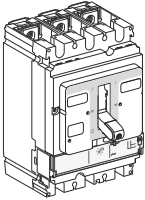

ComPacT NSX100H (70 kA at 380/415 V)

Rating	3P 3d
MA2.5	C10H3MA003
MA6.3	C10H3MA007
MA12.5	C10H3MA013
MA25	C10H3MA025
MA50	C10H3MA050
MA100	C10H3MA100

ComPacT NSX160H (70 kA at 380/415 V)

Rating	3P 3d
MA100	C16H3MA100
MA150	C16H3MA150

ComPacT NSX250H (70 kA at 380/415 V)

Rating	3P 3d
MA150	C25H3MA150
MA220	C25H3MA220

With electronic trip unit MicroLogic 2.2 M (LS_oI motor protection)

DB438166.ai

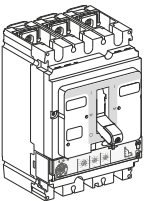

ComPacT NSX100H (70 kA at 380/415 V)

Rating	3P 3d
25 A	C10H32M025
50 A	C10H32M050
100 A	C10H32M100

ComPacT NSX160H (70 kA at 380/415 V)

Rating	3P 3d
100 A	C16H32M100
150 A	C16H32M150

ComPacT NSX250H (70 kA at 380/415 V)

Rating	3P 3d
150 A	C25H32M150
220 A	C25H32M220

With electronic trip unit MicroLogic 6.2 E-M (LSIG motor protection, energy meter)

Only available as separate component or through online configurator (product selector)



Complete Fixed Device

ComPacT NSX100/250R (200 kA 380/415 V - 45 kA 690 V)

ComPacT NSX100/250R

With thermal-magnetic trip unit TM-D

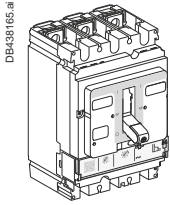

ComPacT NSX100R (200 kA at 380/415 V - 45 kA at 690 V)

Rating	3P 3d	4P 4d
TM40D	C10R3TM040	C10R4TM040
TM50D	C10R3TM050	C10R4TM050
TM63D	C10R3TM063	C10R4TM063
TM80D	C10R3TM080	C10R4TM080
TM100D	C10R3TM100	C10R4TM100

ComPacT NSX250R (200 kA at 380/415 V - 45 kA at 690 V)

Rating	3P 3d	4P 4d
TM125D	C25R3TM125	C25R4TM125
TM160D	C25R3TM160	C25R4TM160
TM200D	C25R3TM200	C25R4TM200
TM250D	C25R3TM250	C25R4TM250

With electronic trip unit MicroLogic 2.2 (LS_oI protection)

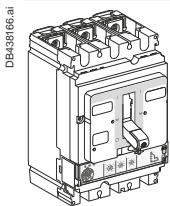

ComPacT NSX100R (200 kA at 380/415 V - 45 kA at 690 V)

Rating	3P 3d	4P 3d, 4d, 3d + N/2
40 A	C10R32D040	C10R42D040
100 A	C10R32D100	C10R42D100

ComPacT NSX250R (200 kA at 380/415 V - 45 kA at 690 V)

Rating	3P 3d	4P 3d, 4d, 3d + N/2
100 A	C25R32D100	C25R42D100
160 A	C25R32D160	C25R42D160
250 A	C25R32D250	C25R42D250

With electronic trip unit MicroLogic 5.2 E (LSI protection, energy meter)

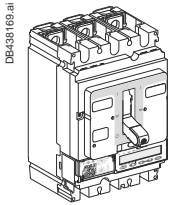

ComPacT NSX100R (200 kA at 380/415 V - 45 kA at 690 V)

Rating	3P 3d	4P 3d, 4d, 3d + N/2, OSN
40 A	C10R35E040	C10R45E040
100 A	C10R35E100	C10R45E100

ComPacT NSX250R (200 kA at 380/415 V - 45 kA at 690 V)

Rating	3P 3d	4P 3d, 4d, 3d + N/2, OSN
100 A	C25R35E100	C25R45E100
160 A	C25R35E160	C25R45E160
250 A	C25R35E250	C25R45E250

With electronic trip unit MicroLogic 6.2 E (LSIG protection, energy meter)

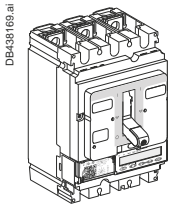

ComPacT NSX100R (200 kA at 380/415 V - 45 kA at 690 V)

Rating	3P 3d	4P 3d, 4d, 3d + N/2, OSN
40 A	C10R36E040	C10R46E040
100 A	C10R36E100	C10R46E100

ComPacT NSX250R (200 kA at 380/415 V - 45 kA at 690 V)

Rating	3P 3d	4P 3d, 4d, 3d + N/2, OSN
100 A	C25R36E100	C25R46E100
160 A	C25R36E160	C25R46E160
250 A	C25R36E250	C25R46E250

F

Complete Fixed Device

ComPacT NSX100/250R (200 kA 380/415 V - 45 kA 690 V)

ComPacT NSX100/250R

With magnetic trip unit MA

DB438168.ai

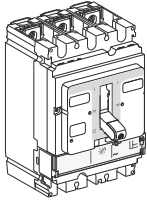

ComPacT NSX100R (200 kA at 380/415 V - 45 kA at 690 V)

Rating	3P 3d
MA12.5	C10R3MA013
MA25	C10R3MA025
MA50	C10R3MA050
MA100	C10R3MA100

ComPacT NSX250R (200 kA at 380/415 V - 45 kA at 690 V)

Rating	3P 3d
MA150	C25R3MA150
MA220	C25R3MA220

With electronic trip unit MicroLogic 2.2 M (LS_oI motor protection)

DB438169.ai

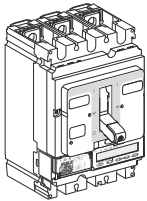

ComPacT NSX100R (200 kA at 380/415 V - 45 kA at 690 V)

Rating	3P 3d
25 A	C10R32M025
50 A	C10R32M050
100 A	C10R32M100

ComPacT NSX250R (200 kA at 380/415 V - 45 kA at 690 V)

Rating	3P 3d
150 A	C25R32M150
220 A	C25R32M220

With electronic trip unit MicroLogic 6.2 E-M (LSIG motor protection, energy meter)

DB438169.ai

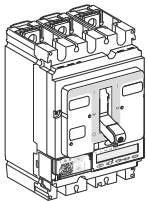

ComPacT NSX100R (200 kA at 380/415 V - 45 kA at 690 V)

Rating	3P 3d
25 A	C10R36M025
50 A	C10R36M050
80 A	C10R36M080

ComPacT NSX250R (200 kA at 380/415 V - 45 kA at 690 V)

Rating	3P 3d
150 A	C25R36M150
220 A	C25R36M220



Complete Fixed Device

ComPacT NSX100/250HB1 (85 KA 500 V - 75 KA 690 V)

ComPacT NSX100/250HB1

With thermal-magnetic trip unit TM-D

DB438168.ai

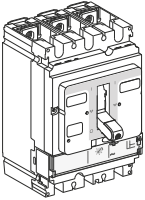

ComPacT NSX100HB1 (85 kA at 500 V - 75 kA at 690 V)

Rating	3P 3d	4P 4d
TM40D	C10V3TM040	C10V4TM040
TM50D	C10V3TM050	C10V4TM050
TM63D	C10V3TM063	C10V4TM063
TM80D	C10V3TM080	C10V4TM080
TM100D	C10V3TM100	C10V4TM100

ComPacT NSX250HB1 (85 kA at 500 V - 75 kA at 690 V)

Rating	3P 3d	4P 4d
TM125D	C25V3TM125	C25V4TM125
TM160D	C25V3TM160	C25V4TM160
TM200D	C25V3TM200	C25V4TM200
TM250D	C25V3TM250	C25V4TM250

With electronic trip unit MicroLogic 2.2 (LS_oI protection)

DB438166.ai

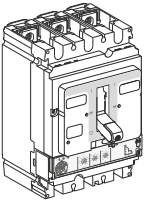

ComPacT NSX100HB1 (85 kA at 500 V - 75 kA at 690 V)

Rating	3P 3d	4P 3d, 4d, 3d + N/2
40 A	C10V32D040	C10V42D040
100 A	C10V32D100	C10V42D100

ComPacT NSX250HB1 (85 kA at 500 V - 75 kA at 690 V)

Rating	3P 3d	4P 3d, 4d, 3d + N/2
100 A	C25V32D100	C25V42D100
160 A	C25V32D160	C25V42D160
250 A	C25V32D250	C25V42D250

With electronic trip unit MicroLogic 5.2 E (LSI protection, energy meter)

DB438167.ai

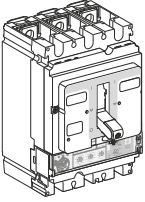

ComPacT NSX100HB1 (85 kA at 500 V - 75 kA at 690 V)

Rating	3P 3d	4P 3d, 4d, 3d + N/2, OSN
40 A	C10V35E040	C10V45E040
100 A	C10V35E100	C10V45E100

ComPacT NSX250HB1 (85 kA at 500 V - 75 kA at 690 V)

Rating	3P 3d	4P 3d, 4d, 3d + N/2, OSN
100 A	C25V35E100	C25V45E100
160 A	C25V35E160	C25V45E160
250 A	C25V35E250	C25V45E250

With electronic trip unit MicroLogic 6.2 E (LSIG protection, energy meter)

DB438169.ai

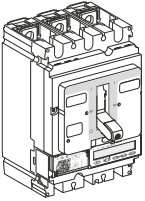

ComPacT NSX100HB1 (85 kA at 500 V - 75 kA at 690 V)

Rating	3P 3d	4P 3d, 4d, 3d + N/2, OSN
40 A	C10V36E040	C10V46E040
100 A	C10V36E100	C10V46E100

ComPacT NSX250HB1 (85 kA at 500 V - 75 kA at 690 V)

Rating	3P 3d	4P 3d, 4d, 3d + N/2, OSN
100 A	C25V36E100	C25V46E100
160 A	C25V36E160	C25V46E160
250 A	C25V36E250	C25V46E250

Complete Fixed Device

ComPacT NSX100/250HB1 (85 KA 500 V - 75 KA 690 V)

ComPacT NSX100/250HB1

With magnetic trip unit MA

DB438168.ai

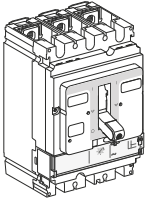

ComPacT NSX100HB1 (85 kA at 500 V - 75 kA at 690 V)

Rating	3P 3d
MA12.5	C10V3MA013
MA25	C10V3MA025
MA50	C10V3MA050
MA100	C10V3MA100

ComPacT NSX250HB1 (85 kA at 500 V - 75 kA at 690 V)

Rating	3P 3d
MA150	C25V3MA150
MA220	C25V3MA220

With electronic trip unit MicroLogic 2.2 M (LS_oI motor protection)

DB438166.ai

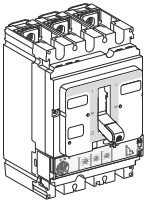

ComPacT NSX100HB1 (85 kA at 500 V - 75 kA at 690 V)

Rating	3P 3d
25 A	C10V32M025
50 A	C10V32M050
100 A	C10V32M100

ComPacT NSX250HB1 (85 kA at 500 V - 75 kA at 690 V)

Rating	3P 3d
150 A	C25V32M150
220 A	C25V32M220

With electronic trip unit MicroLogic 6.2 E-M (LSIG motor protection, energy meter)

DB438169.ai

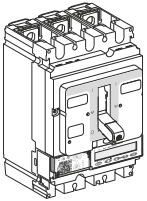

ComPacT NSX100HB1 (85 kA at 500 V - 75 kA at 690 V)

Rating	3P 3d
25 A	C10V36M025
50 A	C10V36M050
80 A	C10V36M080

ComPacT NSX250HB1 (85 kA at 500 V - 75 kA at 690 V)

Rating	3P 3d
150 A	C25V36M150
220 A	C25V36M220

Complete Fixed Device

ComPacT NSX100/250HB2 (100 kA 500 V - 100 kA 690 V)

ComPacT NSX100/250HB2

With thermal-magnetic trip unit TM-D

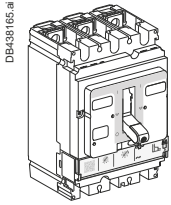

ComPacT NSX100HB2 (100 kA at 500 V - 100 kA at 690 V)

Rating	3P 3d	4P 4d
TM63D	C10W3TM063	C10W4TM063
TM80D	C10W3TM080	C10W4TM080
TM100D	C10W3TM100	C10W4TM100

ComPacT NSX250HB2 (100 kA at 500 V - 100 kA at 690 V)

Rating	3P 3d	4P 4d
TM125D	C25W3TM125	C25W4TM125
TM160D	C25W3TM160	C25W4TM160
TM200D	C25W3TM200	C25W4TM200
TM250D	C25W3TM250	C25W4TM250

With electronic trip unit MicroLogic 2.2 (LS_oI protection)

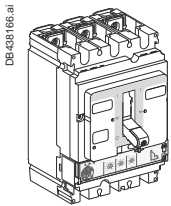

ComPacT NSX100HB2 (100 kA at 500 V - 100 kA at 690 V)

Rating	3P 3d	4P 3d, 4d, 3d + N/2
40 A	C10W32D040	C10W42D040
100 A	C10W32D100	C10W42D100

ComPacT NSX250HB2 (100 kA at 500 V - 100 kA at 690 V)

Rating	3P 3d	4P 3d, 4d, 3d + N/2
100 A	C25W32D100	C25W42D100
160 A	C25W32D160	C25W42D160
250 A	C25W32D250	C25W42D250

With electronic trip unit MicroLogic 5.2 E (LSI protection, energy meter)

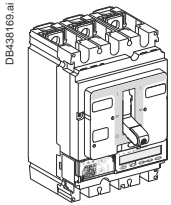

ComPacT NSX100HB2 (100 kA at 500 V - 100 kA at 690 V)

Rating	3P 3d	4P 3d, 4d, 3d + N/2, OSN
40 A	C10W35E040	C10W45E040
100 A	C10W35E100	C10W45E100

ComPacT NSX250HB2 (100 kA at 500 V - 100 kA at 690 V)

Rating	3P 3d	4P 3d, 4d, 3d + N/2, OSN
100 A	C25W35E100	C25W45E100
160 A	C25W35E160	C25W45E160
250 A	C25W35E250	C25W45E250

With electronic trip unit MicroLogic 6.2 E (LSIG protection, energy meter)

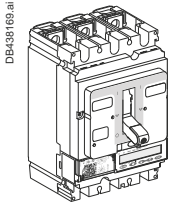

ComPacT NSX100HB2 (100 kA at 500 V - 100 kA at 690 V)

Rating	3P 3d	4P 3d, 4d, 3d + N/2, OSN
40 A	C10W36E040	C10W46E040
100 A	C10W36E100	C10W46E100

ComPacT NSX250HB2 (100 kA at 500 V - 100 kA at 690 V)

Rating	3P 3d	4P 3d, 4d, 3d + N/2, OSN
100 A	C25W36E100	C25W46E100
160 A	C25W36E160	C25W46E160
250 A	C25W36E250	C25W46E250

Complete Fixed Device

ComPacT NSX100/250HB2 (100 kA 500 V - 100 kA 690 V)

ComPacT NSX100/250HB2

With magnetic trip unit MA

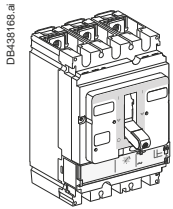

ComPacT NSX100HB2 (100 kA at 500 V - 100 kA at 690 V)

Rating	3P 3d
MA12.5	C10W3MA013
MA25	C10W3MA025
MA50	C10W3MA050
MA100	C10W3MA100

ComPacT NSX250HB2 (100 kA at 500 V - 100 kA at 690 V)

Rating	3P 3d
MA150	C25W3MA150
MA220	C25W3MA220

With electronic trip unit MicroLogic 2.2 M (LS_oI motor protection)

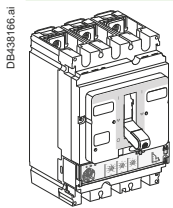

ComPacT NSX100HB2 (100 kA at 500 V - 100 kA at 690 V)

Rating	3P 3d
25 A	C10W32M025
50 A	C10W32M050
100 A	C10W32M100

ComPacT NSX250HB2 (100 kA at 500 V - 100 kA at 690 V)

Rating	3P 3d
150 A	C25W32M150
220 A	C25W32M220

With electronic trip unit MicroLogic 6.2 E-M (LSIG motor protection, energy meter)

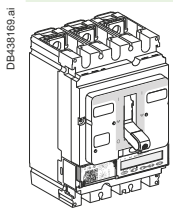

ComPacT NSX100HB2 (100 kA at 500 V - 100 kA at 690 V)

Rating	3P 3d
25 A	C10W36M025
50 A	C10W36M050
80 A	C10W36M080

ComPacT NSX250HB2 (100 kA at 500 V - 100 kA at 690 V)

Rating	3P 3d
150 A	C25W36M150
220 A	C25W36M220



Catalog Numbers

Complete Fixed Device ComPacT NSX100/160/250NA

ComPacT NSX100/160/250NA Switch-Disconnecter

With NA switch-disconnector unit

DE438770.ai

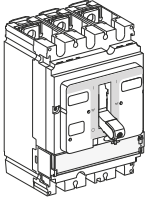

ComPacT NSX100NA		
Rating	3P	4P
100 A	C103100S	C104100S
ComPacT NSX160NA		
Rating	3P	4P
160 A	C163160S	C164160S
ComPacT NSX250NA		
Rating	3P	4P
250 A	C253250S	C254250S



Based on Separate Components

ComPacT NSX100/160/250

Basic Frame

DB45871.ai

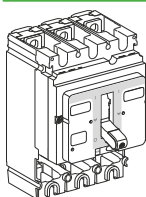

ComPacT NSX100

	3P	4P
NSX100B (25 kA 380/415 V)	C10B3	C10B4
NSX100F (36 kA 380/415 V)	C10F3	C10F4
NSX100N (50 kA 380/415 V)	C10N3	C10N4
NSX100H (70 kA 380/415 V)	C10H3	C10H4
NSX100S (100 kA 380/415 V)	C10S3	C10S4
NSX100L (150 kA 380/415 V)	C10L3	C10L4

ComPacT NSX160

	3P	4P
NSX160B (25 kA 380/415 V)	C16B3	C16B4
NSX160F (36 kA 380/415 V)	C16F3	C16F4
NSX160N (50 kA 380/415 V)	C16N3	C16N4
NSX160H (70 kA 380/415 V)	C16H3	C16H4
NSX160S (100 kA 380/415 V)	C16S3	C16S4
NSX160L (150 kA 380/415 V)	C16L3	C16L4

ComPacT NSX250

	3P	4P
NSX250B (25 kA 380/415 V)	C25B3	C25B4
NSX250F (36 kA 380/415 V)	C25F3	C25F4
NSX250N (50 kA 380/415 V)	C25N3	C25N4
NSX250H (70 kA 380/415 V)	C25H3	C25H4
NSX250S (100 kA 380/415 V)	C25S3	C25S4
NSX250L (150 kA 380/415 V)	C25L3	C25L4

+ Trip Unit

Distribution protection

DB112246.eps

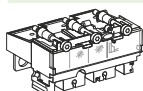

Thermal-magnetic TM-D

Rating	3P 3d	4P 3d	4P 4d
TM16D	C103TM016	C106TM016	C104TM016
TM25D	C103TM025	C106TM025	C104TM025
TM32D	C103TM032	C106TM032	C104TM032
TM40D	C103TM040	C106TM040	C104TM040
TM50D	C103TM050	C106TM050	C104TM050
TM63D	C103TM063	C106TM063	C104TM063
TM80D	C103TM080	C106TM080	C104TM080
TM100D	C103TM100	C106TM100	C104TM100
TM125D	C163TM125	C166TM125	C164TM125
TM160D ^[1]	C163TM160	C166TM160	C164TM160
TM160D ^[2]	C253TM160	C256TM160	C254TM160
TM200D	C253TM200	C256TM200	C254TM200
TM250D	C253TM250	C256TM250	C254TM250

MicroLogic 2.2 (LS₀I protection)

Rating	3P 3d	4P 3d, 4d, 3d + N/2
40 A	C1032D040	C1042D040
100 A	C1032D100	C1042D100
160 A	C1632D160	C1642D160
250 A	C2532D250	C2542D250

MicroLogic 5.2 E (LSI protection, energy meter)

Rating	3P 3d	4P 3d, 4d, 3d + N/2, 3d + OSN
40 A	C1035E040	C1045E040
100 A	C1035E100	C1045E100
160 A	C1635E160	C1645E160
250 A	C2535E250	C2545E250

MicroLogic 6.2 E (LSIG protection, energy meter)

Rating	3P 3d	4P 3d, 4d, 3d + N/2, 3d + OSN
40 A	C1036E040	C1046E040
100 A	C1036E100	C1046E100
160 A	C1636E160	C1646E160
250 A	C2536E250	C2546E250

[1] For NSX160.

[2] For NSX250.

DB112247.eps

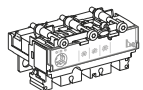

DB112248.eps

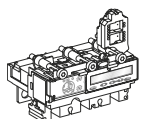

F

Based on Separate Components

ComPacT NSX100/160/250

+ Trip Unit (Cont.)

Distribution protection with embedded earth leakage protection

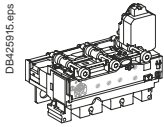

MicroLogic Vigi 4.2 (LS_oIR protection)

Rating	3P 3d	4P 4d 3d + N/2
40 A	C1034V040	C1044V040
100 A	C1034V100	C1044V100
160 A	C1634V160	C1644V160
250 A	C2534V250	C2544V250

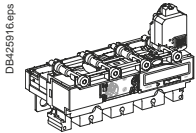

MicroLogic Vigi 7.2 E (LSIR protection)

Rating	3P 3d	4P 4d 3d + N/2
40 A	-	C1047E040
100 A	-	C1047E100
160 A	-	C1647E160
250 A	-	C2547E250

Distribution protection with embedded earth leakage alarm

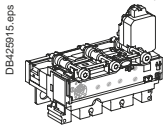

MicroLogic Vigi 4.2 AL (LS_oI protection + earth leakage alarm)

Rating	3P 3d	4P 4d 3d + N/2
40 A	C1034A040	C1044A040
100 A	C1034A100	C1044A100
160 A	C1634A160	C1644A160
250 A	C2534A250	C2544A250

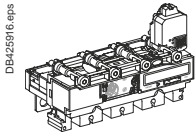

MicroLogic Vigi 7.2 E AL (LSI protection + earth leakage alarm)

Rating	3P 3d	4P 4d 3d + N/2
40 A	-	C1047A040
100 A	-	C1047A100
160 A	-	C1647A160
250 A	-	C2547A250

Motor protection

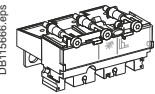

Magnetic MA (I protection)

Rating	3P 3d	4P 3d
MA2.5	C103MA003	
MA6.3	C103MA007	
MA12.5	C103MA013	
MA25	C103MA025	
MA50	C103MA050	
MA100	C103MA100	C106MA100
MA150	C163MA150	C166MA150
MA220	C253MA220	C256MA220

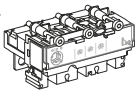

MicroLogic 2.2 M (LS_oI protection)

Rating	3P 3d
25 A	C1032M025
50 A	C1032M050
100 A	C1032M100
150 A	C1632M150
220 A	C2532M220

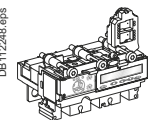

MicroLogic 6.2 E-M (LSIG protection, energy meter)

Rating	3P 3d
25 A	C1036M025
50 A	C1036M050
80 A	C1036M080
150 A	C1636M150
220 A	C2536M220

Generator protection

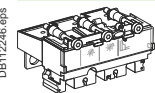

Thermal-magnetic TM-G

Rating	3P 3d	4P 4d
TM16G	C103MG016	C104MG016
TM25G	C103MG025	C104MG025
TM40G	C103MG040	C104MG040
TM63G	C103MG063	C104MG063
TM80G	C103MG080	C104MG080
TM100G	C103MG100	C104MG100
TM125G	C163MG125	C164MG125
TM160G	C163MG160	C164MG160
TM200G	C253MG200	C254MG200
TM250G	C253MG250	C254MG250

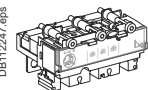

MicroLogic 2.2 G (LS_oI protection)

Rating	3P 3d	4P 3d, 4d, 3d + N/2
40 A	C1032G040	C1042G040
100 A	C1032G100	C1042G100
160 A	C1632G160	C1642G160
250 A	C2532G250	C2542G250

F

Based on Separate Components

ComPacT NSX100/160/250

+ Trip Unit (Cont.)

Protection of public distribution systems

DB112247.eps

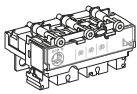

MicroLogic 2.2 AB (LS₀I protection)

Rating	4P 3d, 4d, 3d + N/2
100 A	C1042B100
160 A	C1642B160
240 A	C2542B240

Earth Leakage protection of public distribution systems

MicroLogic Vigi 4.2 AB distribution protections

Rating	4P 3d, 4d, 3d + N/2
100 A	C1044B100
160 A	C1644B160
250 A	C2544B250

16 Hz 2/3 network protection

DB112248.eps

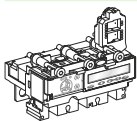

MicroLogic 5.2 A-Z (LSI protection)

Rating	3P 3d
100 A	C1035Z100
250 A	C2535Z250

+ VigiPacT add-on Protection and Alarm Modules

VigiPacT add-on protection

DB112249.eps

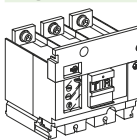

	3P	4P
NSX100/160 (200 to 440 V)	LV429488	LV429489
NSX250 (200 to 440 V)	LV429492	LV429493
NSX100/160 (440 to 550 V)	LV429490	LV429491
NSX250 (440 to 550 V)	LV429494	LV429495
Connection for a 4P VigiPacT on a 3P breaker		LV429214

VigiPacT add-on alarm

DB112246.eps

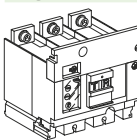



	3P	4P
200 to 440 V AC	LV429498	LV429499
Connection for a 4P insulation monitoring module on a 3P breaker		LV429214

Trip Unit Accessories

ComPacT NSX100/160/250

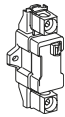
Trip Unit Accessories

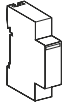
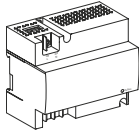
External neutral CT for 3 pole breaker with MicroLogic 5/6			
 DB112733.eps	25-100 A		LV429521
	150-250 A		LV430563
24 V DC wiring accessory for MicroLogic 5/6			
 DB112730.eps	24 V DC power supply connector		LV434210
ZSI wiring accessory for NS630b NW with NSX			
 DB115665.eps	ZSI module		LV434212
External power supply module (24 V DC - 1 A), class 4			
 DB432608.eps	24-30 V DC		LV454440
	48-60 V DC		LV454441
	100-125 V DC		LV454442
	110-130 V AC		LV454443
	200-240 V AC		LV454444

Installation and Connection

ComPacT NSX100/160/250

Fixed/RC Device = Fixed/FC Device + Rear Connection Kit

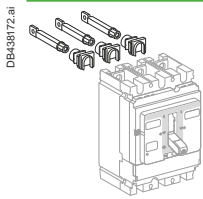

Short RC kit			
Kit 3P		3 x	LV429235
Kit 4P		4 x	LV429235
Mixed RC kit			
Kit 3P	Short RCs	2 x	LV429235
	Long RCs	1 x	LV429236
Kit 4P	Short RCs	2 x	LV429235
	Long RCs	2 x	LV429236

Plug-in Version = Fixed/FC Device + Plug-in Kit

Kit for ComPacT NSX

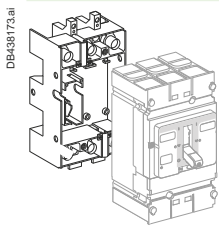

Plug-in kit	3P	4P
Comprising:	LV429289	LV429290
Base	= 1 x LV429266	= 1 x LV429267
Power connections	+ 3 x LV429268	+ 4 x LV429268
Short terminal shields	+ 2 x LV429515	+ 2 x LV429516
Safety trip interlock	+ 1 x LV429270	+ 1 x LV429270

Withdrawable Version = Fixed/FC Device + Withdrawable Kit

Kit for ComPacT NSX

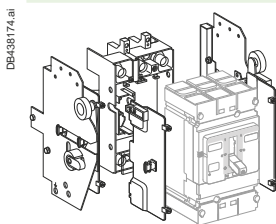





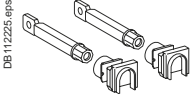
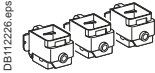
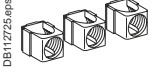
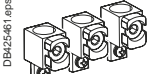
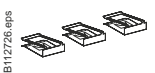
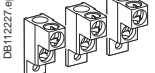
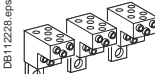

	3P	4P
	Kit for ComPacT NSX	Kit for ComPacT NSX
	=	=
Plug-in kit	1 x LV429289	1 x LV429290
	+	+
Chassis side plates for base	1 x LV429282	1 x LV429282
	+	+
Chassis side plates for breaker	1 x LV429283	1 x LV429283

Accessories and Auxiliaries

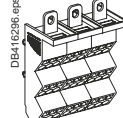
ComPacT NSX100/160/250

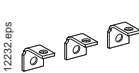
Connection Accessories (Cu or Al)

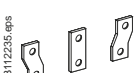
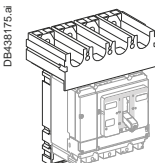
Rear connections				
	2 short			LV429235
	2 long			LV429236
Bare cable connectors				
	Steel connectors	1 x (1.5 to 95 mm ²) ; ≤ 160 A	Set of 2	LV429246
			Set of 3	LV429242
			Set of 4	LV429243
	Aluminium connectors	1 x (25 to 95 mm ²) ; ≤ 250 A	Set of 2	LV429255
			Set of 3	LV429227
			Set of 4	LV429228
		1 x (120 to 185 mm ²) ; ≤ 250 A	Set of 2	LV429247
			Set of 3	LV429259
			Set of 4	LV429260
		1 x (120 to 240 mm ²) ; ≤ 250 A	Set of 3	LV429244
	Clips for connectors		Set of 4	LV429245
			Set of 10	LV429241
	Aluminium connectors for 2 cables ^[1]	2 x (50 to 120 mm ²) ; ≤ 250 A	Set of 3	LV429218
			Set of 4	LV429219
	Aluminium connectors ^[1] for 6 cables	6 x (1.5 to 35 mm ²) ; ≤ 250 A	Set of 3	LV429248
			Set of 4	LV429249
	6.35 mm voltage tap for aluminium connectors for 1 or 2 cables		Set of 10	LV429348
Linergy DX and Linergy DP distribution block (for bare cable)				
	160 A (40 °C) 6 cables S ≤ 10 mm ²		1P	04031
	250 A (40 °C) 9 cables S ≤ 10 mm ²		3P	04033
			4P	04034
Terminal extensions				
	45° terminal extension ^[1]		Set of 3	LV429223
			Set of 4	LV429224
	Edgewise terminal extensions ^[1]		Set of 3	LV429308
			Set of 4	LV429309
	Right-angle terminal extensions ^[1]		Set of 3	LV429261
			Set of 4	LV429262
	Straight terminal extensions ^[1]		Set of 3	LV429263
			Set of 4	LV429264
	Double-L terminal extensions ^[1]		Set of 3	LV429221
			Set of 4	LV429222
	Spreaders from 35 to 45 mm pitch ^[1]		3P	LV431563
			4P	LV431564
	One-piece spreader from 35 to 45 mm pitch		3P	LV431060
			4P	LV431061

[1] Supplied with 2 or 3 interphase barriers.

Accessories and Auxiliaries

ComPacT NSX100/160/250

Crimp lugs for copper cable^[1]

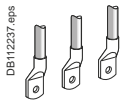

For cable 120 mm ²	Set of 3	LV429252
	Set of 4	LV429256
For cable 150 mm ²	Set of 3	LV429253
	Set of 4	LV429257
For cable 185 mm ²	Set of 3	LV429254
	Set of 4	LV429258

Crimp lugs for aluminium cable^[1]

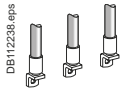

For cable 150 mm ²	Set of 3	LV429504
	Set of 4	LV429505
For cable 185 mm ²	Set of 3	LV429506
	Set of 4	LV429507

Insulation accessories

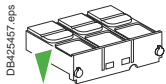

1 short terminal shield for breaker or plug-in base	3P	LV429515
	4P	LV429516

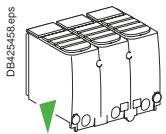

1 long terminal shield for breaker or plug-in base	3P	LV429517
	4P	LV429518

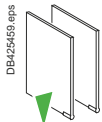

Interphase barriers for breaker or plug-in base	Set of 6	LV429329
---	----------	----------

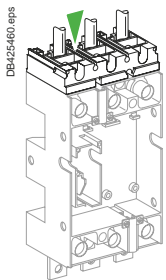

Connection adapter for plug-in base	3P	LV429306
	4P	LV429307

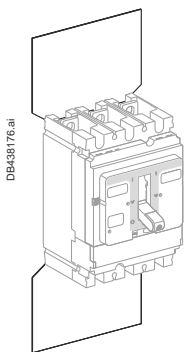

2 insulating screens for breaker (45 mm pitch)	3P	LV429330
	4P	LV429331

[1] Supplied with 2 or 3 interphase barriers.



Accessories and Auxiliaries

ComPacT NSX100/160/250

Electrical Auxiliaries

Auxiliary contacts (wired, screwless)

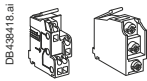

OF or SD or SDE or SDV screwless type	29450
OF or SD or SDE or SDV low level screw type	29452
SDE adapter, mandatory for trip unit TM, MA or MicroLogic 2	LV429451

Auxiliary contacts (wireless)



OF or SD or SDE wireless	LV429454
--------------------------	-----------------

SDx output module for MicroLogic

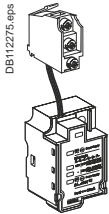

SDx module 24/415 V AC/DC screw type	LV429532
--------------------------------------	-----------------

SDTAM contactor tripping module (early-break thermal fault signal) for MicroLogic 2.2 M/6.2 E-M

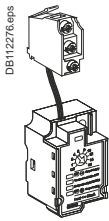

SDTAM 24/415 V AC/DC overload fault indication	LV429424
--	-----------------

Voltage releases

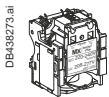

	Voltage	MX	MN
AC	24 V 50/60 Hz	LV429384	LV429404
	48 V 50/60 Hz	LV429385	LV429405
	110-130 V 50/60 Hz	LV429386	LV429406
	220-240 V 50/60 Hz and 208-277 V 60 Hz	LV429387	LV429407
	380-415 V 50 Hz and 440-480 V 60 Hz	LV429388	LV429408
	525 V 50 Hz and 600 V 60 Hz	LV429389	LV429409
DC	12 V	LV429382	LV429402
	24 V	LV429390	LV429410
	30 V	LV429391	LV429411
	48 V	LV429392	LV429412
	60 V	LV429383	LV429403
	125 V	LV429393	LV429413
	250 V	LV429394	LV429414

MN 48 V 50/60 Hz with fixed time delay

Composed of:	MN 48 V DC	LV429412
	Delay unit 48 V 50/60 Hz	LV429426

MN 220-240 V 50/60 Hz with fixed time delay

Composed of:	MN 250 V DC	LV429414
	Delay unit 220-240 V 50/60 Hz	LV429427

MN 48 V DC/AC 50/60 Hz with adjustable time delay

Composed of:	MN 48 V DC	LV429412
	Delay unit 48 V DC/AC 50/60 Hz	33680

MN 110-130 V DC/AC 50/60 Hz with adjustable time delay

Composed of:	MN 125 V DC	LV429413
	Delay unit 100-130 V DC/AC 50/60 Hz	33681

MN 220-250 V DC/AC 50/60 Hz with adjustable time delay

Composed of:	MN 250 V DC	LV429414
	Delay unit 200-250 V DC/AC 50-60 Hz	33682

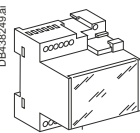



F

Motor Mechanism

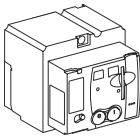
Motor mechanism module supplied with SDE adapter

		Voltage	MT100/160	MT250
	AC	48-60 V 50/60 Hz	LV429440	LV431548
		110-130 V 50/60 Hz	LV429433	LV431540
		220-240 V 50/60 Hz and 208-277 V 60 Hz	LV429434	LV431541
		380-415 V 50/60 Hz and 440-480 V 60 Hz	LV429435	LV431542
	DC	24-30 V	LV429436	LV431543
		48-60 V	LV429437	LV431544
		110-130 V	LV429438	LV431545
		250 V	LV429439	LV431546

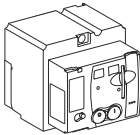
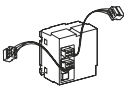
Communicating motor mechanism module supplied with SDE adapter

  	Motor mechanism module	MTc 100/160	220-240 V 50/60 Hz	LV429441	
		MTc 250	220-240 V 50/60 Hz	LV431549	
	+	Breaker and Status Communication Module	BSCM		LV434205
	+	NSX cord	Wire length L = 0.35 m		LV434200
			Wire length L = 1.3 m		LV434201
			Wire length L = 3 m		LV434202
			U > 480 V AC wire length L = 0.35 m		LV434204



Accessories and Auxiliaries

ComPacT NSX100/160/250

Indication and Measurement Modules

PowerLogic PowerTag NSX

	Rating (A)	250		
	3P	LV434020		
	3P+N	LV434021		

Current transformer module

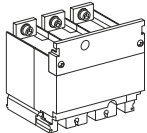
	Rating (A)	100	150	250
	3P	LV429457	LV430557	LV431567
	4P	LV429458	LV430558	LV431568

Current transformer module and voltage output

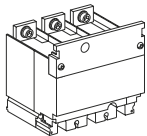
	Rating (A)	125	150	250
	3P	LV429461	LV430561	LV431569
	4P	LV429462	LV430562	LV431570

Rotary Handles

Direct rotary handle

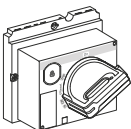
	With black handle	LV429337T
	With red handle on yellow front	LV429339T
	MCC conversion accessory	LV429341T
	CNOMO conversion accessory	LV429342T

Extended rotary handle

	With black handle	LV429338T
	With red handle on yellow front	LV429340T
	With telescopic handle for withdrawable device	LV429343T

Open door shaft operator	LV426937
--------------------------	----------

Accessories for direct or extended rotary handle

Indication auxiliary	1 early-break contact	LV429345
	2 early-make contacts	LV429346

Locks

Toggle locking device for 1 to 3 padlocks

DB438179.ai	By removable device	29370
-------------	---------------------	--------------

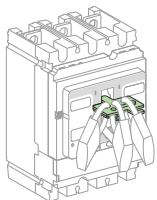

DB438180.ai	By fixed device for 3P-4P (open or close position)	LV429371
	By fixed device for 3P-4P (open position only)	LV429370

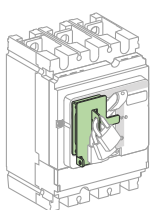

Locking of rotary handle

DB438181.ai	Keylock adapter (keylock not included)	LV429344
	Keylock (keylock adapter not included)	41940
	Profalux KS5 B24 D4Z	42888

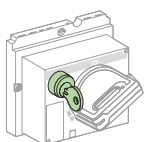

Locking of motor mechanism module

DB424485.eps	Keylock adapter + Ronis keylock (special)	LV429449
--------------	---	-----------------

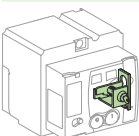

Accessories and Auxiliaries

ComPacT NSX100/160/250

Interlocking

Mechanical interlocking for circuit breakers

DB438182.ai 	With toggles	LV429354T
	With direct rotary handle	LV429369T
DB438183.ai 	With extended rotary handle	LV429369ET

Interlocking with key (2 keylocks/1 key) for rotary handles

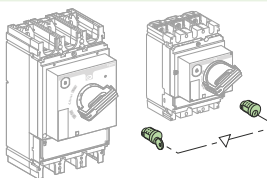
DB438184.ai 	Keylock kit (keylock not included) ^[1]	LV429344
	1 set of 2 keylocks	Ronis 1351B.500 41950
	(1 key only, keylock kit not included)	Profalux KS5 B24 D4Z 42878

Installation Accessories

Front-panel escutcheons

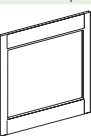
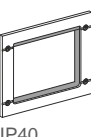
DB11269.eps 	IP30 escutcheon for all control types	LV429525
	IP30 trip unit access escutcheon for toggle	LV429526
	IP30 escutcheon for VigiPacT add-on	LV429527
DB11277.eps 	IP40 escutcheon for all control types	LV429317
	IP40 escutcheon for VigiPacT add-on	LV429316
	IP40 escutcheon for VigiPacT add-on or ammeter module	LV429318

IP43 rubber toggle cover

DB11238.eps 	1 toggle cover	LV429319 ^[2]
--	----------------	-------------------------

Lead-sealing accessories

DB115615.eps 	Bag of accessories	LV429375
---	--------------------	----------

Din rail adapter

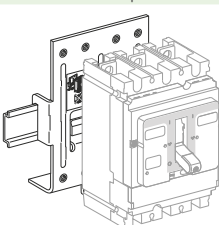
DB438185.ai 	1 adapter	LV429305
--	-----------	----------



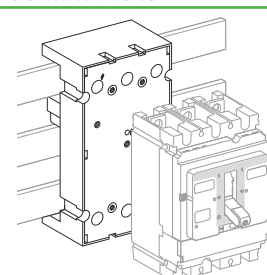







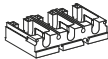

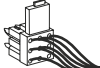

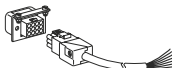
60 Mm Plate

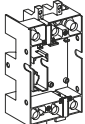
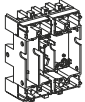
DB438186.ai 	Plate 3P ComPacT NSX100/250 IEC	LV429372
	Plate 4P ComPacT NSX100/250 IEC	LV429373

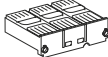
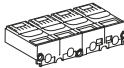
[1] For only 1 device.

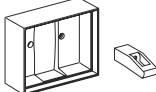
[2] Applicable with old front cover only. Need to order LV429313, toggle extension to be compatible for IP43 rubber cover.

Plug-in/Withdrawable Version Accessories

Insulation accessories			
DB117159.eps 	1 connection adapter for plug-in base	3P	LV429306
		4P	LV429307
Auxiliary connections			
DB117160.eps 	1 9-wire fixed connector (for base)		LV429273
	DB117161.eps 	1 9-wire moving connector (for circuit breaker)	
1 support for 2 moving connectors			LV429275
DB117162.eps 			LV429275
DB115935.eps 	9-wire manual auxiliary connector (fixed + moving)		LV429272
Plug-in base accessories			
DB432605.eps 	2 long insulated right angle terminal extensions	Set of 2	LV429276
DB117165.eps 	2 IP40 shutters for base		LV429271
DB117166.eps 	Base	2P (3P base)	LV429265
		3P	LV429266
DB117167.eps 	Base	4P	LV429267
DB117168.eps 	2 power connections	2/3/4P	LV429268
DB117169.eps 	1 short terminal shield	2/3P	LV429515
DB117170.eps 	1 short terminal shield	4P	LV429516
DB117171.eps 	1 safety trip interlock	2/3/4P	LV429270
Chassis accessories			
DB117172.eps 	Escutcheon collar	Toggle	LV429284 ^[1]
	Escutcheon collar	VigiPacT add-on	LV429285
DB117173.eps 			LV429285
DB117163.eps 	Locking kit (keylock not included)		LV429286
	Keylock (keylock adapter not included)	Ronis 1351B.500	41940
		Profalux KS5 B24 D4Z	42888
DB11426.eps 	2 carriage switches (connected/disconnected position indication)		LV429287

[1] Need to order LV434435, NSX front cover to be compatible for escutcheon collar for toggle.



Accessories and Auxiliaries

ComPacT NSX100/160/250

Spare Parts

DB111430.eps	5 spare toggle extensions (NSX250)		LV429313
DB115620.eps	Bag of screws		LV429312
DB111431.eps	12 snap-in nuts (fixed/FC)	M6 for NSX100N/H/L	LV429234
		M8 for NSX160/250N/H/L	LV430554
DB114317.ai	NSX100-250 front cover	3P/4P	LV434435
	Retrofit NSX100-250 front cover	3P/4P	LV43435AT
DB111433.eps	IP40 toggle escutcheon	ComPacT NS type/small cut-out	29315
DB111438.eps	1 set of 10 identification labels		LV429226
DB11438.ai	1 base for extended rotary handle		LV429502
DB111434.eps	Torque limiting screws (set of 12)	3P/4P ComPacT NSX100-250	LV429513
DB111435.eps	LCD display for electronic trip unit	MicroLogic 5	LV429483
		MicroLogic 6	LV429484
		MicroLogic 6 E-M	LV429486
DB111436.eps	5 transparent covers for trip unit	TM, MA, NA	LV429481
		MicroLogic 2	LV429481
		MicroLogic 5/6	LV429478

Visible Break Disconnect Function

See catalog dealing with "ComPacT INV products (visible break)" and the associated accessories.
The visible break disconnection function is compatible with fixed front-connected/rear-connected ComPacT NSX devices.

Communication Option

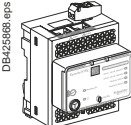
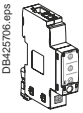
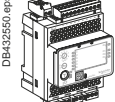
	IFE	Ethernet interface for LV breaker	LV434001
		Ethernet interface for LV breakers and gateway	LV434002
		IFM Modbus-SL interface module	LV434000
		I/O application module	LV434063

Monitoring and Control (Remote Operation)

Circuit breaker accessories

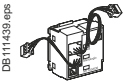
	Breaker Status Control Module	BSCM ^[1]	LV434205
---	-------------------------------	---------------------	----------







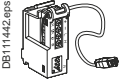

ULP display module ^[2]

	Switchboard front display module FDM121	TRV00121
	FDM mounting accessory (diameter 22 mm)	TRV00128

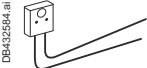
Ethernet display module

	Switchboard front display module FDM128	LV434128
---	---	----------

ULP wiring accessories

	NSX cord L = 0.35 m	LV434200
	NSX cord L = 1.3 m	LV434201
	NSX cord L = 3 m	LV434202
	NSX cord for U > 480 V AC L = 1.3 m	LV434204
	10 stacking connectors for communication interface modules	TRV00217
	2 Modbus line terminators	VW3A8306DRC ^[3]
	Connector Modbus adaptor	LV434211
	RS 485 roll cable (4 wires, length 60 m)	50965
	5 RJ45 connectors female/female	TRV00870
	10 ULP line terminators	TRV00880
	10 RJ45/RJ45 male cord L = 0.3 m	TRV00803
	10 RJ45/RJ45 male cord L = 0.6 m	TRV00806
	5 RJ45/RJ45 male cord L = 1 m	TRV00810
	5 RJ45/RJ45 male cord L = 2 m	TRV00820
	5 RJ45/RJ45 male cord L = 3 m	TRV00830
	1 RJ45/RJ45 male cord L = 5 m	TRV00850

^[1] SDE adapter mandatory for trip unit TM, MA or MicroLogic 2 (LV429451).



^[2] For measurement display with MicroLogic E or status display with BSCM.

^[3] www.schneider-electric.com.

Accessories and Auxiliaries

ComPacT NSX100/160/250

Test Tool, Software, Demo

Test tool	
 <p>DB111449.eps</p>	Pocket battery for MicroLogic NSX100-630 LV434206
 <p>DB111461.eps</p>	Maintenance case Comprising: - USB maintenance interface - Power supply - MicroLogic cord - USB cord - RJ45/RJ45 male cord
 <p>DB111450.eps</p>	Spare USB maintenance interface TRV00911
 <p>DB111452.eps</p>	Spare power supply 110-240 V AC TRV00915
 <p>DB111453.eps</p>	Spare MicroLogic cord for USB maintenance interface TRV00917
 <p>DB111448.eps</p>	Bluetooth/Modbus option for USB maintenance interface VW3A8114 ^[1]

[1] See Telemecanique catalog.

Accessories

Power supply modules

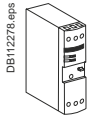

External power supply module 100-240 V AC 110-230 V DC/24 V DC-3 A class 2	ABL8RPS24030	[1]
--	---------------------	-----

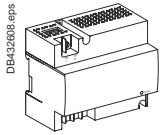

External power supply module 24 V DC-1 A OVC IV		
24-30 V DC	LV454440	
48-60 V DC	LV454441	
100-125 V DC	LV454442	
110-130 V AC	LV454443	
200-240 V AC	LV454444	

[1] See Telemecanique catalog.





F

Catalog Numbers: ComPacT NSX400-630

Complete Fixed Device F-50
Com**PacT** NSX400/630F (36 KA 380/415 V) F-50
Com**PacT** NSX400/630N (50 KA 380/415 V)..... F-51
Com**PacT** NSX400/630H (70 KA 380/415 V)..... F-52
Com**PacT** NSX400/630R (200 KA 380/415 V - 45 KA 690 V) F-53
Com**PacT** NSX400/630HB1 (85 KA 500 V - 75 KA 690 V)..... F-54
Com**PacT** NSX400/630HB2 (85 KA 500 V - 100 KA 690 V)..... F-55
Com**PacT** NSX400/630NA
Com**PacT** NSX400K (10 KA - 1000V AC)..... F-56

Based on Separate Components F-57
Com**PacT** NSX400/630 F-57

Trip Unit Accessories F-59
Com**PacT** NSX400/630 F-59

Installation and Connection..... F-60
Com**PacT** NSX400/630 F-60

Communication, Monitoring and Control..... F-70
Com**PacT** NSX400/630 F-70

Monitoring and Control, Accessories F-71
Com**PacT** NSX400/630 F-71

Source-Changeover Systems for 2 Devices..... F-72
Com**PacT** NSX100 to NSX630 F-72

ComPacT NSX100 to NSX630 Order Form F-74



Other Chapters

Select Circuit Breakers and Switch-Disconnectors A-1
Select Protection B-1
Customize Circuit Breakers with Accessories..... C-1
Smart Panel Integration D-1
Switchboard Integration..... E-1
Glossary G-1
Additional Characteristics..... H-1

Complete Fixed Device

ComPacT NSX400/630F (36 KA 380/415 V)

ComPacT NSX400/630F

Electronic trip unit MicroLogic 2.3 (LS_oI protection)

DB439189.ai

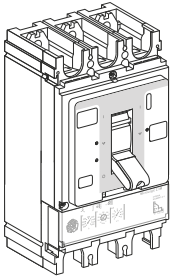

		3P 3d	4P 3d, 4d, 3d + N/2
ComPacT NSX400F (36 kA at 380/415 V)	250 A	C40F32D250	C40F42D250
	400 A	C40F32D400	C40F42D400
ComPacT NSX630F (36 kA at 380/415 V)	630 A	C63F32D630	C63F42D630

Electronic trip unit MicroLogic Vigi 4.3 (LS_oIR protection)

DB439190.ai

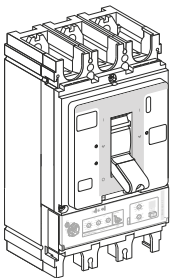

		3P 3d	4P 4d 3d + N/2
ComPacT NSX400F (36 kA at 380/415 V)	400 A	C40F34V400	C40F44V400
	570 A	C63F34V570	C63F44V570

Electronic trip unit MicroLogic Vigi 7.3 E (LSIR protection + embedded energy management)

DB439191.ai

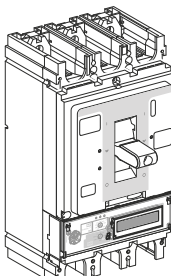

		3P 3d	4P 4d, 3d + N/2
ComPacT NSX400F (36 kA at 380/415V)	400 A	C40F37E400	C40F47E400
	570 A	C63F37E570	C63F47E570

Electronic trip unit MicroLogic 1.3 M (I motor protection)

DB439191.ai

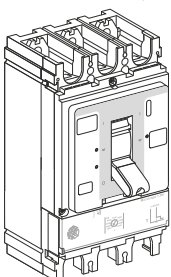

		3P 3d
ComPacT NSX400F 1.3 M (36 kA at 380/415V)	320 A	C40F31M320
	500 A	C63F31M500

Electronic trip unit MicroLogic 2.3 M (LS_oI motor protection)

DB439192.ai

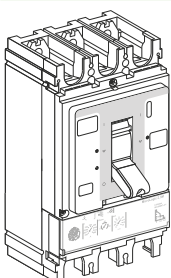

		3P 3d
ComPacT NSX400F 2.3 M (36 kA at 380/415V)	320 A	C40F32M320
	500 A	C63F32M500

With electronic trip unit MicroLogic 5.3 E (LSI protection, energy meter)

Only available as separate component or through online configurator (product selector)

With electronic trip unit MicroLogic 6.3 E (LSIG protection, energy meter)

Only available as separate component or through online configurator (product selector)

With electronic trip unit MicroLogic 6.3 E-M (LSIG motor protection, energy meter)

Only available as separate component or through online configurator (product selector)

With electronic trip unit MicroLogic 7.3 E (LSIG protection, energy meter)

Only available as separate component or through online configurator (product selector)

F

Complete Fixed Device

ComPacT NSX400/630N (50 KA 380/415 V)

ComPacT NSX400/630N

Electronic trip unit MicroLogic 2.3 (LS₀I protection)

DB438199.ai

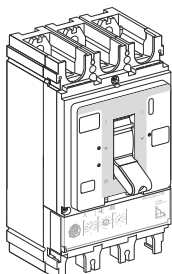

ComPacT NSX400N (50 kA at 380/415 V)	250 A	3P 3d C40N32D250	4P 3d, 4d, 3d + N/2 C40N42D250
	400 A	C40N32D400	C40N42D400
ComPacT NSX630N (50 kA at 380/415 V)	630 A	C63N32D630	C63N42D630

Electronic trip unit MicroLogic Vigi 4.3 (LS₀IR protection)

DB438190.ai

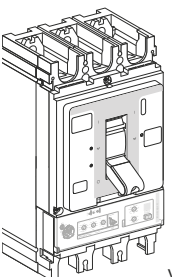

ComPacT NSX400N (50 kA at 380/415 V)	400 A	3P 3d C40N34V400	4P 4d 3d + N/2 C40N44V400
ComPacT NSX630N (50 kA at 380/415 V)	570 A	C63N34V570	C63N44V570

Electronic trip unit MicroLogic Vigi 7.3 E (LSIR protection + embedded energy management)

DB438568.ai

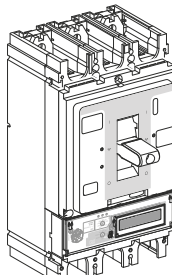

ComPacT NSX400N (36 kA at 380/415V)	400 A	3P 3d C40N37E400	4P 4d, 3d + N/2 C40N47E400
ComPacT NSX630N (36 kA at 380/415 V)	570 A	C63N37E570	C63N47E570

Electronic trip unit MicroLogic 1.3 M A (I motor protection)

DB438191.ai

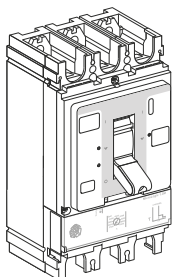

ComPacT NSX400N 1.3 M (50 kA at 380/415V)	320 A	3P 3d C40N31M320	
ComPacT NSX630N 1.3 M (50 kA at 380/415V)	500 A	C63N31M500	

Electronic trip unit MicroLogic 2.3 M (LS₀I motor protection)

DB438192.ai

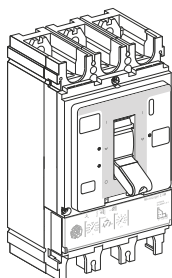

ComPacT NSX400N 2.3 M (50 kA at 380/415V)	320 A	3P 3d C40N32M320	
ComPacT NSX630N 2.3 M (50 kA at 380/415V)	500 A	C63N32M500	



Complete Fixed Device

ComPacT NSX400/630H (70 kA 380/415 V)

ComPacT NSX400/630H

Electronic trip unit MicroLogic 2.3 (LS₀I protection)

DB439109.ai

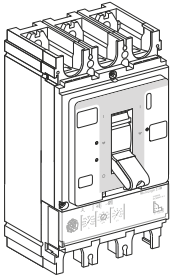

		3P 3d	4P 3d, 4d, 3d + N/2
ComPacT NSX400H (70 kA at 380/415 V)	250 A	C40H32D250	C40H42D250
	400 A	C40H32D400	C40H42D400
ComPacT NSX630H (70 kA at 380/415 V)	630 A	C63H32D630	C63H42D630

Electronic trip unit MicroLogic Vigi 4.3 (LS₀IR protection)

DB439190.ai

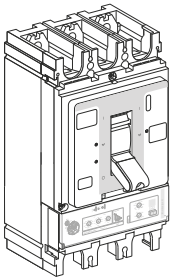

		3P 3d	4P 4d 3d + N/2
ComPacT NSX400H (70 kA at 380/415 V)	400 A	C40H34V400	C40H44V400
	570 A	C63H34V570	C63H44V570

Electronic trip unit MicroLogic Vigi 7.3 E (LSIR protection + embedded energy management)

DB438668.ai

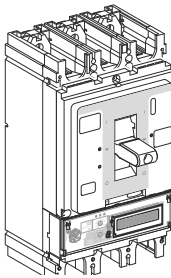

		3P 3d	4P 4d, 3d + N/2
ComPacT NSX400H (36 kA at 380/415V)	400 A	C40H37E400	C40H47E400
	570 A	C63H37E570	C63H47E570

Electronic trip unit MicroLogic 1.3 M (I motor protection)

DB438191.ai

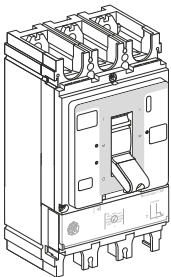

		3P 3d
ComPacT NSX400H 1.3 M (70 kA at 380/415V)	320 A	C40H31M320
	500 A	C63H31M500

Electronic trip unit MicroLogic 2.3 M (LS₀I motor protection)

DB438192.ai

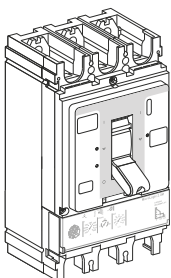

		3P 3d
ComPacT NSX400H 2.3 M (70 kA at 380/415V)	320 A	C40H32M320
	500 A	C63H32M500

With electronic trip unit MicroLogic 6.3 E (LSIG protection, energy meter)

Only available as separate component or through online configurator (product selector)

With electronic trip unit MicroLogic 6.3 E-M (LSIG motor protection, energy meter)

Only available as separate component or through online configurator (product selector)

With electronic trip unit MicroLogic 7.3 E (LSIG protection, energy meter)

Only available as separate component or through online configurator (product selector)

F

Complete Fixed Device

ComPacT NSX400/630R (200 KA 380/415 V - 45 KA 690 V)

ComPacT NSX400/630R

Electronic trip unit MicroLogic 2.3 (LS₀I protection)

DB438108.ai

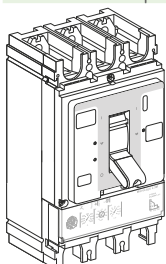

NSX400R (200 kA at 380/415 V - 45 kA at 690 V)	250 A	3P 3d	4P 3d, 4d, 3d + N/2
	400 A	C40R32D250	C40R42D250
NSX630R (200 kA at 380/415 V - 45 kA at 690 V)	630 A	C40R32D400	C40R42D400
		C63R32D630	C63R42D630

Electronic trip unit MicroLogic 5.3 E (LSI protection, energy meter)

DB438109.ai

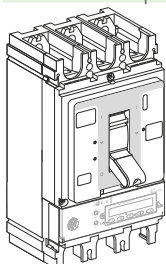

NSX400R (200 kA at 380/415 V - 45 kA at 690 V)	400 A	3P 3d	4P 3d, 4d, 3d + N/2, 3d + OSN
		C40R35E400	C40R45E400
NSX630R (200 kA at 380/415 V - 45 kA at 690 V)	630 A	C63R35E630	C63R45E630

Electronic trip unit MicroLogic 6.3 E (LSIG protection, energy meter)

DB438109.ai

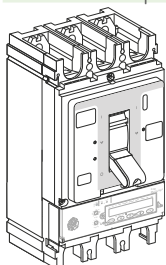

NSX400R (200 kA at 380/415 V - 45 kA at 690 V)	400 A	3P 3d	4P 3d, 4d, 3d + N/2, 3d + OSN
		C40R36E400	C40R46E400
NSX630R (200 kA at 380/415 V - 45 kA at 690 V)	630 A	C63R36E630	C63R46E630

Electronic trip unit MicroLogic 1.3 M (I motor protection)

DB438109.ai

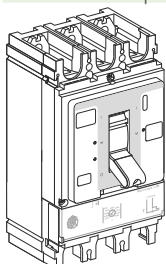

NSX400R (200 kA at 380/415 V - 45 kA at 690 V)	320 A	3P 3d	
		C40R31M320	
NSX630R (200 kA at 380/415 V - 45 kA at 690 V)	500 A	C63R31M500	

Electronic trip unit MicroLogic 2.3 M (LS₀I motor protection)

DB438109.ai

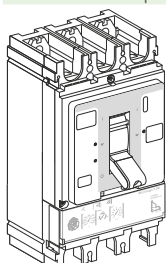

NSX400R (200 kA at 380/415 V - 45 kA at 690 V)	320 A	3P 3d	
		C40R32M320	
NSX630R (200 kA at 380/415 V - 45 kA at 690 V)	500 A	C63R32M500	

With electronic trip unit MicroLogic 6.3 E-M (LSIG motor protection, energy meter)

DB438109.ai

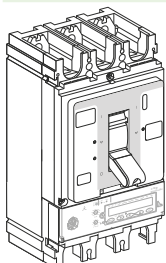

NSX400R (200 kA at 380/415 V - 45 kA at 690 V)	320 A	3P 3d	
		C40R36M320	
NSX630R (200 kA at 380/415 V - 45 kA at 690 V)	500 A	C63R36M500	

F

Complete Fixed Device

ComPacT NSX400/630HB1 (85 kA 500 V - 75 kA 690 V)

ComPacT NSX400/630HB1

Electronic trip unit MicroLogic 2.3 (LS₀I protection)

DB438189.ai

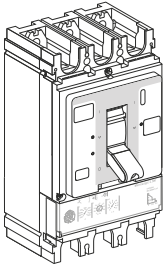

NSX400HB1 (85 kA at 500 V - 75 kA at 690 V)	250 A	3P 3d	4P 3d, 4d, 3d + N/2
	400 A	C40V32D250	C40V42D250
NSX630HB1 (85 kA at 500 V - 75 kA at 690 V)	630 A	C40V32D400	C40V42D400
		C63V32D630	C63V42D630

Electronic trip unit MicroLogic 5.3 E (LSI protection, energy meter)

DB438193.ai

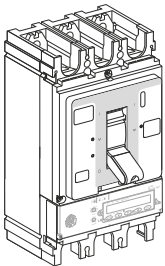

NSX400HB1 (85 kA at 500 V - 75 kA at 690 V)	400 A	3P 3d	4P 3d, 4d, 3d + N/2, 3d + OSN
		C40V35E400	C40V45E400
NSX630HB1 (85 kA at 500 V - 75 kA at 690 V)	630 A	C63V35E630	C63V45E630

Electronic trip unit MicroLogic 6.3 E (LSIG protection, energy meter)

DB438194.ai

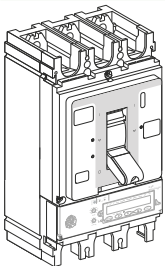

NSX400HB1 (85 kA at 500 V - 75 kA at 690 V)	400 A	3P 3d	4P 3d, 4d, 3d + N/2, 3d + OSN
		C40V36E400	C40V46E400
NSX630HB1 (85 kA at 500 V - 75 kA at 690 V)	630 A	C63V36E630	C63V46E630

Electronic trip unit MicroLogic 1.3 M (I motor protection)

DB438191.ai

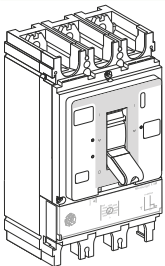

NSX400HB1 (85 kA at 500 V - 75 kA at 690 V)	320 A	3P 3d	
		C40V31M320	
NSX630HB1 (85 kA at 500 V - 75 kA at 690 V)	500 A	C63V31M500	

Electronic trip unit MicroLogic 2.3 M (LS₀I motor protection)

DB438192.ai

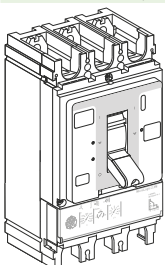

NSX400HB1 (85 kA at 500 V - 75 kA at 690 V)	320 A	3P 3d	
		C40V32M320	
NSX630HB1 (85 kA at 500 V - 75 kA at 690 V)	500 A	C63V32M500	

With electronic trip unit MicroLogic 6.3 E-M (LSIG motor protection, energy meter)

DB438195.ai

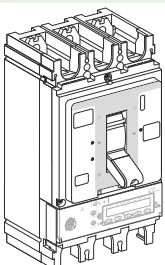

NSX400HB1 (85 kA at 500 V - 75 kA at 690 V)	320 A	3P 3d	
		C40V36M320	
NSX630HB1 (85 kA at 500 V - 75 kA at 690 V)	500 A	C63V36M500	

Complete Fixed Device

ComPacT NSX400/630HB2 (85 KA 500 V - 100 KA 690 V)

ComPacT NSX400/630HB2

Electronic trip unit MicroLogic 2.3 (LS₀I protection)

DB438189.ai

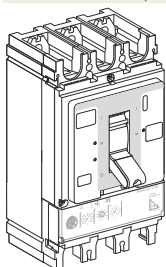

NSX400HB2 (85 kA at 500 V - 100 kA at 690 V)	250 A	3P 3d	4P 3d, 4d, 3d + N/2
	400 A	C40W32D250	C40W42D250
NSX630HB2 (85 kA at 500 V - 100 kA at 690 V)	630 A	C40W32D400	C40W42D400
		C63W32D630	C63W42D630

Electronic trip unit MicroLogic 5.3 E (LSI protection, energy meter)

DB438193.ai

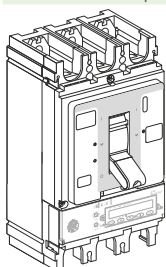

NSX400HB2 (85 kA at 500 V - 100 kA at 690 V)	400 A	3P 3d	4P 3d, 4d, 3d + N/2, 3d + OSN
		C40W35E400	C40W45E400
NSX630HB2 (85 kA at 500 V - 100 kA at 690 V)	630 A	C63W35E630	C63W45E630

Electronic trip unit MicroLogic 6.3 E (LSIG protection, energy meter)

DB438194.ai

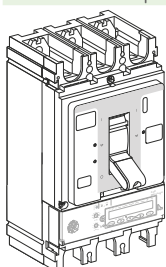

NSX400HB2 (85 kA at 500 V - 100 kA at 690 V)	400 A	3P 3d	4P 3d, 4d, 3d + N/2, 3d + OSN
		C40W36E400	C40W46E400
NSX630HB2 (85 kA at 500 V - 100 kA at 690 V)	630 A	C63W36E630	C63W46E630

Electronic trip unit MicroLogic 1.3 M (I motor protection)

DB438191.ai

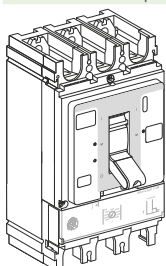

NSX400HB2 (85 kA at 500 V - 100 kA at 690 V)	320 A	3P 3d	
		C40W31M320	
NSX630HB2 (85 kA at 500 V - 100 kA at 690 V)	500 A	C63W31M500	

Electronic trip unit MicroLogic 2.3 M (LS₀I motor protection)

DB438192.ai

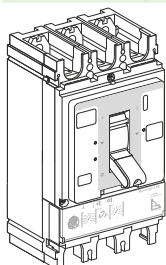

NSX400HB2 (85 kA at 500 V - 100 kA at 690 V)	320 A	3P 3d	
		C40W32M320	
NSX630HB2 (85 kA at 500 V - 100 kA at 690 V)	500 A	C63W32M500	

With electronic trip unit MicroLogic 6.3 E-M (LSIG motor protection, energy meter)

DB438195.ai

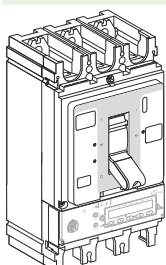

NSX400HB2 (85 kA at 500 V - 100 kA at 690 V)	320 A	3P 3d	
		C40W36M320	
NSX630HB2 (85 kA at 500 V - 100 kA at 690 V)	500 A	C63W36M500	

F

Complete Fixed Device

ComPacT NSX400/630NA

ComPacT NSX400K (10 KA - 1000V AC)

ComPacT NSX400K^[1]

Special application

DB438196.ai

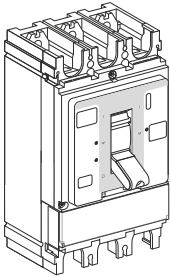

	3P	4P
ComPacT NSX400K, 250 A, MicroLogic 2.3	C40K32D250	C40K42D250
ComPacT NSX400K, 400 A, MicroLogic 2.3	C40K32D400	C40K42D400

ComPacT NSX400/630 NA Switch-Disconnecter

With NA switch-disconnector unit

DB438196.ai

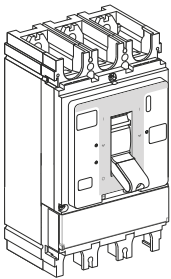

	3P	4P
ComPacT NSX400 NA	C403400S	C404400S
ComPacT NSX630 NA, 45 mm pitch	C633630S	C634630S

[1] Long or short terminal shields are mandatory.

Based on Separate Components

ComPacT NSX400/630

Basic Frame

DB425817.ai

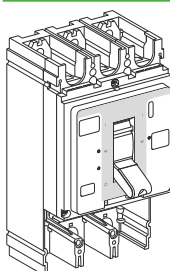

ComPacT NSX400

	3P	4P
NSX400F (36 kA 380/415 V)	C40F3	C40F4
NSX400N (50 kA 380/415 V)	C40N3	C40N4
NSX400H (70 kA 380/415 V)	C40H3	C40H4
NSX400S (100 kA 380/415 V)	C40S3	C40S4
NSX400L (150 kA 380/415 V)	C40L3	C40L4

ComPacT NSX630

	3P	4P
NSX630F (36 kA 380/415 V)	C63F3	C63F4
NSX630N (50 kA 380/415 V)	C63N3	C63N4
NSX630H (70 kA 380/415 V)	C63H3	C63H4
NSX630S (100 kA 380/415 V)	C63S3	C63S4
NSX630L (150 kA 380/415 V)	C63L3	C63L4

+ Trip Unit

Distribution protection

DB111461.eps

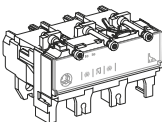
MicroLogic 2.3 (LS₀I protection)

Rating	3P 3d	4P 3d, 4d, 3d + N/2
MicroLogic 2.3 250 A	C4032D250	C4042D250
MicroLogic 2.3 400 A	C4032D400	C4042D400
MicroLogic 2.3 630 A	C6332D630	C6342D630

DB111462.eps

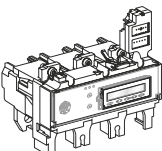

MicroLogic 5.3 E (LSI protection, energy meter)

Rating	3P 3d	4P 3d, 4d, 3d + N/2, 3d + OSN
MicroLogic 5.3 E 400 A	C6335E400	C6345E400
MicroLogic 5.3 E 630 A	C6335E630	C6345E630

DB111462.eps

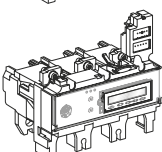

MicroLogic 6.3 E (LSIG protection, energy meter)

Rating	3P 3d	4P 3d, 4d, 3d + N/2, 3d + OSN
MicroLogic 6.3 E 400 A	C4036E400	C4046E400
MicroLogic 6.3 E 630 A	C6336E630	C6346E630

Distribution protection with embedded earth leakage protection

DB425817.eps

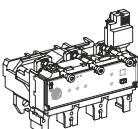
With electronic trip unit MicroLogic Vigi 4.3 (LS₀IR protection)

Rating	3P 3d	4P 4d 3d + N/2
400 A	C4034V400	C4044V400
570 A	C6334V570	C6344V570

DB425819.eps

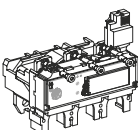

With electronic trip unit MicroLogic Vigi 7.3 E (LSIR protection)

Rating	3P 3d	4P 4d 3d + N/2
400 A	C4037E400	C4047E400
570 A	C6337E570	C6347E570

Distribution protection with embedded earth leakage protection alarm

DB425816.eps

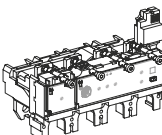
With electronic trip unit MicroLogic Vigi 4.3 AL (LS₀I protection + earth leakage alarm)

Rating	3P 3d	4P 4d 3d + N/2
400 A	C4034A400	C4044A400
570 A	C6334A570	C6344A570

DB425820.eps

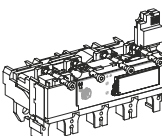

With electronic trip unit MicroLogic Vigi 7.3 E AL (LSI protection + earth leakage alarm)

Rating	3P 3d	4P 4d 3d + N/2
400 A	C4037A400	C4047A400
570 A	C6337A570	C6347A570

F

Based on Separate Components

ComPacT NSX400/630

+ Trip Unit

Motor protection

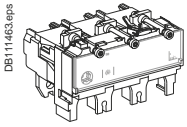

MicroLogic 1.3 M (I protection)

Rating	3P 3d	4P 3d
MicroLogic 1.3 M 320 A	C4031M320	C4041M320
MicroLogic 1.3 M 500 A	C6331M500	C6341M500

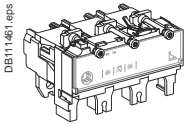

MicroLogic 2.3 M (LS₀I protection)

Rating	3P 3d
MicroLogic 2.3 M 320 A	C4032M320
MicroLogic 2.3 M 500 A	C6332M500

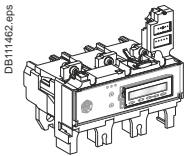

MicroLogic 6.3 E-M (LSIG protection, energy meter)

Rating	3P 3d
MicroLogic 6.3 E-M 320 A	C4036M320
MicroLogic 6.3 E-M 500 A	C6336M500

Protection of public distribution systems

MicroLogic 2.3 AB (LS₀I protection)

Rating	4P 3d, 4d, 3d + N/2
MicroLogic 2.3 400 A	C4042B400

16 Hz 2/3 network protection

MicroLogic 5.3 A-Z (LSI protection, ammeter)

Rating	3P 3d
MicroLogic 5.3 A-Z 630 A	C6335Z630

Earth Leakage protection of public distribution systems

MicroLogic Vigi 4.3 AB distribution protections

Rating	4P 4d 3d + N/2
400 A	C4044B400

+ VigiPacT add-on Protection and Alarm Modules

VigiPacT add-on protection

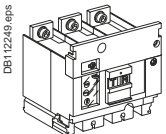

200 to 440 V	3P	4P
440 to 550 V	LV432464	LV432465
Connection for a 4P VigiPacT on a 3P breaker	LV432466	LV432467
		LV432457

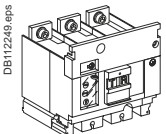

VigiPacT add-on alarm



200 to 440 V	3P	4P
Connection for a 4P insulation monitoring module on a 3P breaker	LV432469	LV432470
		LV432457

F

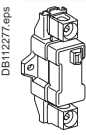
Trip Unit Accessories

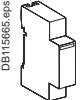
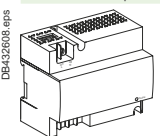
External neutral CT for 3 pole breaker with MicroLogic 5/6		
 DB112277.eps	400-630 A	LV432575
24 V DC wiring accessory for MicroLogic 5/6		
 DB112730.eps	24 V DC power supply connector	LV434210
ZSI accessory for NS630b-NW with NSX		
 DB115685.eps	ZSI module	LV434212
External power supply module (24 V DC - 1 A), class 4		
 DB432608.eps	24-30 V DC	LV454440
	48-60 V DC	LV454441
	100-125 V DC	LV454442
	110-130 V AC	LV454443
	200-240 V AC	LV454444



Installation and Connection

ComPacT NSX400/630

Fixed/RC Device = Fixed/FC Device + Rear Connection Kit

Mixed RC kit

DB4381199.ai

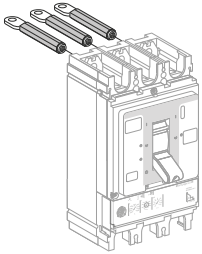

Kit 3P	Short RCs	2 x	LV432475
	Long RCs	1 x	LV432476
Kit 4P	Short RCs	2 x	LV432475
	Long RCs	2 x	LV432476

Plug-in Version = Fixed/FC Device + Plug-in Kit

Kit for ComPacT NSX

DB4381199.ai

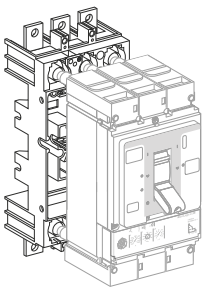

	3P	4P
Plug-in kit	LV432538	LV432539
Comprising:		
Base	= 1 x LV432516	= 1 x LV432517
Power connections	+ 3 x LV432518	+ 4 x LV432518
Short terminal shields	+ 2 x LV432591	+ 2 x LV432592
Safety trip interlock	+ 1 x LV432520	+ 1 x LV432520

Kit for ComPacT NSX VigiPacT add-on

Kit for ComPacT NSX

<Standardfile>

	3P	4P
ComPacT NSX Vigi add-on plug-in kit	LV432540	LV432541
Comprising:		
Base	= 1 x LV432516	= 1 x LV432517
Power connections	+ 3 x LV432519	+ 4 x LV432519
Short terminal shields	+ 2 x LV432591	+ 2 x LV432592
Safety trip interlock	+ 1 x LV432520	+ 1 x LV432520

Installation and Connection

ComPacT NSX400/630

Withdrawable Version = Fixed/FC Device + Withdrawable Kit

Kit for ComPacT NSX

DB43200.ai

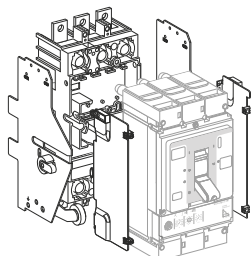

	3P	4P
	Kit for ComPacT NSX	Kit for ComPacT NSX
	=	=
Plug-in kit:	1 x LV432538	1 x LV432539
	+	+
Chassis side plates for base	1 x LV432532	1 x LV432532
	+	+
Chassis side plates for breaker	1 x LV432533	1 x LV432533

Kit for ComPacT NSX Vigi add-on

DB117174.eps

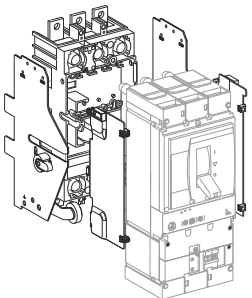









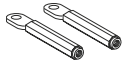

	3P	4P
	Kit for ComPacT NSX Vigi add-on	Kit for ComPacT NSX Vigi add-on
	=	=
Plug-in kit:	1 x LV432540	1 x LV432541
	+	+
Chassis side plates for base	1 x LV432532	1 x LV432532
	+	+
Chassis side plates for breaker	1 x LV432533	1 x LV432533

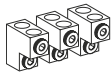

Accessories and Auxiliaries

ComPacT NSX400/630

Connection Accessories (Cu or Al)

Rear connections				
DB11471.eps 	2 short			LV432475
	2 long			LV432476
Bare cable connectors ^[1]				
DB115624.eps 	Aluminium connectors	1 x (35 to 300 mm ²)	Set of 3	LV432479
			Set of 4	LV432480
DB115625.eps 	Aluminium connectors for 2 cables	2 x (35 to 240 mm ²)	Set of 3	LV432481
			Set of 4	LV432482
DB112724.eps 	6.35 mm voltage tap for aluminium connectors for 1 or 2 cables		Set of 10	LV429348
Terminal extensions ^[1]				
DB115648.eps 	45° terminal extensions		Set of 3	LV432586
			Set of 4	LV432587
DB115650.eps 	Edgewise terminal extensions		Set of 3	LV432486
			Set of 4	LV432487
DB115651.eps 	Right-angle terminal extensions		Set of 3	LV432484
			Set of 4	LV432485
DB115652.eps 	Spreaders	52.5 mm	3P	LV432490
			4P	LV432491
		70 mm	3P	LV432492
			4P	LV432493
Crimp lugs for copper cable ^[1]				
DB112377.eps 	For cable 240 mm ²		Set of 3	LV432500
			Set of 4	LV432501
	For cable 300 mm ²		Set of 3	LV432502
			Set of 4	LV432503
Crimp lugs for aluminium cable ^[1]				
DB112238.eps 	For cable 240 mm ²		Set of 3	LV432504
			Set of 4	LV432505
	For cable 300 mm ²		Set of 3	LV432506
			Set of 4	LV432507
Supplied with 2 or 3 interphase barriers				

[1] Supplied with 2 or 3 interphase barriers.

Insulation accessories

DB425467.eps 	Short terminal shield, 45 mm (1 piece)	3P	LV432591
		4P	LV432592
DB117183.eps DB117184.eps 	Short terminal shield > 500 V (1 piece)	3P	LV433693
		4P	LV433694
DB425468.eps 	Long terminal shield, 45 mm (1 piece)	3P	LV432593
		4P	LV432594
DB425469.eps 	Long terminal shield for spreaders, 52.5 mm (1 piece) (supplied with insulating plate)	3P	LV432595
		4P	LV432596
DB425470.eps 	Interphase barriers	Set of 6	LV432570
DB425471.eps 	Connection adapter for plug-in base	3P	LV432584
		4P	LV432585
DB438201.ai 	2 insulating screens (70 mm pitch)	3P	LV432578
		4P	LV432579



Accessories and Auxiliaries

ComPacT NSX400/630

Electrical Auxiliaries

Auxiliary contacts (wired, screwless)

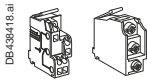

OF or SD or SDE or SDV screwless type	29450
OF or SD or SDE or SDV low level screw type	29452

Auxiliary contacts (wireless)



OF or SD or SDE wireless	LV429454
--------------------------	----------

SDx output module for MicroLogic electronic trip unit

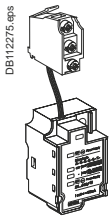

SDx module 24/415 V AC/DC screw type	LV429532
--------------------------------------	----------

SDTAM contactor tripping module (early-break thermal fault signal) for MicroLogic 2.3 M/6.3 E-M

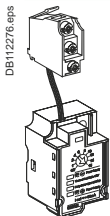

SDTAM 24/415 V AC/DC overload fault indication	LV429424
--	----------

Voltage releases

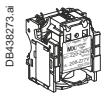

	Voltage	MX	MN
AC	24 V 50/60 Hz	LV429384	LV429404
	48 V 50/60 Hz	LV429385	LV429405
	110-130 V 50/60 Hz	LV429386	LV429406
	220-240 V 50/60 Hz and 208-277 V 60 Hz	LV429387	LV429407
	380-415 V 50 Hz and 440-480 V 60 Hz	LV429388	LV429408
	525 V 50 Hz and 600 V 60 Hz	LV429389	LV429409
DC	12 V	LV429382	LV429402
	24 V	LV429390	LV429410
	30 V	LV429391	LV429411
	48 V	LV429392	LV429412
	60 V	LV429383	LV429403
	125 V	LV429393	LV429413
	250 V	LV429394	LV429414

MN 48 V 50/60 Hz with fixed time delay			
Composed of:	MN 48 V DC		LV429412
	Delay unit 48 V 50/60 Hz		LV429426

MN 220-240 V 50/60 Hz with fixed time delay			
Composed of:	MN 250 V DC		LV429414
	Delay unit 220-240 V 50/60 Hz		LV429427

MN 48 V DC/AC 50/60 Hz with adjustable time delay			
Composed of:	MN 48 V DC		LV429412
	Delay unit 48 V DC/AC 50/60 Hz		33680

MN 110-130 V DC/AC 50/60 Hz with adjustable time delay			
Composed of:	MN 125 V DC		LV429413
	Delay unit 100-130 V DC/AC 50/60 Hz		33681

MN 220-250 V DC/AC 50/60 Hz with adjustable time delay			
Composed of:	MN 250 V DC		LV429414
	Delay unit 200-250 V DC/AC 50-60 Hz		33682

F

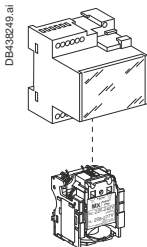

Motor Mechanism

Motor mechanism module

DB111475.eps

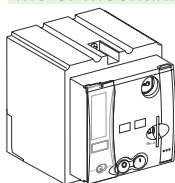

	Voltage	MT400-630
AC	48-60 V 50/60 Hz	LV432639
	110-130 V 50/60 Hz	LV432640
	220-240 V 50/60 Hz and 208-277 V 60 Hz	LV432641
	380-415 V 50 Hz	LV432642
	440-480 V 60 Hz	LV432647
DC	24-30 V	LV432643
	48-60 V	LV432644
	110-130 V	LV432645
	250 V	LV432646
Operation counter		LV432648

Communicating motor mechanism module

DB111476.eps

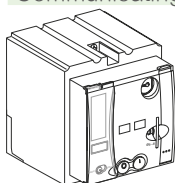

Motor mechanism module	MTc 400/630	220-240 V 50/60 Hz	LV432652
------------------------	-------------	--------------------	----------

+

Breaker status Communication Module	BSCM	LV434205
--	------	----------

+

NSX cord	Wire length L = 0.35 m	LV434200
	Wire length L = 1.3 m	LV434201
	Wire length L = 3 m	LV434202
	U > 480 V AC wire length L = 0.35 m	LV434204

Indication and Measurement Modules

PowerLogic PowerTag NSX

DB430747.eps

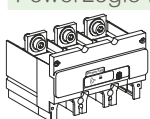

Rating (A)	630
3P	LV434022
3P+N	LV434023

Current transformer module

DB11779.eps

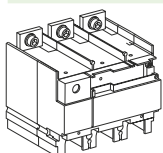

Rating (A)	400	630
3P	LV432657	LV432857
4P	LV432658	LV432858

Current transformer module and voltage output

DB11779.eps

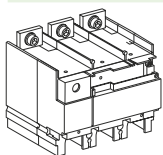

Rating (A)	400	600
3P	LV432653	LV432861
4P	LV432654	LV432862

F

Accessories and Auxiliaries

ComPacT NSX400/630

Rotary Handles

Direct rotary handle

DB438202.ai

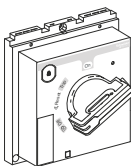

With black handle	LV432597T
With red handle on yellow front	LV432599T
MCC conversion accessory	LV432606T
CNOMO conversion accessory	LV432602T

Extended rotary handle

DB438203.ai

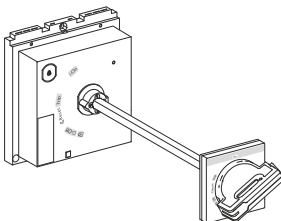

With black handle	LV432598T
With red handle on yellow front	LV432600T
With telescopic handle for withdrawable device	LV432603T

DB421689.eps



Open door shaft operator	LV426937
--------------------------	----------

Accessories for direct or extended rotary handle

Indication auxiliary	1 early-break contact	LV432605
	2 early-make contacts	LV429346

Locks

Toggle locking device for 1 to 3 padlocks

DB438204.ai

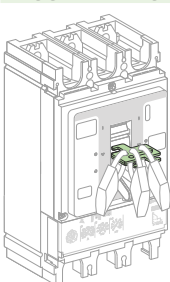

By removable device	29370
---------------------	-------

DB438205.ai

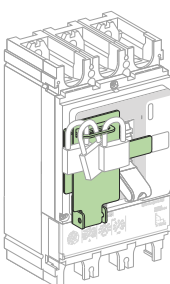

By fixed device for 3P, 4P (open or close position)	LV432631
By fixed device for 3P, 4P (for open position only)	LV432630

Locking of rotary handle

DB438206.ai

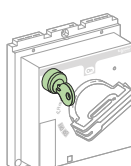

Keylock adapter (keylock not included)	LV432604	
Keylock (keylock adapter not included)	Ronis 1351B.500	41940
	Profalux KS5 B24 D4Z	42888

Locking of motor mechanism module

DB425475.eps

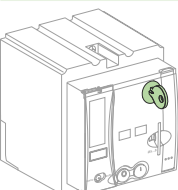

Keylock adapter (keylock not included)	LV432649	
Keylock (keylock adapter not included)	Ronis 1351B.500	41940
	Profalux KS5 B24 D4Z	42888

Interlocking

Mechanical interlocking for circuit breakers

DB438419.ai		With toggles	LV432614T
		With direct rotary handle	LV432621T
DB438420.ai		With extended rotary handle	LV432621ET

Interlocking with key (2 keylocks/1 key) for rotary handles

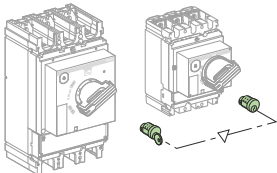
DB438164.ai		Keylock kit (keylock not included) ^[1]	LV432604
		1 set of 2 keylocks	Ronis 1351B.500 41950
		(1 key only, keylock kit not included)	Profalux KS5 B24 D4Z 42878

Installation Accessories

Front-panel escutcheons

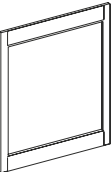
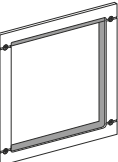
DB111488.eps		IP30 escutcheon for all control types	LV432557
		IP30 trip unit access escutcheon for toggle	LV432559
		IP30 escutcheon for VigiPacT add-on	LV429527
IP30			
DB111489.eps		IP40 escutcheon for all control types	LV432558
		IP40 escutcheon for VigiPacT add-on	LV429316
		IP40 escutcheon for VigiPacT add-on or ammeter module	LV429318
IP40			

IP43 rubber toggle cover

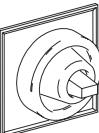
DB111490.eps		1 toggle cover	LV432560 ^[2]
--------------	---	----------------	-------------------------

Lead-sealing accessories

DB115615.eps		Bag of accessories	LV429375
--------------	---	--------------------	----------

60 Mm Plate

DB43207.ai		Plate 3P ComPacT NSX400/630 IEC	LV432623
		Plate 4P ComPacT NSX400/630 IEC	LV432624











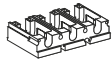

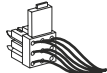
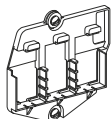
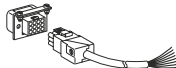
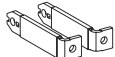
[1] For only 1 device.

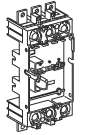
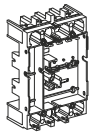
[2] Need to order LV432553, toggle extension to be compatible for IP43 rubber cover.

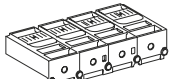
Accessories and Auxiliaries

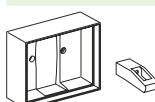

ComPacT NSX400/630

Plug-in/Withdrawable Version Accessories

Insulation accessories			
	Connection adapter for plug-in base	3P	LV432584
		4P	LV432585
Auxiliary connections			
	1 9-wire fixed connector (for base)		LV429273
	1 9-wire moving connector (for circuit breaker)		LV432523
	1 support for 3 moving connectors		LV432525
	9-wire manual auxiliary connector (fixed + moving)		LV429272
Plug-in base accessories			
	Long insulated right angle terminal extensions	Set of 2	LV432526
	2 IP40 shutters for base		LV432521
	Base	3P	LV432516
	Base	4P	LV432517
	Power connections	3/4P	LV432518
	Short terminal shields	3P	LV432591
	Short terminal shield > 500 V (1 piece)	3P	LV433693
	Short terminal shields	4P	LV432592
	Short terminal shield > 500 V (1 piece)	4P	LV433694
	Safety trip interlock	3/4P	LV432520
Chassis accessories			
	Escutcheon collar	Toggle	LV432534 ^[1]
	Escutcheon collar	VigiPacT add-on	LV429285
	Locking kit (keylock not included)		LV429286
	Keylock (keylock adapter not included)	Ronis 1351B.500	41940
		Profalux KS5 B24 D4Z	42888
	2 carriage switches (connected/disconnected position indication)		LV429287

[1] Need to order LV434436, NSX front cover to be compatible for escutcheon collar for toggle.

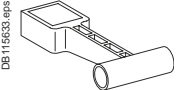
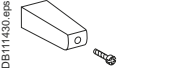
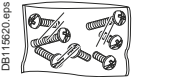
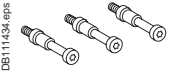
Spare Parts

	Additional toggle extension for NSX400/630		32595 ^[1]
	5 spare toggle extensions		LV432553
	Bag of screws		LV432552
	NSX400-630 front cover	3P/4P	LV434436
	Retrofit NSX400-630 front cover (F/N/H)	3P/4P	LV4344ALT
	NSX400-630 front cover (R/HB1/HB2)	3P/4P	LV4344AHT
	IP40 toggle escutcheon	ComPacT NS type/small cut-out	32556
	Torque limiting screws (set of 12)	3P/4P ComPacT NSX400-630	LV432513
	1 set of 10 identification labels		LV429226
	1 base for extended rotary handle		LV432498
		LCD display for electronic trip unit	MicroLogic 5
		MicroLogic 6	LV429484
		MicroLogic E-M	LV429486
	5 transparent covers for electronic trip unit	MicroLogic 5/6	LV432459
		MicroLogic 2	LV432461

Individual Enclosures

IP55 steel enclosure

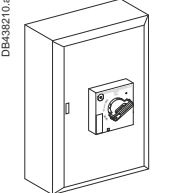
	ComPacT NSX400 with black extended rotary handle	LV431219
	ComPacT NSX400 with red and yellow extended rotary handle	LV431220
	ComPacT NSX630 or ComPacT NSX400/630 VigiPacT add-on with black extended rotary handle	LV431221
	ComPacT NSX630 or ComPacT NSX400/630 VigiPacT add-on with red and yellow extended rotary handle	LV431222

IP55 insulating enclosure

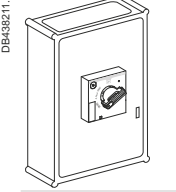
	ComPacT NSX400/630 with black extended rotary handle	LV432665
	ComPacT NSX400/630 VigiPacT add-on with black extended rotary handle	LV432666

Visible Break Disconnect Function

See catalog dealing with "ComPacT INV products (visible break)" and the associated accessories. The visible break disconnection function is compatible with fixed front-connected/rear-connected ComPacT NSX devices.

[1] Need to order LV432553, NSX front cover to be compatible for escutcheon collar for toggle.



Communication, Monitoring and Control

ComPacT NSX400/630

Communication Option

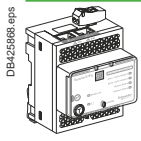
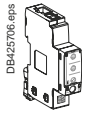
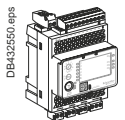
	IFE	Ethernet interface for LV breaker	LV434001
		Ethernet interface for LV breakers and gateway	LV434002
	IFM Modbus-SL interface module		LV434000
	I/O application module		LV434063

Monitoring and Control (Remote Operation)

Circuit breaker accessories

	Breaker Status Control Module	BSCM ^[1]	LV434205
--	-------------------------------	---------------------	----------





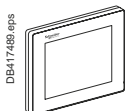

ULP display module^[2]

	Switchboard front display module FDM121		TRV00121
	FDM mounting accessory (diameter 22 mm)		TRV00128

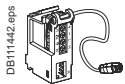
Ethernet display module

	Switchboard front display module FDM128		LV434128
--	---	--	----------

ULP wiring accessories

	NSX cord L = 0.35 m		LV434200
	NSX cord L = 1.3 m		LV434201
	NSX cord L = 3 m		LV434202
	NSX cord for U > 480 V AC L = 1.3 m		LV434204
	10 stacking connectors for communication interface modules		TRV00217
	2 Modbus line terminators		VW3A8306DRC ^[3]
	Connector Modbus adaptor		LV434211
	RS 485 roll cable (4 wires, length 60 m)		50965
	5 RJ45 connectors female/female		TRV00870
	10 ULP line terminators		TRV00880
	10 RJ45/RJ45 male cord L = 0.3 m		TRV00803
	10 RJ45/RJ45 male cord L = 0.6 m		TRV00806
	5 RJ45/RJ45 male cord L = 1 m		TRV00810
	5 RJ45/RJ45 male cord L = 2 m		TRV00820
	5 RJ45/RJ45 male cord L = 3 m		TRV00830
	1 RJ45/RJ45 male cord L = 5 m		TRV00850

[1] SDE adapter mandatory for trip unit TM, MA or MicroLogic 2 (LV429451).

[2] For measurement display with MicroLogic E or status display with BSCM.

[3] www.schneider-electric.com.

Monitoring and Control, Accessories

ComPacT NSX400/630

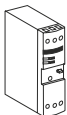
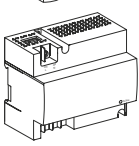

Accessories

Power supply modules

DB112276.eps		External power supply module 100-240 V AC 110-230 V DC/24 V DC-3 A class 2	ABL8RPS24030 ^[1]
DB432608.eps		External power supply module 24 V DC-1 A OVC IV 24-30 V DC 48-60 V DC 100-125 V DC 110-130 V AC 200-240 V AC	LV454440 LV454441 LV454442 LV454443 LV454444

Test Tool, Software, Demo

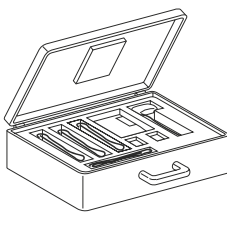
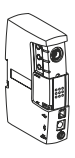
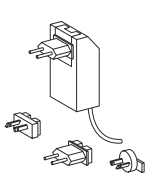
Test tool

DB111446.eps		Pocket battery for MicroLogic NSX100-630	LV434206
DB111451.eps		Maintenance case Comprising: - USB maintenance interface - Power supply - MicroLogic cord - USB cord - RJ45/RJ45 male cord	TRV00910
DB111450.eps		Spare USB maintenance interface	TRV00911
DB111452.eps		Spare power supply 110-240 V AC	TRV00915
DB111453.eps		Spare MicroLogic cord for USB maintenance interface	TRV00917
DB111448.eps		Bluetooth/Modbus option for USB maintenance interface	VW3A8114 ^[1]

[1] See Telemecanique catalog.



Source-Changeover Systems for 2 Devices

ComPacT NSX100 to NSX630

Manual Source-Changeover

Mechanical interlocking

DB439102.ai

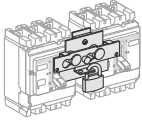

For toggle controlled circuit breakers
NSX100...250
NSX400...630

LV429354T
LV432614T

DB418508.eps

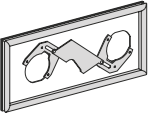

For rotary handled circuit breakers
NSX100...250
NSX400...630

LV429369T
LV432621T

Interlocking on base plate

DB439512.ai

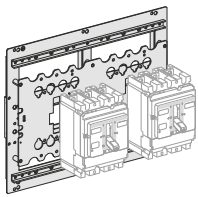

For 2 devices side by side

29349
32609

Keylock interlocking

DB439184.ai

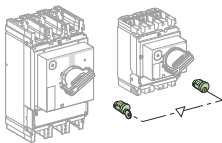

For rotary handled or remote controlled circuit breakers
2 locks, 1 key
Ronis 1351B.500
Profalux KS5 B24 D4Z

41950
42878

Connection Accessories

Downstream coupling accessories

DB101062.eps

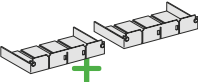

Short terminal shields (1 pair) + "S1" source/"S2" source

3P

4P

NSX100...250/NSX100...250/ 250 A

LV429358

LV429359

NSX400...630/NSX400...630/ 630 A

LV432619

LV432620

DB413273.eps

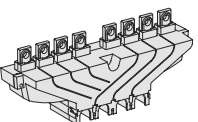

Long terminal shields (1 pair)

NSX100...250/NSX100...250

LV429518

NSX400...630/NSX400...630

LV432594

Long terminal shield for spreaders,
52.5 mm (1 piece)

LV432596

LV432596

Terminal Extensions

DB115622.eps



Spreaders 52.5 mm

4P LV432491

F

Source-Changeover Systems for 2 Devices

ComPacT NSX100 to NSX630

Typical Composition of Source-Changeover System

Remote source-changeover

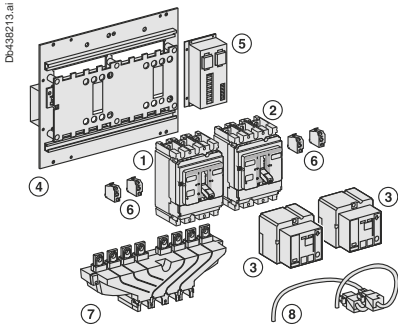

- 1 normal device N (1)
- + 1 replacement device R (2)
- + 2 remote controls (3)
- + 1 plate with interlocking (4) with IVE (5) and its wiring (8)
- + 2 plug-in kits (if plug-in version)
- + 1 adaptor kit for NSX100...250 plug-in (if NSX400...630 with NSX100...250)
- + auxiliary switches (6)
- 2 x (1 OF + 1 SDE) for ComPacT NSX100...630
- + 1 downstream coupling accessory (7) for ComPacT NSX100...630 (option)
- + long RC (if back connection)

IVE and remote controls must have the same voltage.

Associated controller

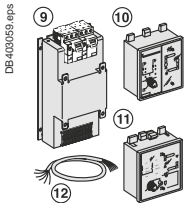

- 1 source changeover without associated controller
- + 1 ACP (9) with BA controller (10)
- Or + 1 ACP (9) with UA controller (11)
- Or + 1 ACP (9) with UA150 controller (11)
- + extension (12) for remote UA/BA connection on front of switchboard

IVE + remote control + ACP + BA or UA must have the same voltage.

Automatic Source-Changeover

Mechanical and electrical interlocking

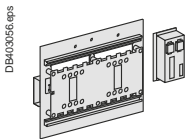

Source "normal"/source "replacement" (identical voltages)	24 to 250 V DC	48 to 415 V AC 50/60 Hz 440 V 60 Hz
NSX100...250/NSX100...250		
Plate + IVE	29351	29350
Plate	29349	29349
IVE	29356	29352
Auxiliary switches 2 OF + 2 SDE	4 x 29450	4 x 29450
Spare wiring system (device/IVE)	29365	29365
Back sockets option add: Only long RC	[2]	[2]
Plug in base option add: Plug in kit	[2]	[2]
NSX400...630/NSX100...630		
Plate + IVE	32611	32610
Plate	32609	32609
IVE	29356	29352
Auxiliary switches 2 OF + 2 SDE	4 x 29450	4 x 29450
Spare wiring system (device/IVE)	29365	29365
Back sockets option add: Only long RC	[2]	[2]
Plug in base option add: Plug in kit	[2]	[2]
Adaptator kit for NSX100...250	1 x 32618	1 x 32618

Controller

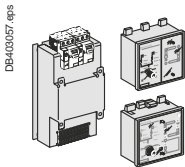

	110/127 V AC 50/60 Hz	220/240 V AC 50/60 Hz	380/415 V AC 50/60 Hz 440 V 60 Hz
ACP + controller BA [1]		29470	29471
Plate ACP		29363	29364
Controller BA		29376	29377
ACP + controller UA [1]	29448	29472	29473
Plate ACP	29447	29363	29364
Controller UA	29446	29378	29380

Wiring cable between BA/UA and ACP/IVE

Wiring cable (1.5 meter)	29368	29368
--------------------------	--------------	--------------

[1] The supply voltages BA/UA controller, ACP plate, IVE and the remote control must be identical whatever the source-changeover type.
 [2] See products pages.

NSX100/400 for Utilities, "Tarif Jaune" Public Distribution

Complete Fixed/FC Device without Accessories

ComPacT NSX with MicroLogic AB

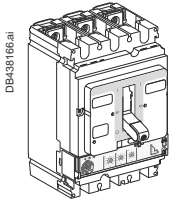

ComPacT NSX

	Rating	4P
NSX100F MicroLogic AB	100	LV434562
NSX160F MicroLogic AB	160	LV434563
NSX250F MicroLogic AB	240	LV434564
NSX400F MicroLogic AB	400	LV434565

Comprising:	Basic frame	MicroLogic AB
NSX100F + MicroLogic AB 100	LV429008	LV434550
NSX160F + MicroLogic AB 160	LV430408	LV434551
NSX250F + MicroLogic AB 240	LV431408	LV434554
NSX400F + MicroLogic AB 400	LV432415	LV434557

ComPacT NSX Vigi add-on with MicroLogic AB

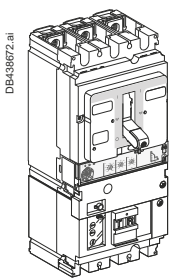

ComPacT NSX Vigi add-on

	Rating	4P
NSX100F MicroLogic AB	100	LV434572
NSX160F MicroLogic AB	160	LV434573
NSX250F MicroLogic AB	240	LV434574
NSX400F MicroLogic AB	400	LV434575

Comprising:	Basic frame	MicroLogic AB	Vigi add-on MH/MB
NSX100F + MicroLogic AB 100 + MH	LV429008	LV434550	LV429211
NSX160F + MicroLogic AB 160 + MH	LV430408	LV434551	LV429211
NSX250F + MicroLogic AB 240 + MH	LV431408	LV434554	LV431536
NSX400F + MicroLogic AB 400 + MB	LV432415	LV434557	LV432456

NSX100/400 for Utilities, "Tarif Jaune" Public Distribution

Complet Fixed/FC Device without Accessories

ComPacT NSX with normal trip unit

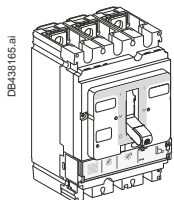

ComPacT NSX100F		
Rating	4P 3d	4P 4d
TM40D	LV429644	LV429654
TM63D	LV429642	LV429652
TM80D	LV429641	LV429651
TM100D	LV429640	LV429650
ComPacT NSX160F		
Rating	4P 3d	4P 4d
TM80D	LV430643	LV430653
TM100D	LV430642	LV430652
TM125D	LV430641	LV430651
TM160D	LV430640	LV430650
ComPacT NSX250F		
Rating	4P 3d	4P 4d
TM125D	LV431643	LV431653
TM160D	LV431642	LV431652
TM200D	LV431641	LV431651
TM250D	LV431640	LV431650
ComPacT NSX400F		
	4P 3d	4P 4d
MicroLogic 2.3	LV432677	LV432677

ComPacT NSX with normal trip unit

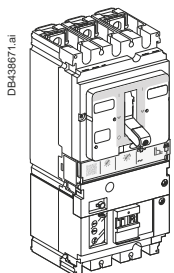

ComPacT NSX100F Vigi add-on		
Rating	4P 3d	4P 4d
TM40D	LV429944	LV429954
TM63D	LV429942	LV429952
TM80D	LV429941	LV429951
TM100D	LV429940	LV429950
ComPacT NSX160F Vigi add-on		
Rating	4P 3d	4P 4d
TM80D	LV430943	LV430953
TM100D	LV430942	LV430952
TM125D	LV430941	LV430951
TM160D	LV430940	LV430950
ComPacT NSX250F Vigi add-on		
Rating	4P 3d	4P 4d
TM125D	LV431943	LV431953
TM160D	LV431942	LV431952
TM200D	LV431941	LV431951
TM250D	LV431940	LV431950
ComPacT NSX400F Vigi add-on		
	4P 3d	4P 4d
MicroLogic 2.3	LV432732	LV432732



Catalog Numbers

NSX100/400 for Utilities, "Tarif Jaune" Public Distribution Visible Break

ComPacT INV100 to INV630 Standard Version

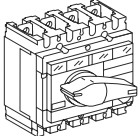
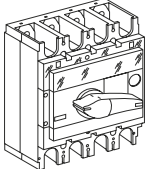
DB49873.ai 	ComPacT INV100	For ComPacT NSX100	4P 31161
	ComPacT INV160	For ComPacT NSX160	31165
	ComPacT INV200	For ComPacT NSX250	31163
	ComPacT INV250	For ComPacT NSX250	31167
DB49874.ai 	ComPacT INV320	For ComPacT NSX400	4P 31169
	ComPacT INV400	For ComPacT NSX400	31171

Spare Viewport

DB49875.ai 	For INV100 to 250	31089
	For INV320/400	31090

Combination with ComPacT NSX Devices

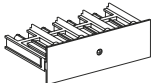
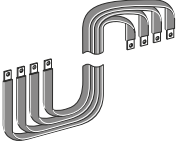
DB49876.ai 	INV100 to 250 - NSX250 combination assembly	31066
	INV320/400 - NSX250 combination assembly	31067
	Front alignment base for INV320/400 - NSX250 combination assembly	31064
	INV320/400 - NSX400 combination assembly	31068
DB49877.ai 	Flexible connection assembly for vertical INV100 to 250 with NSX horizontal N ^[1]	04443
	Flexible connection assembly for vertical INV100 to 250 with NSX horizontal V ^[1]	04444
	Flexible connection assembly for vertical INV320 to 630 with NSX horizontal N ^[1]	04445
	Flexible connection assembly for vertical INV320 to 630 with NSX horizontal V ^[1]	04446
	Flexible connection assembly for vertical INV100 to 250 with vertical NSX250 beside	31071
Flexible connection assembly for vertical INV320 to 630 with vertical NSX400/630 beside	31072	
Flexible connection assembly for vertical INV320 to 630 with vertical NSX250 beside	31093	

[1] Product sold by MGA and valid for new Prisma only.

NSX100/400 for Utilities, "Tarif Jaune" Public Distribution

Installation and Connection with or without the Visible Break Function

Conventional installation

Combination assembly

Upstream and downstream connection

INV100 to 250 - NSX100/160/250	4 snap-on bare cable connectors for cables:	1.5 to 95 mm ² ; ≤ 160 A	2x	LV429243
		10 to 185 mm ² ; ≤ 250 A	2x	LV429260
	10 clips for bare cable connector		1x	LV429241
	4 right-angle terminal extensions		2x	LV429262
	2 long terminal shields		1x	LV429518
INV320/400 - NSX100/160/250	4 bare cable connectors:	For 1 cable, 35 mm ² to 300 mm ²	1x	LV432480
		For 2 cables, 35 mm ² to 240 mm ²	1x	LV432482
	4 right-angle terminal extensions		1x	LV432485
	1 long terminal shield		1x	LV432594
	4 snap-on bare cable connectors for cables:	1.5 to 95 mm ² ; ≤ 160 A	1x	LV429243
		10 to 185 mm ² ; ≤ 250 A	1x	LV429260
	10 clips for bare cable connector		1x	LV429241
	4 right-angle terminal extensions		1x	LV429262
	1 long terminal shield		1x	LV429518
	INV320/400 - NSX400	4 bare cable connectors:	For 1 cable, 35 mm ² to 300 mm ²	2x
For 2 cables, 35 mm ² to 240 mm ²			2x	LV432482
4 right-angle terminal extensions			2x	LV432485
1 long terminal shield			1x	LV432594

Installation in cabinet or enclosure

Combination assembly (mounting in duct)

Flexible connection assembly (mounting in cubicle)

Upstream and downstream connection

INV100 to 250 - NSX100/160/250	4 snap-on bare cable connectors for cables:	1.5 to 95 mm ² ; ≤ 160 A	2x	LV429243	
		10 to 185 mm ² ; ≤ 250 A	2x	LV429260	
	1 short terminal shield		1x	LV429516	
INV320/400 - NSX100/160/250	4 bare cable connectors:	For 1 cable, 35 mm ² to 300 mm ²	1x	LV432480	
		For 2 cables, 35 mm ² to 240 mm ²	1x	LV432482	
	1 short terminal shield		1x	LV432592	
	4 snap-on bare cable connectors for cables:	1.5 to 95 mm ² ; ≤ 160 A	1x	LV429243	
		10 to 185 mm ² ; ≤ 250 A	1x	LV429260	
INV320/400 - NSX400	4 bare cable connectors:	For 1 cable, 35 mm ² to 300 mm ²	2x	LV432480	
		For 2 cables, 35 mm ² to 240 mm ²	2x	LV432482	
	1 short terminal shield		1x	LV429516	
	1 short terminal shield		1x	LV432592	

ComPacT NSX100 to NSX630 Order Form

Name of customer:
 Address for delivery:
 Requested delivery date:
 Customer order no.:

To indicate your choices, check the applicable square boxes
 or note the quantity
 and enter the appropriate information in the rectangles

Circuit breaker or switch-disconnector

ComPacT type	NSX100/160/250 - 160A not available with R, HB1 or HB2	<input type="checkbox"/>
	NSX400/630	<input type="checkbox"/>
Rating	A	<input type="checkbox"/>
Circuit breaker	B, F, N, H, S, L, R, HB1, HB2	<input type="checkbox"/>
Switch-disconnector	NA	<input type="checkbox"/>
Number of poles	1, 2, 3 or 4	<input type="checkbox"/>
Number of poles protected	2d, 3d or 4d	<input type="checkbox"/>
Fixed device	<input type="checkbox"/>	Front connections <input type="checkbox"/>
Plug-in/withdr.	Plug-in <input type="checkbox"/>	Withdrawable <input type="checkbox"/>
Earth-leakage protection	ME, MH, MB	<input type="checkbox"/>
	(not available with R, HB1 or HB2)	<input type="checkbox"/>

Trip unit

Thermal-mag.	TMD rating (16 ... 250 A) (40 ... 250 A) with R, HB1 and (63...250 A) with HB2	<input type="checkbox"/>
	TMG rating (16 ... 250 A) - not available with R, HB1 or HB2	<input type="checkbox"/>
	MA rating (2.5 ... 220 A) (12.5 ... 220 A) with R, HB1 and HB2	<input type="checkbox"/>

Electronic * Not available with R, HB1 or HB2	MicroLogic 2.2	<input type="checkbox"/>	MicroLogic 2.3	<input type="checkbox"/>
	MicroLogic 2.2 G*	<input type="checkbox"/>	MicroLogic 2.3 AB*	<input type="checkbox"/>
	MicroLogic 2.2 AB*	<input type="checkbox"/>	MicroLogic 2.3 AB*	<input type="checkbox"/>
	MicroLogic Vigi 4.2	<input type="checkbox"/>	MicroLogic Vigi 4.3 AL	<input type="checkbox"/>
	MicroLogic Vigi 4.2 AL	<input type="checkbox"/>	MicroLogic Vigi 4.3 AB	<input type="checkbox"/>
	MicroLogic Vigi 4.2 AB	<input type="checkbox"/>	MicroLogic 5.3 A*	<input type="checkbox"/>
	MicroLogic 5.2 A*	<input type="checkbox"/>	MicroLogic 5.3 E	<input type="checkbox"/>
	MicroLogic 5.2 E	<input type="checkbox"/>	MicroLogic 5.3 A-Z*	<input type="checkbox"/>
	MicroLogic 5.2 A-Z*	<input type="checkbox"/>	MicroLogic 6.3 A*	<input type="checkbox"/>
	MicroLogic 6.2 A*	<input type="checkbox"/>	MicroLogic 6.3 E	<input type="checkbox"/>
	MicroLogic 6.2 E	<input type="checkbox"/>	MicroLogic Vigi 7.3 E	<input type="checkbox"/>
	MicroLogic Vigi 7.2 E	<input type="checkbox"/>	MicroLogic Vigi 7.3 EAL	<input type="checkbox"/>
	MicroLogic Vigi 7.2 AL	<input type="checkbox"/>	MicroLogic 1.3 M	<input type="checkbox"/>
	MicroLogic 2.2 M	<input type="checkbox"/>	MicroLogic 2.3 M	<input type="checkbox"/>
	MicroLogic 6.2 E-M	<input type="checkbox"/>	MicroLogic 6.3 E-M	<input type="checkbox"/>
	SDTAM Module	<input type="checkbox"/>		<input type="checkbox"/>

External neutral CT	<input type="checkbox"/>
24 V DC power supply connector	<input type="checkbox"/>
ZSI connector accessory for plug-in and withdrawable	<input type="checkbox"/>
ZSI wiring accessory for NS630b/MTZ	<input type="checkbox"/>
External power supply module 24 V DC	<input type="checkbox"/>
24-30 V DC	<input type="checkbox"/>
100-125 V AC	<input type="checkbox"/>
200-240 V AC	<input type="checkbox"/>
48-60 V DC	<input type="checkbox"/>
110-130 V AC	<input type="checkbox"/>
Battery module	<input type="checkbox"/>

Connection

Rear-connection kit	Short <input type="checkbox"/>	Mixed <input type="checkbox"/>	Long <input type="checkbox"/>
NSX100/250 connectors	Snap-on 1.5 [□] to 95 [□] (< 160 A)	<input type="checkbox"/>	
	Snap-on 25 [□] to 95 [□] (< 250 A)	<input type="checkbox"/>	
	Snap-on 120 [□] to 185 [□] (< 250 A)	<input type="checkbox"/>	
	Distribution 6 x 1.5 [□] to 35 [□]	<input type="checkbox"/>	
	Aluminium 1 cable 25 to 95	<input type="checkbox"/>	
	Aluminium 1 cable 120 to 185	<input type="checkbox"/>	
	Aluminium 1 cable 120 to 250	<input type="checkbox"/>	
	Aluminium 2 cables 50 [□] to 120 [□]	<input type="checkbox"/>	
NSX400/630 connectors	1 cable 35 [□] to 300 [□]	<input type="checkbox"/>	
	2 cables 35 [□] to 240 [□]	<input type="checkbox"/>	
Right-angle terminal extensions	<input type="checkbox"/>		
Straight extensions	NSX100/250	<input type="checkbox"/>	
Edgewise extensions	45° terminal extension <input type="checkbox"/>	Double-L terminal extensions <input type="checkbox"/>	
Spreader	NSX100/250 (one piece)	<input type="checkbox"/>	(45 mm)
	NSX400/630 (52.5 mm)	<input type="checkbox"/>	(70 mm)
Cu cable lugs	NSX100/250	120 [□] <input type="checkbox"/>	150 [□] <input type="checkbox"/>
			185 [□] <input type="checkbox"/>
	NSX400/630		240 [□] <input type="checkbox"/>
			300 [□] <input type="checkbox"/>
Al cable lugs	NSX100/250		150 [□] <input type="checkbox"/>
			185 [□] <input type="checkbox"/>
	NSX400/630		240 [□] <input type="checkbox"/>
			300 [□] <input type="checkbox"/>
Voltage measurement	For lugs NSX100/250 ≤ 185 [□]	<input type="checkbox"/>	
Input for connector	For lugs NSX400/630	<input type="checkbox"/>	
Terminal shields	NSX100/250	Short <input type="checkbox"/>	Long <input type="checkbox"/>
	NSX400/630	Short <input type="checkbox"/>	Long <input type="checkbox"/>
		Short ≥ 50 V <input type="checkbox"/>	Long for 52.5 mm spreaders <input type="checkbox"/>
Interphase barriers	Set of 6	<input type="checkbox"/>	
2 insulating screens: NSX100/250		<input type="checkbox"/>	
	NSX400/630		70 pitch <input type="checkbox"/>

Test tool

Pocket battery for MicroLogic	<input type="checkbox"/>	Power supply 110-240 V AC	<input type="checkbox"/>
Maintenance case	<input type="checkbox"/>	Spare MicroLogic cord	<input type="checkbox"/>
USB maintenance interface	<input type="checkbox"/>		<input type="checkbox"/>

Indication and measurement

PowerLogic PowerTag NSX	<input type="checkbox"/>	3P	<input type="checkbox"/>	4P	<input type="checkbox"/>
Ammeter module	standard <input type="checkbox"/>	3P	<input type="checkbox"/>	4P	<input type="checkbox"/>
	I max <input type="checkbox"/>	3P	<input type="checkbox"/>		<input type="checkbox"/>
Current-transformer module	<input type="checkbox"/>	3P	<input type="checkbox"/>	4P	<input type="checkbox"/>
Current-transformer module + TCU	<input type="checkbox"/>	3P	<input type="checkbox"/>	4P	<input type="checkbox"/>
Insulation-monitoring module - not available with HB1 or HB2	<input type="checkbox"/>	3P	<input type="checkbox"/>	4P	<input type="checkbox"/>
Voltage-presence indicator - not available with HB1 or HB2	<input type="checkbox"/>				
Auxiliary contact	OF, SD, SDE or SDV	Standard	<input type="checkbox"/>	Low level	<input type="checkbox"/>
SDE adapter (TM, MA or MicroLogic 2 trip units)	<input type="checkbox"/>				
SDX module	<input type="checkbox"/>				

Remote operation

Electrical operation	Motor mechanism	AC	<input type="checkbox"/>	DC	<input type="checkbox"/>	V	<input type="checkbox"/>
Voltage releases	Instantaneous	MX	AC	DC	<input type="checkbox"/>	V	<input type="checkbox"/>
		MN	AC	DC	<input type="checkbox"/>	V	<input type="checkbox"/>
	Fixed time delay	MN	AC	DC	<input type="checkbox"/>	V	<input type="checkbox"/>
	Adjust. time delay	MN	AC	DC	<input type="checkbox"/>	V	<input type="checkbox"/>

Rotary handles

Direct	Black	<input type="checkbox"/>	Red and yellow front	<input type="checkbox"/>
	MCC conversion access.	<input type="checkbox"/>	CNOMO conversion access.	<input type="checkbox"/>
Extended	Black	<input type="checkbox"/>	Red and yellow front	<input type="checkbox"/>
	Telescopic handle for withdrawable device	<input type="checkbox"/>		<input type="checkbox"/>
	Open door shaft operator	<input type="checkbox"/>		<input type="checkbox"/>
Indication auxiliary	1 early-break switch	<input type="checkbox"/>	2 early-make switches	<input type="checkbox"/>

Locking

Toggle (1 to 3 padlocks)	Removable <input type="checkbox"/>	Fixed <input type="checkbox"/>
Rotary handle	Keylock adapter (keylock not included)	<input type="checkbox"/>
	Keylocks Ronis 1351B.500	<input type="checkbox"/>
	Profalux KS5 B24 D4Z	<input type="checkbox"/>
Motor mechanism	Keylock adapter + keylock Ronis (special)	<input type="checkbox"/>
	Keylock adapter (keylock not included)	<input type="checkbox"/>
	Keylocks Ronis 1351B.500	<input type="checkbox"/>
	Profalux KS5 B24 D4Z	<input type="checkbox"/>

Interlocking

Mechanical	Toggle operated	<input type="checkbox"/>	Rotary Handle	<input type="checkbox"/>
By key (2 keylocks, 1 key)	Locking kit without locks	<input type="checkbox"/>		<input type="checkbox"/>
For rotary handle	Keylocks Ronis 1351B.500	<input type="checkbox"/>	Profalux KS5 B24 D4Z	<input type="checkbox"/>

Installation accessories

IP30 escutcheon for all types (toggle/rotary handle/motor mechanism)	<input type="checkbox"/>
IP30 escutcheon (with access to toggle + trip unit)	<input type="checkbox"/>
IP30 escutcheon for VigiPacT add-on	<input type="checkbox"/>
IP40 escutcheon for all types (toggle/rotary handle/motor mechanism)	<input type="checkbox"/>
IP40 escutcheon for VigiPacT add-on	<input type="checkbox"/>
IP40 escutcheon for VigiPacT add-on or ammeter module	<input type="checkbox"/>
Toggle cover	<input type="checkbox"/>
Sealing accessories	<input type="checkbox"/>
DIN rail adapter	NSX100/250 <input type="checkbox"/>
3P 60 mm busbar adapter	<input type="checkbox"/>

Plug-in/withdrawable configuration accessories

Auxiliary connections	1 automatic connector fixed part with 9 wires (for base)	<input type="checkbox"/>
	1 automatic connector moving part with 9 wires (for circuit breaker)	<input type="checkbox"/>
	1 support for 3 automatic connector moving parts	<input type="checkbox"/>
	1 support for 2 automatic connector	<input type="checkbox"/>
	9-wire manual auxiliary connector (fixed + moving)	<input type="checkbox"/>

Plug-in base accessories	Long insulated terminals	<input type="checkbox"/>	Set of 2
	2 IP4 shutters for base	<input type="checkbox"/>	
Chassis accessories	Escutcheon collar	Toggle <input type="checkbox"/>	Vigi <input type="checkbox"/>
	Locking kit (keylock not included)	<input type="checkbox"/>	
	2 carriage switches (conn./disconnected position indication)	<input type="checkbox"/>	
Parts or plug-in	Plug-in base FC/RC	2P <input type="checkbox"/>	3P <input type="checkbox"/>
			4P <input type="checkbox"/>
Withdrawable kits	Set of two power connections	Standard <input type="checkbox"/>	Vigi <input type="checkbox"/>
	Safety trip for advanced opening	<input type="checkbox"/>	
	For 3P/4P chassis	<input type="checkbox"/>	Moving part <input type="checkbox"/>
			Fixed part <input type="checkbox"/>
Adapter for plug-in base (for terminal shield or interphase barriers)	<input type="checkbox"/>		

Communication

NSX Cord L = 0.35 m	<input type="checkbox"/>	NSX Cord L = 1.3 m	<input type="checkbox"/>
NSX Cord U > 480 V AC L = 0.35 m	<input type="checkbox"/>	NSX Cord L = 3 m	<input type="checkbox"/>

BSCM	<input type="checkbox"/>		
Communicating motor mechanism 220-240 V	<input type="checkbox"/>		
Switchboard front display module FDM121	<input type="checkbox"/>		
FDM mounting accessory	<input type="checkbox"/>		
Ethernet Interface + Gateway	<input type="checkbox"/>		
Ethernet Interface	<input type="checkbox"/>		
Modbus interface	<input type="checkbox"/>		
I/O Application Module	Qty 1 <input type="checkbox"/>		
	Qty 2 <input type="checkbox"/>		
Stacking accessory	<input type="checkbox"/>		
ULP line termination	<input type="checkbox"/>		
RJ45 connectors female/female	<input type="checkbox"/>		
Wire length RJ45 L = 0.3 m	<input type="checkbox"/>	Wire length RJ45 L = 0.6 m	<input type="checkbox"/>
Wire length RJ45 L = 1 m	<input type="checkbox"/>	Wire length RJ45 L = 2 m	<input type="checkbox"/>
Wire length RJ45 L = 3 m	<input type="checkbox"/>	Wire length RJ45 L = 5 m	<input type="checkbox"/>

Life Is On



Schneider Electric Industries SAS

35, rue Joseph Monier
CS 30323
92506 Rueil Malmaison Cedex
France

RCS Nanterre 954 503 439
Capital social 928 298 512 €
www.se.com

05-2021

© 2021 - Schneider Electric. All Rights Reserved.
All trademarks are owned by Schneider Electric Industries SAS or its affiliated companies.
Document reference: LVPED221001EN